

User Manual

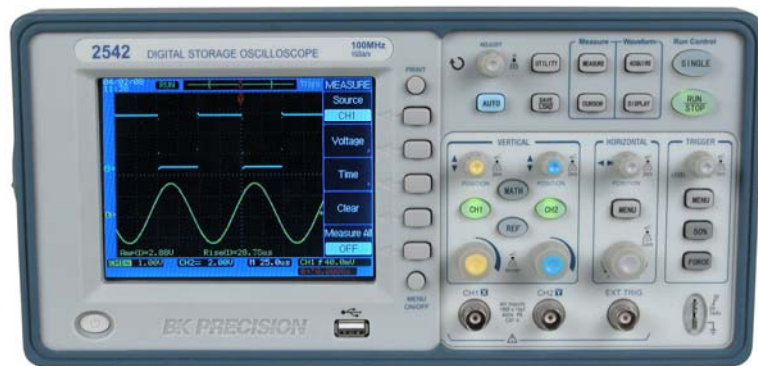

Digital Storage Oscilloscopes Models 2534, 2540 & 2542



Version 1.03

General Safety Summary

Review the following safety precautions to avoid injury and prevent damage to this product or any products connected to it. To avoid potential hazards, use this product only as specified.

Only qualified personnel should perform service procedures.

To Avoid Fire or Personal Injury

Use Proper Power Cord. Use only the power cord specified for this product and certified for the country of use.

Connect and Disconnect Properly. Do not connect or disconnect probes or test leads while they are connected to a voltage source.

Ground the Product. This product is grounded through the grounding conductor of the power cord. To avoid electric shock, the grounding conductor must be connected to earth ground. Before making connections to the input or output terminals of the product, ensure that the product is properly grounded.

Connect the Probe Properly. The probe ground lead is at ground potential. Do not connect the ground lead to an elevated voltage.

Observe All Terminal Ratings. To avoid fire or shock hazard, observe all ratings and marking on the product. Consult the product manual for further ratings information before making connections to the product.

Do Not Operate Without Covers. Do not operate this product with covers or panels removed.

Avoid Exposed Circuitry. Do not touch exposed connections and components when power is present.

Do Not Operate With Suspected Failures. If you suspect there is damage to this product, have it inspected by qualified service personnel.

Do Not Operate in Wet/Damp Conditions.

Do Not Operate in an Explosive Atmosphere.

Keep Product Surfaces Clean and Dry.

Symbols and Terms on the Product.



Protective Ground (Earth) Terminal.



CAUTION. Refer to user manual. Caution indicates a hazard to property including this product

Contents

Contents

Contents	5
1. Getting Started	7
Inspect package content	7
Front Panel	8
Rear panel	14
Interpreting the display	15
2. Basic Operation	17
Probe Compensation	17
Using Autoset	18
Vertical Controls	20
CH1, CH2 Menu	22
REF Function	39
Horizontal Controls	42
Trigger Controls	55
ACQUIRE Menu	67
UTILITY Menu	78
MEASURE Menu	91
SAVE/LOAD Menu	106
CURSOR Menu	117
DISPLAY Menu	123
RUN Controls	126
3. Application Examples	129
Make Simple Measurements	129

Contents

Capture a Single-Shot Signal	131
Reduce the Random Noise on a Signal	133
Trigger on a Video Signal	135
PASS/FAIL Measurement	138
Waveform Recorder	140
Cursor Measurements	144
4. System Message and General Problems	151
System Message	151
General Problems	154
5. Specifications and Characteristics	157
Characteristics	157
Appendix A: Service and Warranty Information	165

1. Getting Started

Inspect package content

Inspect the shipping container for damage. If the shipping container and/or packaging material are damaged, it should be kept until the content of the shipment has been checked for completeness and the oscilloscope has been checked mechanically and electrically.

Verify that you received the following items:

- Oscilloscope
- Two high performance 150MHz oscilloscope probes
- Power cord
- User Manual
- Test report
- Comsoft Installation disk
- USB data cable

If the content is incomplete or if there is any mechanical damage or defect, please contact your authorized distributor.

Front Panel

This section provides an introduction to the front panel of the model 2534 and 2540 series oscilloscopes. Generally, you set up the front panel controls first and then make your measurements.

The keys or knobs on the front panel bring up softkey menus on the display that provide further access to the oscilloscope's features. The entry knob  is usually used to select or change values. Five softkeys are located along the right side of the display screen.

The following figure shows the front panel of the 2534/2540 series oscilloscopes.

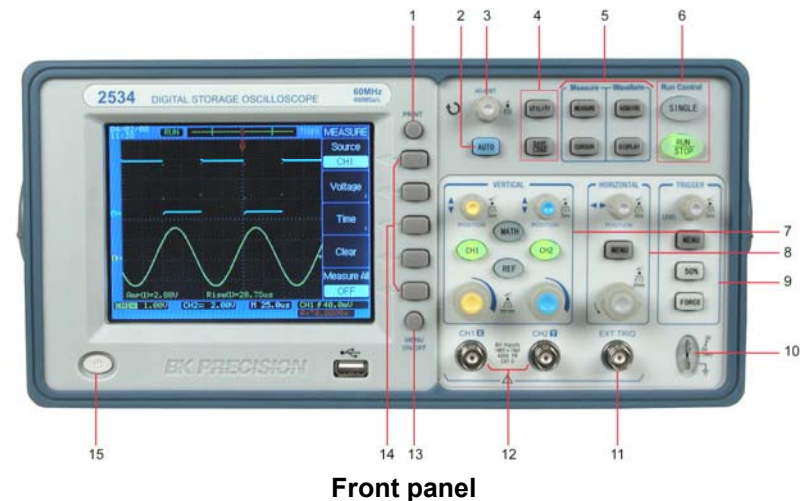

Getting Started

1. **PRINT** key

Press this key to print the current display to a USB mass storage device.

2. **AUTO** key

When you press the **AUTO** key, the oscilloscope will quickly determine which channels are active and automatically scale the display to show the signals on these channels.

3. **Entry knob**

The Entry knob is used to select items from menus and input values. Its function changes when a different menu is displayed. The curved arrow symbol  to the left of the Entry knob lights up when the Entry knob is active and can be used to select a value.

4. **Utility and Save/Load Menu**

UTILITY

Access the system utility functions, such as Language Setup, I/O Setup, and Print Setup etc.

SAVE/LOAD

You can save your current setup and waveform data to the oscilloscope's internal memory or to a USB mass storage device and retrieve the setup or waveform later.

5. **Measure and Waveform Menu**

MEASURE

Getting Started

Perform automated measurements of waveform parameters.

ACQUIRE

The ACQUIRE menu lets you set the oscilloscope to acquire waveforms in Normal, Peak Detect, or Average mode and lets you select Real Time or Equivalent sampling.

CURSOR

Press the **CURSOR** key to activate the cursors for making custom voltage or time measurements on scope signals.

DISPLAY

You can change the appearance of waveforms and the display screen, select the color schemes, and adjust the contrast, etc.

6. **RUN control keys**

The **RUN/STOP** key will be green when the oscilloscope is waiting for a trigger event. When the trigger mode is set to Normal, the display will not update until a trigger event occurs. If the trigger mode is set to Auto, the oscilloscope looks for a trigger; if no trigger is found, it will be triggered automatically and the input signals will be displayed.

Getting Started

Press the **RUN/STOP** key again to stop acquiring data. The **RUN/STOP** key will be red. Now you may examine the acquired waveform by panning and zooming.

Press the **SINGLE** key to acquire a single waveform trace. The key will remain orange until the oscilloscope is triggered. After the trigger event, the waveform is displayed and triggering is disabled until re-armed by pressing the **SINGLE** key again.

7. Vertical controls

You can use the vertical position control knob to move the waveforms up or down on the display. There is one vertical position control knob for each channel.

You can press the channel key **CH1** or **CH2** to switch the channel on or off or access the associated channel menu via the softkeys. There is one channel on/off key for each channel.

You can press the **MATH** key to access the FFT (Fast Fourier Transform), multiply, subtract, and add functions.

You can press the **REF** key to save or load a reference waveform from the internal memory or an external USB mass storage device.

You can use the vertical scale control knob to change the vertical scale of a waveform. The waveform display will

Getting Started

contract or expand relative to the ground reference level. There is one vertical scale control knob for each channel.

8. Horizontal controls

When the oscilloscope is in run mode, the horizontal position control knob lets you set the acquisition window relative to the trigger point. When acquisition is stopped, you can turn this knob to pan through the stored waveform data horizontally. This lets you see the captured waveform before or after the trigger.

Press the horizontal **MENU** key to access the menu where you can activate a delayed sweep or select X-Y or Roll modes.

Turn the horizontal sweep rate control knob to adjust the sweep speed. This changes the time base on the display. When adjusted after the waveform has been acquired and the oscilloscope is stopped, this has the effect of stretching or compressing the waveform horizontally.

9. Trigger controls

These controls are used to control how the oscilloscope triggers to capture waveforms.

10. Probe compensation terminals

Getting Started

Use these two probe compensation terminals to match each probe's characteristics to the oscilloscope channel to which it is connected.

11. External trigger input

This is the external trigger input BNC connector.

12. Channel input BNC

This is the channel's input BNC connector. Connect the oscilloscope probe or BNC cable to the BNC Connector.

13. **MENU On/Off** key

Press this key to toggle the menu display on and off.

14. Softkeys

Five menu softkeys are used to select the control and parameter setting functions. Each softkey has a label along the right side of the screen.

15. Power switch

Press once to turn power on, press again to turn power off.

16. LCD display

The 320*240 matrix (5.7 inch) LCD displays captured waveforms, setup information, measurement results, and softkeys for setting up parameters.

Getting Started

Rear panel

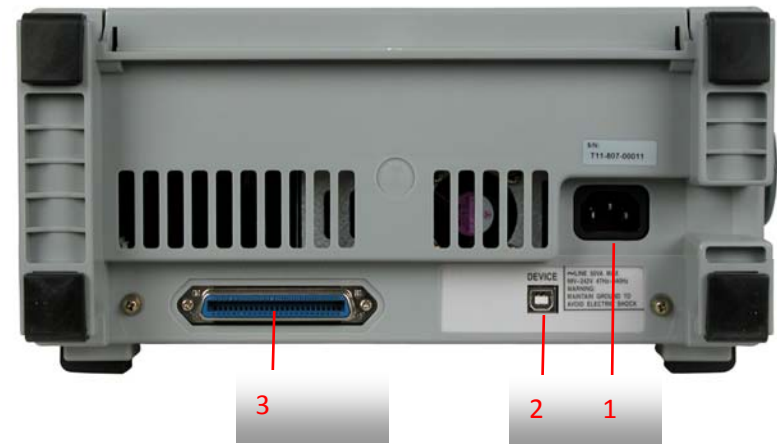

Rear panel

1. Line input receptacle

AC power cord receptacle. Attach to an AC power line with a safety ground.

2. USB connector

The USB device connector can be connected to a computer.

3. Extension port

Connect optional extension communication modules. Contact B&K Precision for availability.

Interpreting the display

The oscilloscope display contains channel acquisition information, setup information, measurement results, and soft keys for setting up measurement parameters.

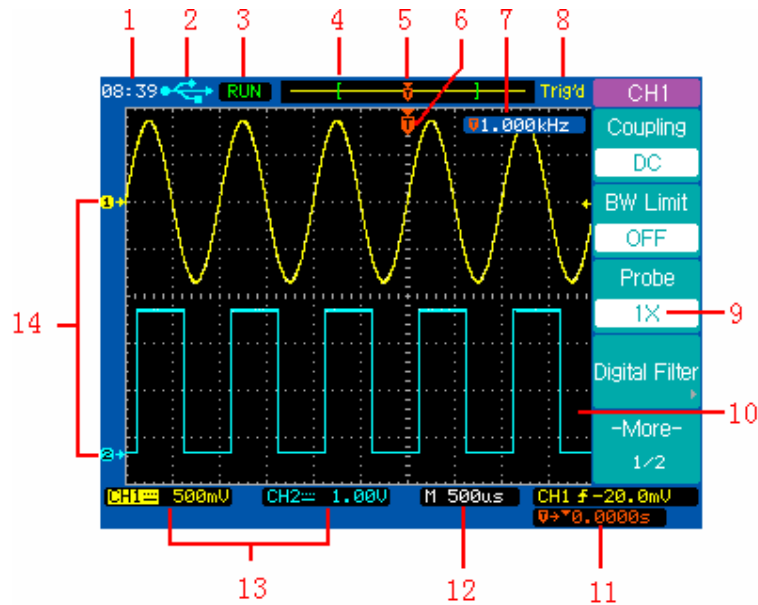

Interpreting the display

1. Readout shows the real time clock.
2. The USB icon displays when a USB device is connected.
3. Acquisition status readout shows RUN, STOP, WAIT, or ROLL.
4. The square brackets show the location of the current display window within the recorded waveform. The

record line color corresponds to the selected waveform color.

5. The trigger position icon shows the trigger location within the record.
6. The trigger position icon shows the trigger location in the current displayed waveforms.
7. This readout shows the frequency of the trigger signal.
8. The trigger status readout shows the trigger status.
9. These are soft keys which allow you to set up additional parameters.
10. The display area contains the displayed waveforms, channel identifiers, and trigger and ground level indicators. The channel information is shown in the same color as the channel's waveform.
11. This readout shows the delay setting or the trigger location within the record, trigger source, trigger type, and trigger level.
12. The horizontal readout shows the Main or Delayed time base setting.
13. The channel readouts show the scale factor, coupling, bandwidth limit, digital filter, and invert status.
14. Waveform baseline icons show the zero-volt levels of the waveforms. The icon colors correspond to the waveform colors.

2. Basic Operation

Probe Compensation

Perform this adjustment to match your probe to the input channel. This should be done whenever you attach a passive probe for the first time to any input channel. A poorly compensated probe can introduce measurement errors.

1. Connect the oscilloscope probe to channel 1. Connect the probe tip to the 3Vp-p@1kHz terminal and connect the probe's ground lead to the chassis ground terminal, then press the **AUTO** key.
2. Use a nonmetallic tool to adjust the trimmer capacitor on the probe for the flattest pulse possible. The trimmer capacitor is located on the probe BNC connector.

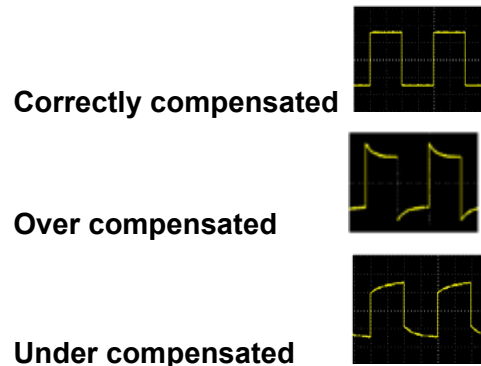

3. Connect probes to all other oscilloscope channels. Repeat the procedure for each channel. This matches each probe to each channel.

Using Autose

The 2534 & 2540 series digital storage oscilloscopes provide the Autose function which sets the vertical, horizontal, and trigger controls automatically.

Autose function finds, turns on, and scales any channel with a repetitive waveform that has a frequency of at least 50 Hz, a duty cycle greater than 0.5% and an amplitude of at least 10 mV peak-to-peak. Any channels that do not meet these requirements are turned off.

When you are using more than one channel, the Autose function sets the vertical controls for each channel and uses the lowest-numbered active channel to set the horizontal and trigger controls.

To configure the oscilloscope quickly and automatically, press the **AUTO** key to display the connected signals that are active.

To configure the oscilloscope to display multiple cycles, press the **Multi-Cycle** softkey in the **AUTO** menu.

To configure the oscilloscope to display a single cycle, press the **Single Cycle** softkey in the **AUTO** menu.

Basic Operation

To undo the effects of Autoset, press the **Undo Autoset** softkey in the **AUTO** menu before pressing any other key. This is useful when you have unintentionally pressed the **AUTO** key or do not like the settings Autoset has selected and want to return to your previous settings.

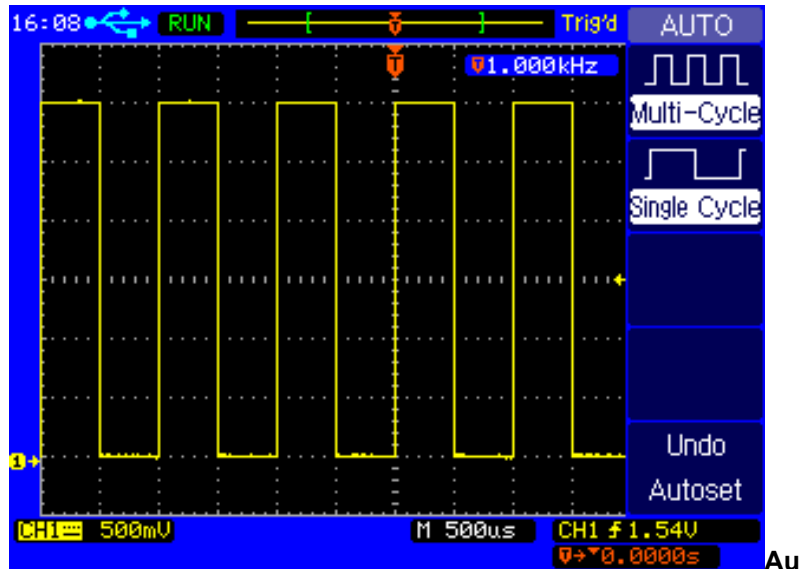

to set oscilloscope channel 1

Basic Operation

Vertical Controls

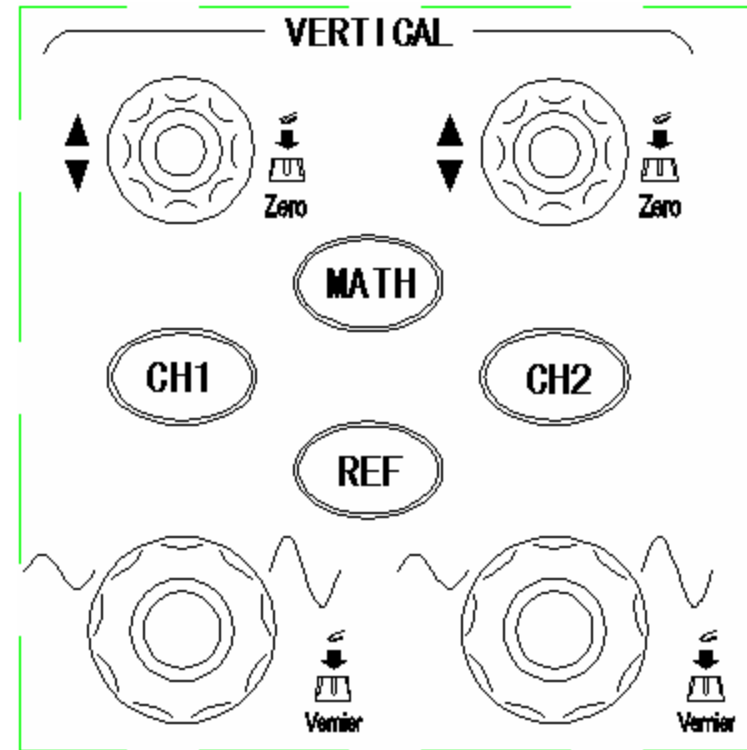

Vertical controls

Vertical Position Control (CH1, CH2)

Turn the small vertical position knob above the channel key to move the channel's waveform and its ground level icon (Ⓢ+) up or down on the display. The voltage value momentarily displayed in the bottom left portion of the display represents

Basic Operation

the voltage difference between the vertical center of the display and the ground level(Ⓢ+).

Press the small vertical position knob above the channel key to bring the channel's waveform and its ground level icon (Ⓢ+) directly back to the vertical center of the display.

Channel key **CH1**, **CH2**, **MATH**, **REF**

Press the channel key from the front panel to display the channel's menu. Pressing it again turns the display of the channel on or off. The channel is displayed when the key is illuminated.

You must be viewing the menu for a channel before you can turn it off. For example, if CH1 and CH2 are both displayed and the **CH2** menu is now displayed. In order to turn **CH1** off, you should press the **CH1** key first and **CH1** menu will be displayed; then press **CH1** key again to turn off **CH1**.

Vertical Scale Control (CH1, CH2)

Turn the large vertical scale knob below the channel key to set the scale factor for the channel. The vertical scale knob changes the channel scale in a 1-2-5 step sequence. The scale factor value is displayed in the bottom left portion of the display.

Press the large vertical scale knob to toggle between Fine and Coarse. When fine is selected, you can change the channel's vertical sensitivity in smaller steps. This is useful when you want to scale the displayed waveform to an exact

Basic Operation

size. When coarse is selected, the vertical scale knob changes the channel scale in a 1-2-5 step sequence.

CH1, CH2 Menu

Press the channel key **CH1** to display the channel's menu and turn the display of the channel on.

Channel Coupling

Press the channel key **CH1**, then press the **Coupling** softkey to select AC coupling mode.

AC coupling places a high pass filter in series with the input waveform that blocks the DC component of the input signal. AC coupling is useful for viewing waveforms with DC offsets.

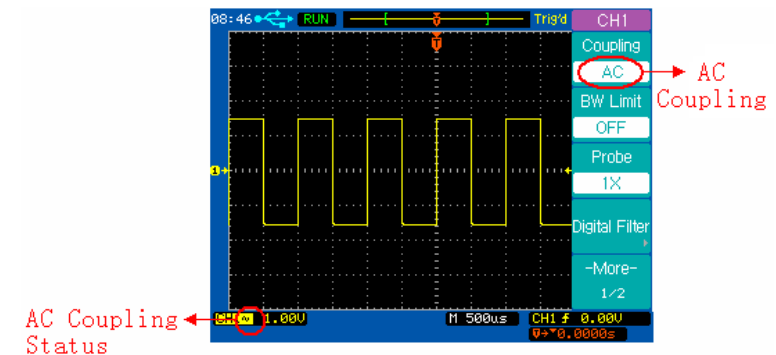

AC Coupling

Basic Operation

Press the channel key **CH1**, then press the **Coupling** softkey to select DC coupling mode.

DC coupling passes both AC and DC components of the input signal. DC coupling is useful for viewing low frequency waveforms that do not have large DC offsets.

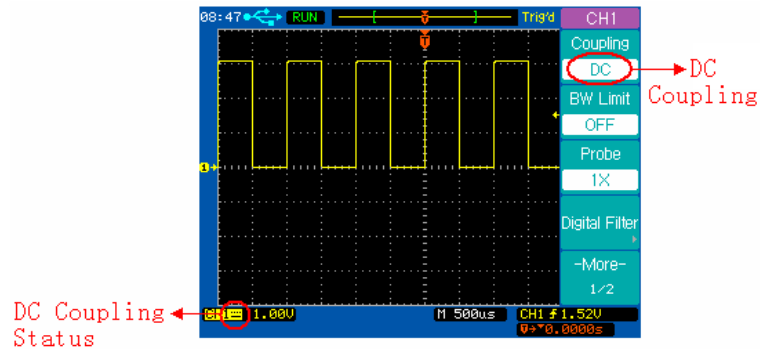

DC Coupling

Basic Operation

Press the channel key **CH1**, then press the **Coupling** softkey to select GND coupling mode.

GND mode blocks both AC and DC components of the input signal by grounding the channel amplifier's input.

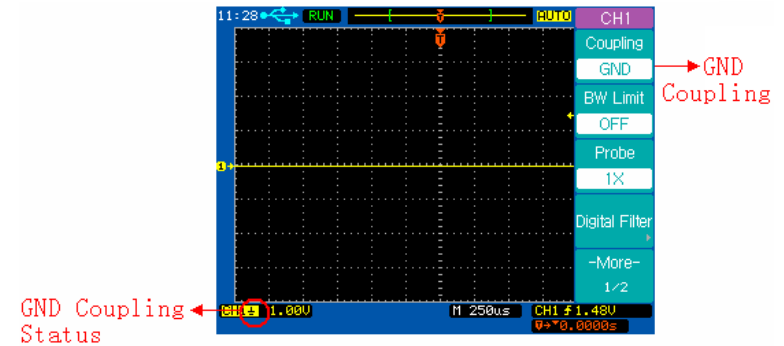

GND Coupling

Basic Operation

Bandwidth Limit

When Bandwidth limit is on, the maximum bandwidth for the channel is approximately 20 MHz. For waveforms with frequencies below this, turning bandwidth limit on removes unwanted high frequency noise from the waveform. The bandwidth limit also limits the trigger signal path's bandwidth of any channel that has **BW Limit** turned on.

Press the channel key **CH1**, then press the **BW Limit** softkey to turn the bandwidth limit off for the selected channel 1. BW Limit off mode passes both the high and low frequency components.

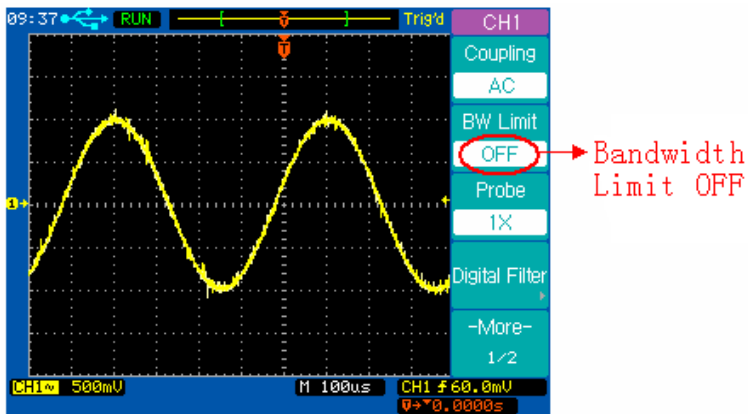

BW Limit off

Basic Operation

Press the channel key **CH1**, then press the **BW Limit** softkey to turn the bandwidth limit on for the selected channel 1. BW Limit on mode blocks the high frequency components over 20MHz.

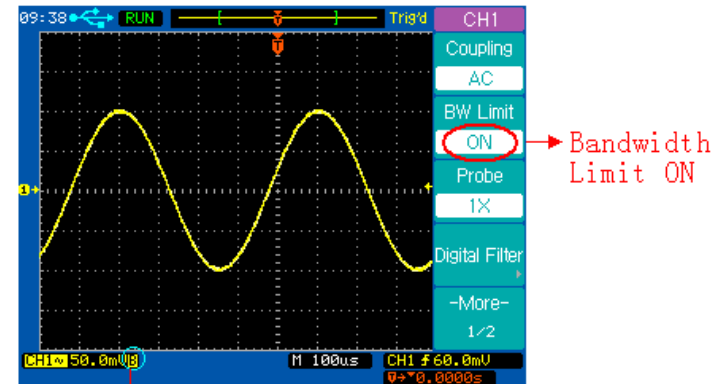

Bandwidth Limit ON Status

BW Limit on

Probe Attenuation Setting

Probes are available with various attenuation factors which affect the vertical scale of the signal. You can manually select the factor that matches the attenuation of your probe. This allows you to see the correct measured values for waveforms.

For example, to match a probe set to 1X connected to CH1, press the channel key **CH1**, and then press the **Probe** softkey and select 1X.

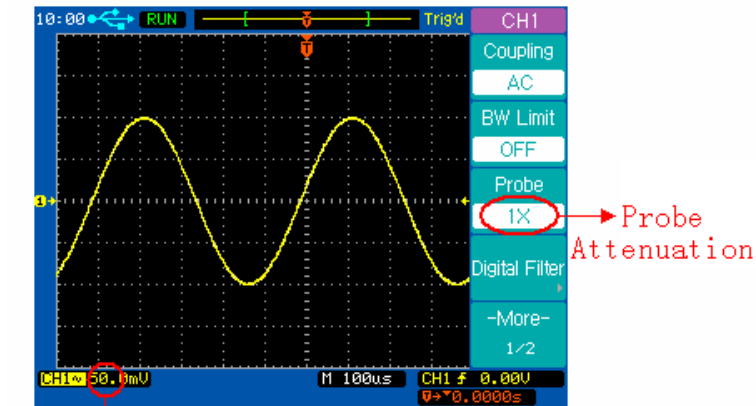

Vertical Scale

Set Probe Attenuation Factor to 1X

Digital Filter

Press the channel key **CH1**, then press the **Digital Filter** softkey to display the **FILTER-CH1** menu. Four kinds of filter types are available:

- Low pass filter
- High pass filter
- Band pass filter
- Notch filter

Press the **Upper Limit** or **Lower Limit** softkey and then adjust the Entry knob to set the high and low frequency range for the filter.

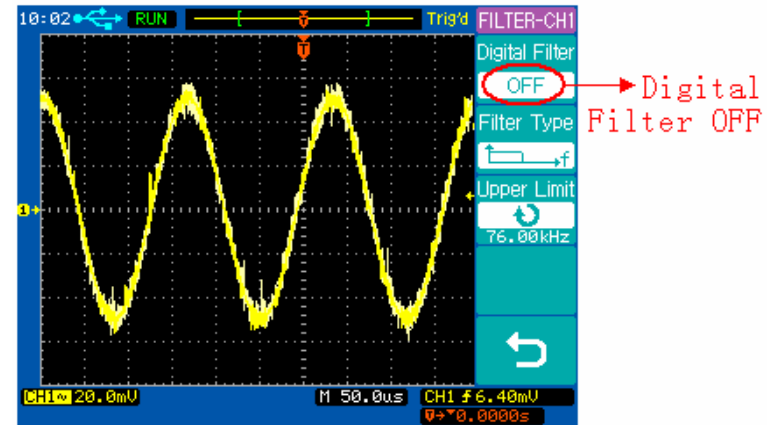

Digital Filter is off

Basic Operation

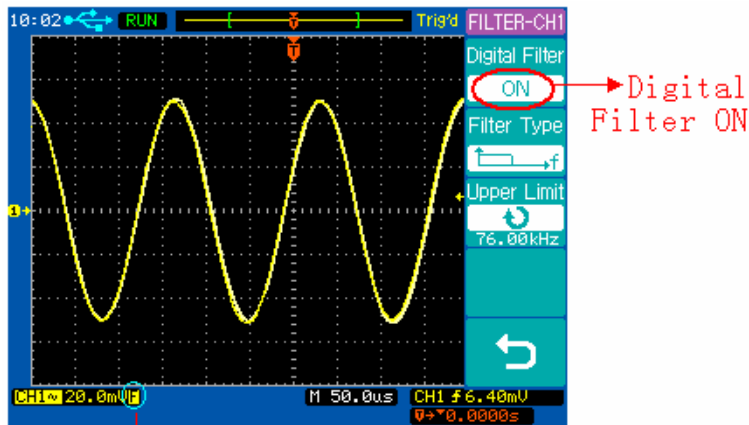

Digital Filter ON

Filter Status

Digital Filter is on

Basic Operation

Vertical Scale

Turn the large vertical scale knob below the channel key to set the scale factor for the channel. The channel scale factor value is displayed in the bottom left portion of the display.

Press **CH1** → **More 1/2** → **Volts Scale** to select **Coarse** or **Fine** adjustment. You can also press the large vertical scale knob to toggle between **Coarse** and **Fine**. When Coarse is selected, the vertical scale knob changes the channel scale in a 1-2-5 step sequence. When Fine is selected, the vertical scale knob changes the channel scale using a smaller step size.

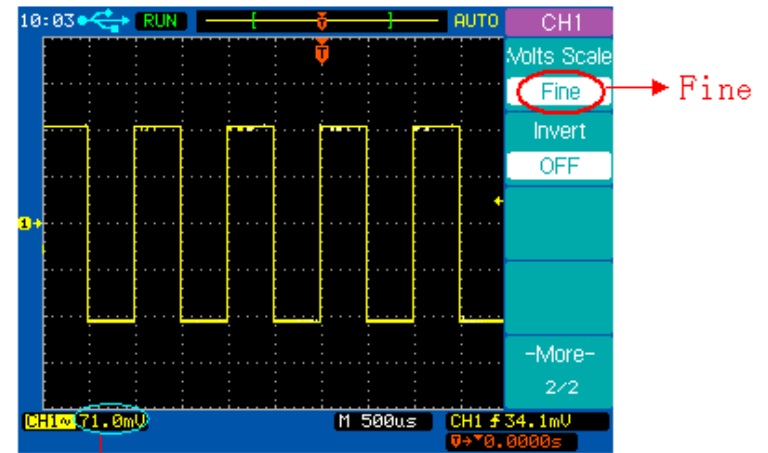

Fine

Fine Value

Fine Vertical Scale

Basic Operation

Vertical Invert

Press **CH1** → **More 1/2** → **Invert** to turn Invert on or off. When Invert is turned on, the voltage values of the displayed waveform are inverted. Invert affects how a channel is displayed, but does not affect triggering. If the oscilloscope is set to trigger on a rising edge, it remains set to trigger on a same edge after the channel is inverted. If the signal is represented as $f(t)$, then inverting the signal displays $-f(t)$. Inverting a channel will also change the result of any function selected in the **MATH** menu or any measurement.

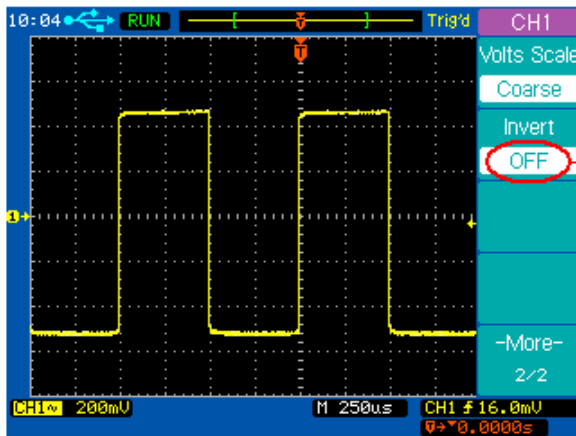

Vertical Invert off

Basic Operation

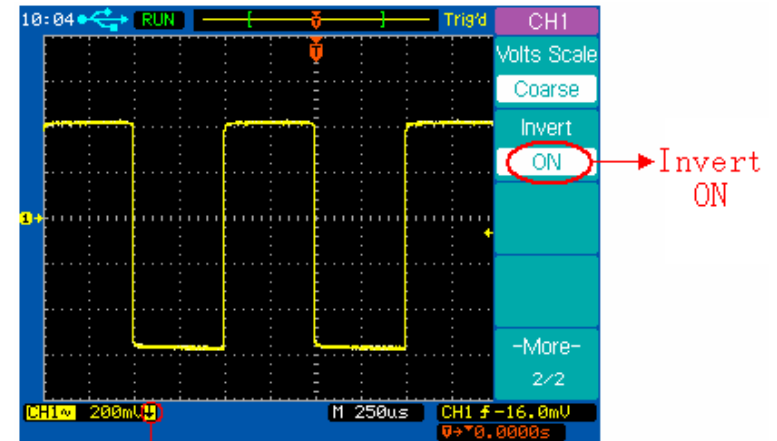

Inversion Status

Vertical Invert on

Basic Operation

MATH Functions

Dual Waveform Calculation

Press the **MATH** channel key to turn on the **MATH** menu page 1/2.

MATH	Softkey	Options	Description
Operate	Operate	A+B	Add A and B
A+B		A-B	Subtract B from A
Source A		A×B	Multiply A by B
CH1		FFT	Access FFT menu
Source B	Source A	CH1	Select CH1 as Source A
CH2		CH2	Select CH2 as Source A
Invert	Source B	CH1	Select CH1 as Source B
OFF		CH2	Select CH2 as Source B
-More- 1/2	Invert	ON	Invert ON
		OFF	Invert OFF
	More 1/2	----	Select page 2/2

Basic Operation

Press the softkey **More ½** to display the **MATH** menu page 2/2.



Softkey	Options	Description
Operate	A+B	Add A and B
	A-B	Subtract B from A
	A×B	Multiply A by B
	FFT	Access FFT menu
Display Mode		Vertical scale control
		Vertical position control
Display Mode	Split Screen	Split the display into Main and Math sections
	Full Screen	Display Math waveform in full screen
More 2/2	----	Select page 1/2

Basic Operation

For example, we select the A+B math function, select CH1 as the Source A, and select CH2 as the Source B, then we will see the math waveform displayed in red as follows:

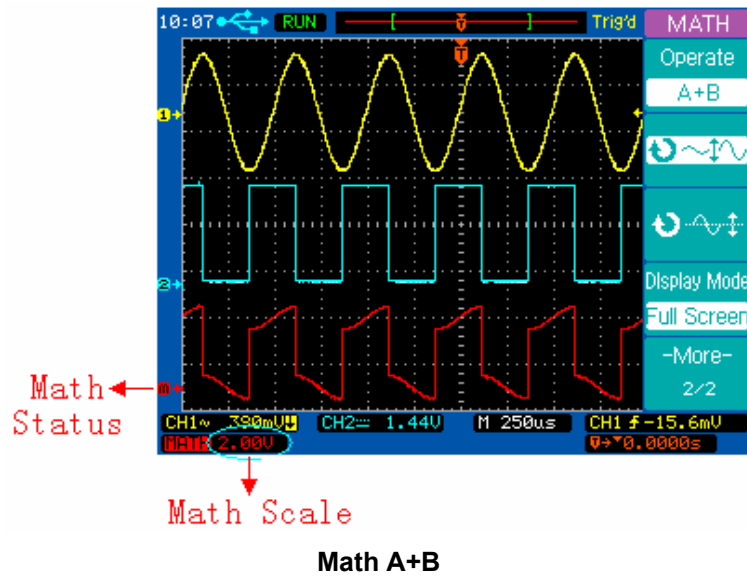

FFT Spectrum Analysis

You can use the FFT function to measure, for example, the harmonic content and distortion in systems, to characterize noise in DC power supplies, and to analyze vibration.

Basic Operation

Press the **MATH** key to turn on the **MATH** menu page 1/2, and then press the **Operate** softkey to select FFT. The **FFT** menu page 1/2 will be displayed.

FFT	Softkey	Options	Description
Operate	Operate	A+B	Add A and B
		A-B	Subtract B from A
		A×B	Multiply A by B
		FFT	Enter FFT menu
Source	Source	CH1	Select CH1 for FFT
		CH2	Select CH2 for FFT
Window	Window	Hanning	Use Hanning window
		Hamming	Use Hamming window
		Blackman	Use Blackman window
		Flattop	Use Flattop window
		Rectangular	Use Rectangular window
Scale	Scale	dBV RMS	Vertical scale in dBV RMS
		V RMS	Vertical scale in V RMS
More 1/2	More 1/2	----	Select page 2/2

Basic Operation

Press the softkey **More 1/2** to display the **FFT** menu page 2/2.

Softkey	Options	Description
Operate	A+B	Add A and B
	A-B	Subtract B from A
	AxB	Multiply A by B
	FFT	Enter FFT menu
Display Mode		Vertical scale control
		Vertical position control
Display Mode	Split Screen	Split the display into Main and Math sections
	Full Screen	Display Math waveform in full screen
More 2/2	----	Select page 1/2

Basic Operation

For example, we select CH1 as the source for the FFT, select the rectangular window, set the vertical scale to dBV RMS, and then we will get an FFT waveform similar to the following figure. We can also measure the amplitude and frequency of FFT points with the manual cursors (see chapter application examples, example “measure Frequency and Amplitude of a FFT waveform”)

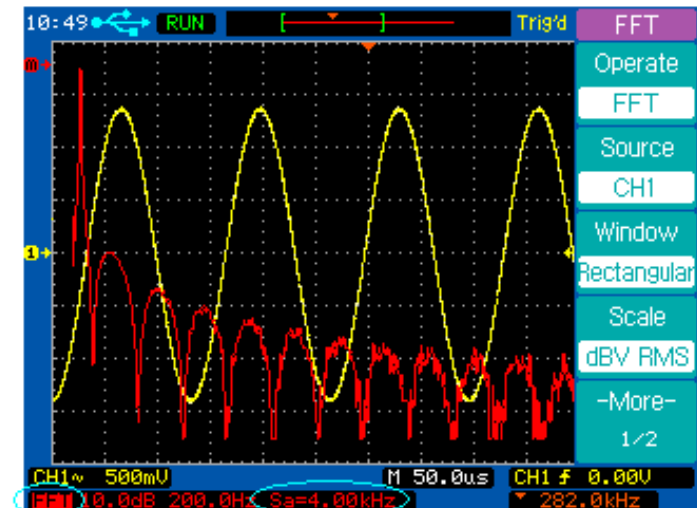

FFT Status Sample Rate

FFT Spectrum Analysis

REF Function

You might make measurement on a known good system, save the result to internal memory or to a USB mass storage device, then make the same measurement on a test system and recall the reference waveform to see the difference.

Press the **REF** channel key to turn on the **REF** menu page 1/2.

REF	Softkey	Options	Description
Source	Source	CH1	Save CH1 as reference
CH1		CH2	Save CH2 as reference
			REF vertical scale control
			REF vertical position control
Invert	Invert	ON	REF invert ON
		OFF	REF invert OFF
More 1/2	More 1/2	----	Select page 2/2

Press the softkey **More 1/2** to display **REF** menu page 2/2.

REF	Softkey	Options	Description
Internal Storage	Internal Storage	INTERNAL menu	Save the reference waveform to internal memory.
External Storage	External Storage	EXTERNAL menu	Save the reference waveform to a USB mass storage device.
More 2/2	More 2/2	----	Select page 1/2

Press **REF** channel key to turn on the **REF** menu page 1/2 and load the latest saved reference waveform at the same time from the internal memory.

You can use the horizontal position and scale control knob to change the time base of the reference waveform.

Press or softkey and turn the Entry knob to change the vertical scale or position of the reference waveform.

Basic Operation

Press **REF** → **Internal Storage** → **Save** to save the waveform of the Source channel as the reference waveform to internal memory.

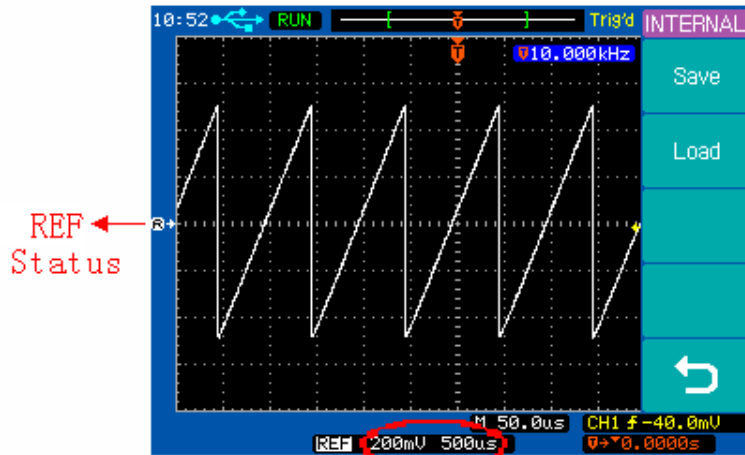

REF Scale Value

Save a Reference waveform

Note: The reference waveform function is unavailable when X-Y mode is selected.

Basic Operation

Horizontal Controls

Use the horizontal controls to adjust the time base, adjust the trigger location, and to examine waveform details more closely.

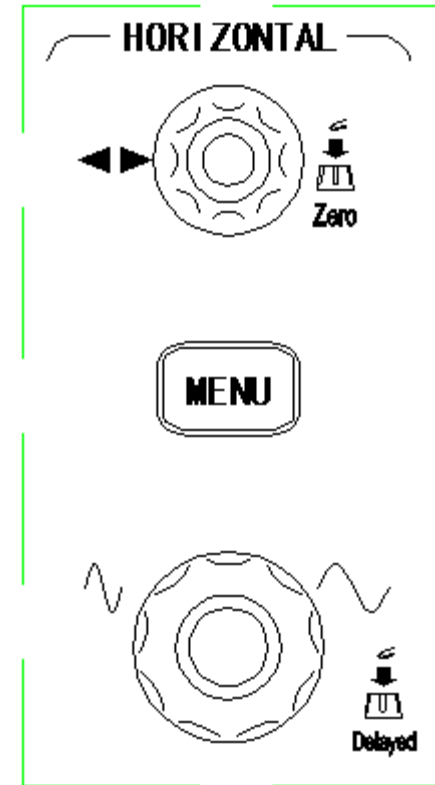

Horizontal Controls

Horizontal Position Control

When the oscilloscope is in run mode, this control lets you set the acquisition window relative to the trigger point. When acquisition is stopped, you can turn this knob to pan through the data horizontally. This lets you see the captured waveform before the trigger or after the trigger.

The trigger position is marked with the letter “T” at the top of the graticule and also in the waveform record icon at the top of the screen.

The small inverted triangle is the time reference indicator. When you change the horizontal scale, the waveforms contract or expand about this point.

Press the horizontal position control knob to set the time delay to zero. Then the trigger position indicator (▼) overlays the time reference indicator(▼).

Note: The horizontal position control is unavailable when X-Y horizontal mode is selected.

Horizontal Scale Control

Use the horizontal scale control to adjust the time base. The scale expands or contracts around the center of the screen. The horizontal scale factor can be set in a 1-2.5-5 sequence (2534) or in a 1-2-5 sequence (2540/2542).

Press the horizontal scale control knob to toggle between Main and Delayed horizontal mode.

Horizontal **MENU** key

Press the horizontal **MENU** key to display the **HORIZONTAL** menu. This menu lets you select the horizontal mode: **Main**, **Delayed**, **Roll**, or **X-Y**, and set the **Holdoff** time.

Press the horizontal **MENU** key to display the **HORIZONTAL** menu page 1/2.

HORIZONTAL	Softkey	Options	Description
Main ✓	Main	√	Main mode is ON
		----	Main mode is OFF
Delayed	Delayed	√	Delayed mode is ON
		----	Delayed mode is OFF
X-Y	X-Y	√	X-Y mode is ON
		----	X-Y mode is OFF
Roll	Roll	√	Roll mode is ON
		----	Roll mode is OFF
-More- 1/2	-More- 1/2	----	Select page 2/2

Basic Operation

Press the softkey **More 1/2** to display the **HORIZONTAL** menu page 2/2.

HORIZONTAL	Softkey	Options	Description
Holdoff 100ns	Holdoff	↻	Set the holdoff time between two triggers.
Holdoff Reset	Holdoff	----	Reset the holdoff time to the default value of 100 ns.
Trig-Offset Reset	Reset	----	Reset the delay time to zero.
-More- 2/2	Trig-Offset	----	Reset the delay time to zero.
	Reset	----	Reset the delay time to zero.
	-More- 2/2	----	Select page 1/2

Main Horizontal Mode

The Main horizontal mode is the normal viewing mode for the oscilloscope. When acquisition is stopped, you can use the horizontal controls to pan and zoom the waveform. When the oscilloscope is operating in Main mode, use the horizontal scale knob to change horizontal scale factor and use the horizontal position knob to set the delay time. When the oscilloscope is stopped, use the horizontal control knobs to pan and zoom the waveform. The time base (second/division) value is displayed at the bottom of the screen.

Basic Operation

Press the horizontal **MENU** key and then press the **Main** softkey to select the main horizontal mode.

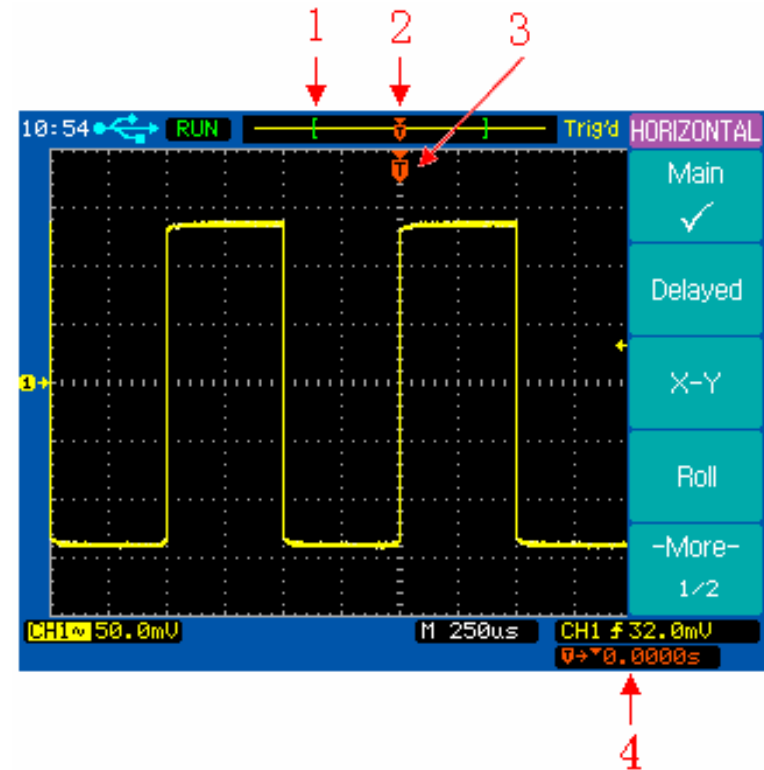

Main Horizontal Mode

1. The square brackets show the location of current display window within the record.
2. Trigger position within the record.
3. Trigger position on the current waveform display window.
4. Readout shows the delay time or the trigger location within the record relative to the time reference point (▼).

Delayed Horizontal Mode

Delayed horizontal mode is an expanded version of main mode. When Delayed mode is selected, the display divides in half. The top half of the display shows the normal waveform and bottom half displays the delayed waveform.

The Delayed waveform is a magnified portion of the normal waveform. You can use the delayed waveform to locate and horizontally expand part of the normal waveform for a more detailed analysis of the waveform.

The area of the normal display that is expanded is marked on each end of the trace with a colored area. The uncolored area shows what portion of the normal waveform is expanded in the lower half.

To change the time base for the delayed window, turn the horizontal scale knob. As you turn the knob, the time base for the delayed window is displayed just above the main time base.

To change the time base for the normal window, press the Main softkey, then turn the horizontal scale control knob.

To view the following figure, connect a triangle signal to CH1, press the horizontal **MENU** key and then press the **Delayed** softkey to enter the Delayed mode. You can also press the horizontal scale control knob to toggle between Main and Delayed mode directly.

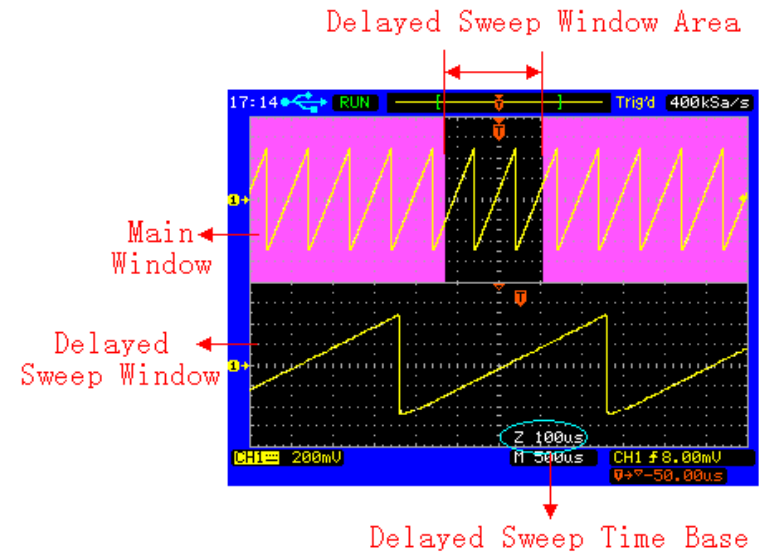

Delayed Horizontal Mode

X-Y Horizontal Mode

X-Y mode changes the display from a volts-versus-time display to a volts-versus-volts display. The time base is turned off. The CH1 signal is plotted on the X axis and CH2 signal is plotted on the Y axis.

You can use X-Y mode to compare the frequency and phase relationships between two signals. X-Y mode can also be used with voltage transducers to display, for example, strain versus displacement, flow versus pressure, volts versus current, or voltage versus frequency.

In order to get a better view of the waveform, the proper vertical scale should be selected before entering the X-Y mode.

Example: Use the X-Y mode to compare two signals with the

same frequency and different phase. Connect the two signals to CH1 and CH2 respectively. Press horizontal **MENU** key and then **X-Y** softkey to select X-Y mode. The displayed ellipse (a Lissajous figure) indicates the phase relationship of the two signals.

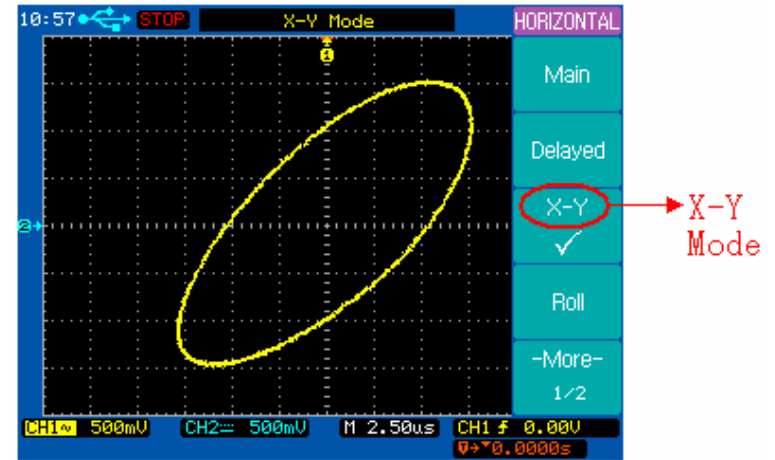

X-Y Horizontal Mode

Roll Horizontal Mode

Roll mode causes the waveform to move slowly across the screen from right to left. It only operates on time base settings of 500 ms/div or slower. If the current time base setting is faster than the 500 ms/div limit, it will be set to 500ms/div when Roll mode is selected.

In Roll mode there is no trigger. The fixed reference point on the screen is the right edge of the screen and refers to the current moment in time. Events that have occurred are scrolled to the left of the reference point. Since there is no trigger, no pre-trigger information is available.

If you would like to pause the display in Roll mode, press the **SINGLE** key. To clear the display and restart an acquisition in Roll mode, press the **SINGLE** key again.

Use Roll mode on low-frequency waveforms to yield a display much like a strip chart recorder. The waveform will “roll” across the display.

Press the horizontal **MENU** key and then press the **Roll** softkey to select the Roll mode. The waveform moves slowly across the screen from right to left.

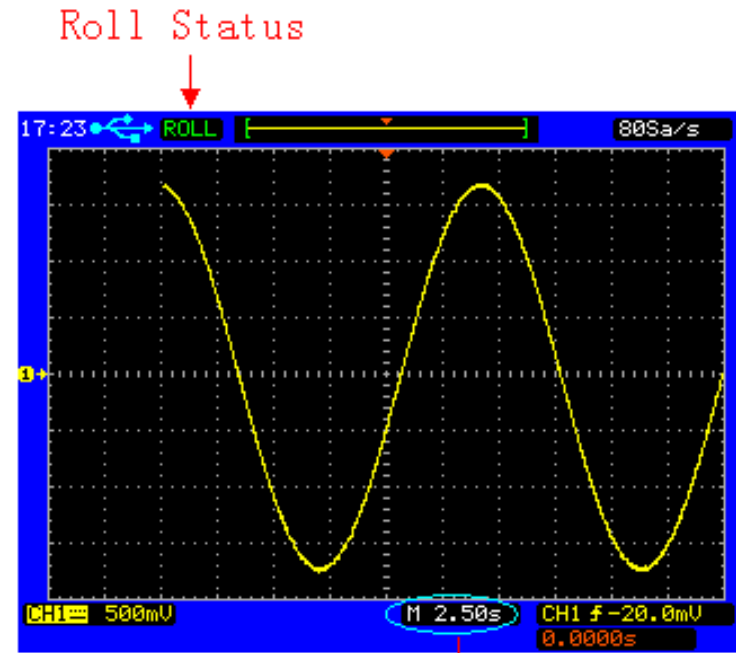

Horizontal Time Base

Roll Horizontal Mode

Holdoff Function

Holdoff sets the amount of time that the oscilloscope will wait before rearming the trigger circuit. You can use the holdoff function to stabilize the display of complex waveforms.

With the holdoff function, you can synchronize triggers. The oscilloscope will trigger on one edge of the waveform, and ignore further edges until the holdoff time is up. The oscilloscope will then rearm the trigger circuit to wait for the next edge trigger. This allows the oscilloscope to trigger on a repeating pattern in a complex waveform.

Turn the Entry knob to increase or decrease the trigger hold off time shown in the Holdoff softkey.

To get a stable trigger on the pulse burst shown on the screen, set the holdoff time to be slightly less than the period of the pulse burst.

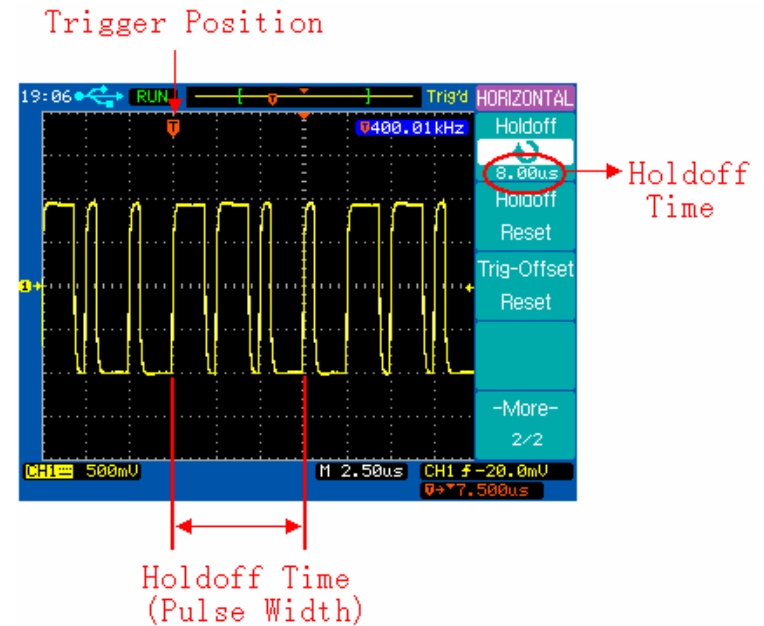

Holdoff Function

Trigger Controls

The trigger controls determine when the oscilloscope starts to acquire and display the waveform. When a trigger is found, the oscilloscope will acquire sufficient data to display the waveform. The trigger controls are functional when the oscilloscope is in Main or Delayed horizontal mode.



Trigger Controls

Trigger Control **MENU** key

Press the trigger control **MENU** key to show the **TRIGGER** menu and then press the **Type** softkey to select Edge, Pulse or Video.

Set to 50% key

Press the **50%** key to set the trigger level to the 50% amplitude level of the trigger source waveform.

Force Trigger key and secondary Local function

Press the **FORCE** key to force an immediate trigger event, even in the absence of a signal. This function is useful in the following situations.

If you do not see a waveform on the screen when using Normal trigger mode, press the **FORCE** key to see if the signal is on the screen (if not, you might have to adjust the vertical position).

After you press the **SINGLE** key to set up for a single shot acquisition, you can press the **FORCE** key to do a practice acquisition to verify the control settings.

When the instrument is in remote mode, pressing this button will revert the instrument to local mode. This function is useful to set the DSO back to local mode after exiting the Comsoft PC application.

Trigger Level Control

Use the trigger level control knob to adjust the trigger level. This is the voltage level on the trigger waveform that causes a trigger event. When you change the trigger level, a horizontal line temporarily appears to show you the trigger level on the screen. After the line disappears, the trigger level is marked with a small left arrow.

Auto and Normal Trigger Modes

Press the trigger **MENU** key to display the **TRIGGER** menu and press the **Mode** softkey to select Auto or Normal trigger mode.

Note: The Auto and Normal trigger mode are unavailable when the Video trigger type is selected.

Auto mode

Use the auto trigger mode for signals other than low repetitive-rate signals and for unknown signal levels. To display a DC signal, you must use Auto trigger mode since there is no edge to trigger on.

When you press the **RUN/STOP** key to start acquiring a waveform, the oscilloscope first fills the pre-trigger buffer. It then starts to search for a trigger after the pre-trigger buffer is filled and continues to flow data through this buffer while it searches for the trigger. While searching for the trigger, if the oscilloscope overflows the pre-trigger buffer, the first data put into the buffer is the first pushed out. When a trigger is found,

the pre-trigger buffer will contain the events that occurred just before the trigger. If no trigger is found, the oscilloscope generates a trigger and displays the data as though a trigger had occurred. In this case, the background of the Auto indicator at the top of the display will flash, indicating that the oscilloscope auto triggered.

When you press the **SINGLE** key, the oscilloscope will fill the pre-trigger buffer and continue to flow data through the pre-trigger buffer until the Auto trigger overrides the searching and forces a trigger. At the end of the trace, the oscilloscope will stop and display the results.

Normal mode

Use Normal trigger mode for low repetitive-rate signals or when Auto trigger is not required.

In Normal mode the oscilloscope must fill the pre-trigger buffer with data before it will begin searching for a trigger event. While searching for the trigger, if the oscilloscope overflows the pre-trigger buffer; the first data put into the buffer is the first pushed out.

When the trigger event is found, the oscilloscope will fill the post-trigger buffer and display the results. If the acquisition was initiated by **RUN/STOP**, the process repeats. If the acquisition was initiated by **SINGLE**, then the acquisition stops.

Basic Operation



In either Auto or Normal mode, the trigger may be missed. This is because the oscilloscope will not recognize a trigger event until the pre-trigger buffer is full.

Video Trigger

Choose video triggering to trigger on the odd fields, even fields, or on all the lines of a NTSC or PAL/SECAM video signal.

Press the trigger control **MENU** key to display the **TRIGGER** menu, then press the **Type** softkey to select Video trigger.

Basic Operation

Softkey	Options	Description
Type	Video	Video triggering
	Edge	Edge triggering
	Pulse	Pulse width triggering
Source	CH1	Trigger on CH1
	CH2	Trigger on CH2
	EXT	Trigger on EXT
	EXT/5	Trigger on EXT/5
	Alternating	Trigger on CH1 and CH2 alternately
Polarity		Positive polarity
		Negative polarity
Sync	Odd Field	Trigger on odd fields
	Even Field	Trigger on even fields
	All Lines	Trigger on all lines
	Line #	Trigger on a specific line
Standard	NTSC	Trigger on NTSC signal
	PAL/SECAM	Trigger on PAL or SECAM signal



The following figures show the video waveforms triggered on odd fields and line 6.

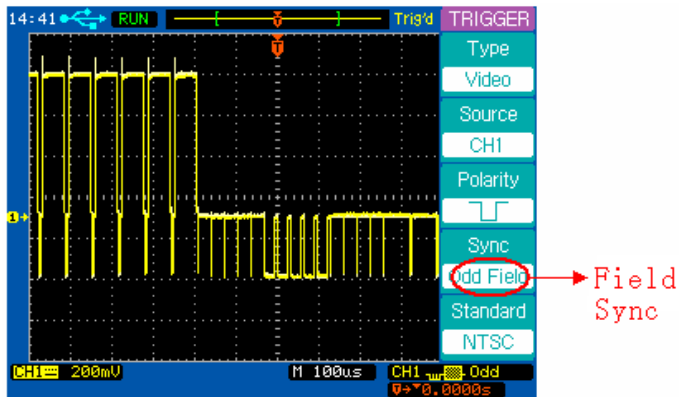

Trigger on odd fields

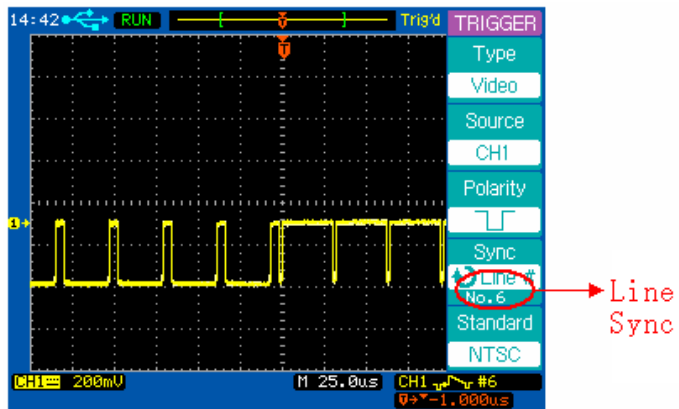



Trigger on specific line 6

Note: The trigger level control is unavailable when Video type is selected.

Edge Trigger

Use edge triggering to trigger on the rising or falling edge of the input signal at the trigger threshold.

Press the trigger control **MENU** key to display the **TRIGGER**

TRIGGER	Softkey	Options	Description
Type	Type	Video	Video triggering
Edge		Edge	Edge triggering
Source		Pulse	Pulse width triggering
CH1	Source	CH1	Trigger on CH1
Slope		CH2	Trigger on CH2
		EXT	Trigger on EXT
Mode		EXT/5	Trigger on EXT/5
Auto		AC Line	Trigger on AC line signal
Coupling		Alternating	Trigger on CH1 and CH2 alternately
DC	Slope		Rising edge of a signal
			Falling edge of a signal
	Mode	Auto	Trigger even without a valid event.
		Normal	Trigger only on a valid event
	Coupling	AC	AC coupling
		DC	DC coupling
		LF Reject	Reject low frequencies
		HF Reject	Reject high frequencies

menu, then press the **Type** softkey to select Edge trigger.

Pulse Width Trigger

Pulse width triggering sets the oscilloscope to trigger on a positive or negative pulse of a specified width from 20ns to 10s.

Basic Operation

Press the trigger control **MENU** key to display the **TRIGGER** menu, then press the **Type** softkey to select Pulse trigger.



Softkey	Options	Description
Type	Video	Video triggering
	Edge	Edge triggering
	Pulse	Pulse width triggering
Source	CH1	Trigger on CH1
	CH2	Trigger on CH2
	EXT	Trigger on EXT
	EXT/5	Trigger on EXT/5
	Alternating	CH1 and CH2 alternately
Pulse Mode		Positive greater than
		Positive equal
		Positive within
		Positive less than
		Negative greater than
		Negative equal
		Negative within
		Negative less than
Pulse Setup		Set the pulse width
More 1/2	----	Select page 2/2

Basic Operation

Press the trigger control **MENU** key to display the **TRIGGER** menu, press the **Type** softkey to select Pulse trigger, and then press the **More 1/2** softkey to display **TRIGGER** menu page 2/2.

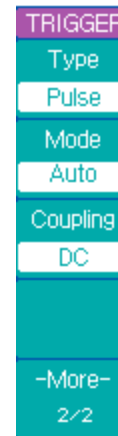

Softkey	Options	Description
Type	Video	Video triggering
	Edge	Edge triggering
	Pulse	Pulse width triggering
Mode	Auto	Trigger even without a valid event.
	Normal	Trigger only on a valid event
Coupling	AC	AC coupling
	DC	DC coupling
	LF Reject	Reject low frequencies
	HF Reject	Reject high frequencies
More 2/2	----	Select page 1/2

ACQUIRE Menu

Press the **ACQUIRE** menu key to show the **ACQUIRE** menu.

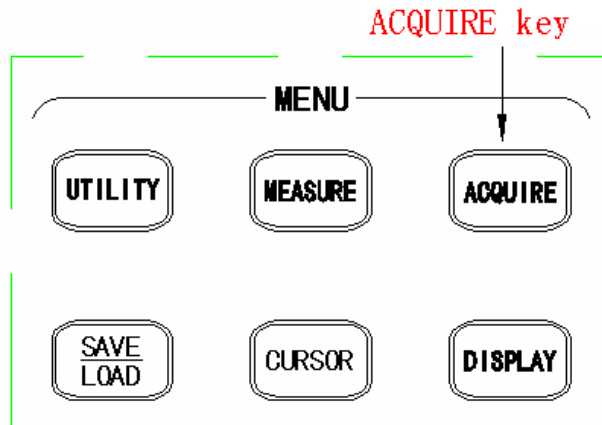

ACQUIRE Menu key

Normal acquisition mode yields the best display for most waveforms.

Average mode lets you average multiple waveforms to reduce noise and increase resolution.

Peak Detect mode should be used to display narrow pulses that occur infrequently. It's useful when looking for very narrow pulses at very slow time base.

Equivalent sampling mode is useful to display high frequency repetitive signals.

Real Time sampling mode is useful to capture single-shot signals.

Press the **Mode** softkey to select the **Normal** mode.

ACQUIRE	Softkey	Options	Description
Mode	Mode	Normal	Normal acquisition.
Normal		Average	Average the waveforms.
		Peak Detect	Peak detect acquisition.
Sampling	Sampling	Equivalent	Equivalent sampling.
Equivalent		Real Time	Real time sampling.
Record	Record	----	Select Record menu.

Basic Operation

Press the **Mode** softkey to select the **Average** mode.

Softkey	Options	Description
Mode	Normal	Normal acquisition.
	Average	Averages the waveforms.
	Peak Detect	Peak detect acquisition.
Averages	↻	Set the average number to 2, 4, 8, 16, 32, 64, 128, or 256.
Sampling	Equivalent	Equivalent sampling.
	Real Time	Real time sampling.
Record	----	Select Record menu.

Press the **Mode** softkey to select the **Peak Detect** mode.

Softkey	Options	Description
Mode	Normal	Normal acquisition.
	Average	Averages the waveforms.
	Peak Detect	Peak detect acquisition.
Sampling	Equivalent	Equivalent sampling.
	Real Time	Real time sampling.

Basic Operation

Record	----	Select Record menu.
---------------	------	---------------------

Connect a sine wave signal to the CH1 channel, press **ACQUIRE** → **Mode** to select Average mode. Turn the Entry knob to set the number of averages to 16. The following two figures show the difference between Normal acquisition and Average acquisition.

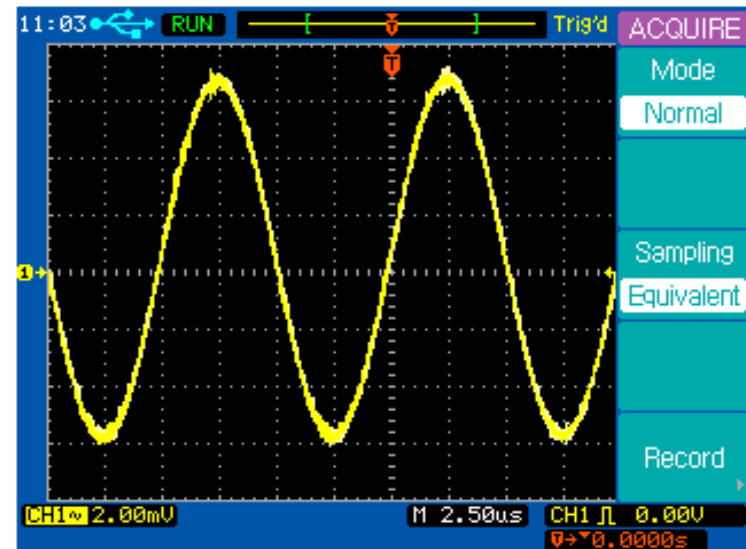

Random noise on the displayed waveform

Basic Operation

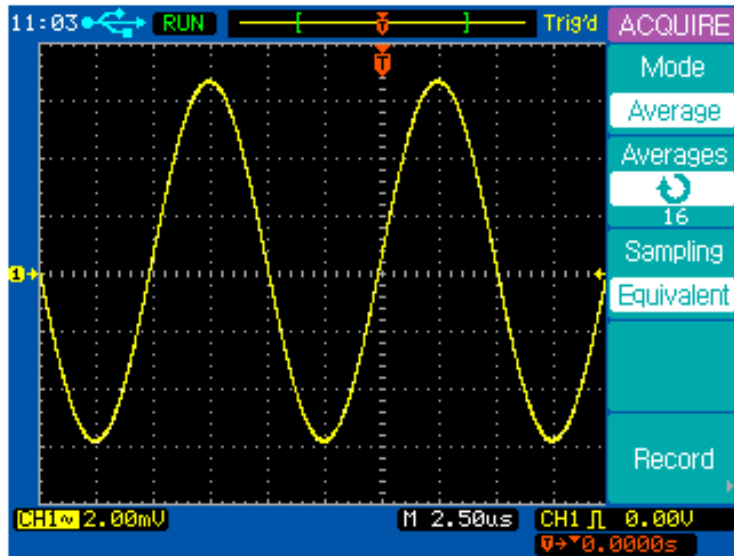

Average count of 16 selected to reduce random noise

Basic Operation





Waveform recorder

The waveform recorder can record input waveforms in a sequence of frames originating from channel 1 or channel 2, with a maximum acquisition depth of 1000 frames of 4k data points each. The time interval between each frame is adjustable from 1ms – 1000s. The waveform recorder lets you monitor and analyze long term signal behavior by recording data continuously over long periods of time then playing it back for post acquisition analysis.

Press **ACQUIRE** → **Record** to show the **RECORD** menu.

Softkey	Options	Description
RECORD Mode	Record	Record waveform.
	Play Back	Play back a recorded waveform.
	Save /Recall	Save/Recall from internal or external memory.
	OFF	Exit Record function.
Source	CH1	Record CH1 channel.
	CH2	Record CH2 channel.
	Pass/Fail Out	Record waveform from Pass/Fail mask test





Basic Operation

Interval		Set the time interval between captured frames. <1ms – 1000s>
End Frame		Set the number of frames you want to record
Operate		Start recording.
		Stop recording

Basic Operation

Play back the record waveform sequence (menu 1 of 2)
 Press **ACQUIRE** → **Record** to show the **RECORD** menu.
 Press the **Mode** softkey to select the Play Back function.

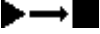

Softkey	Options	Description
Mode	Record	Record the waveform
	Play Back	Play back a recorded waveform.
	Save /Recall	Save/Recall from internal or external memory.
	OFF	Exit Record function
Operate		Start Playback
		Stop Playback
Play Mode		Continuous play mode
		One time play mode
Current Frame		Select a specific frame within the frame sequence and display it on screen
More 1/2	----	Select menu page 2/2

Press the More 1/2 button to show **RECORD** menu page 2

Basic Operation

Play back the record waveform sequence (menu 2 of 2)

Press **ACQUIRE** → **Record** to show the **RECORD** menu.

RECORD	Softkey	Options	Description
Interval 10.0ms	Interval	↻	Set the playback interval between two frames
Start Frame 1	Start Frame	↻	Set the start frame to playback
End Frame 1000	End Frame	↻	Set the end frame to playback
Msg Display ON	Msg Display	ON	Turn recorder message display on
-More- 2/2		OFF	Turn recorder message display off
	More 2/2	----	Select menu page 1/2

Basic Operation

Save/Recall the recorded waveform

Press **ACQUIRE** → **Record** to show the **RECORD** menu.

Press the **Mode** softkey to select the **Save/Recall** function.

RECORD	Softkey	Options	Description
Mode	Mode	Record	Record the waveform.
Save/Recall		Play back	Play back a recorded waveform.
Start Frame 1		Save /Recall	Save/Recall from internal or external memory.
End Frame 200		OFF	Exit Record function
Internal Storage ▶	Start Frame	↻	Set the first frame to be saved.
External Storage ▶	End Frame	↻	Set the last frame to be saved
	Internal Storage	----	Save/Recall from internal memory.
	External Storage	----	Save/Recall from external memory.

Exit the waveform recorder

Press the **Mode** softkey to select the **OFF** option and return to the **ACQUIRE** menu.

RECORD Mode OFF	Softkey	Options	Description
Mode		Record	Record the waveform
		Play back	Play back the record
		Save /Recall	Save/Recall from internal or external memory
		OFF	Exit Record function
↶	↶	----	Return to ACQUIRE menu

UTILITY Menu

Press the **UTILITY** menu key to show the **UTILITY** menu.

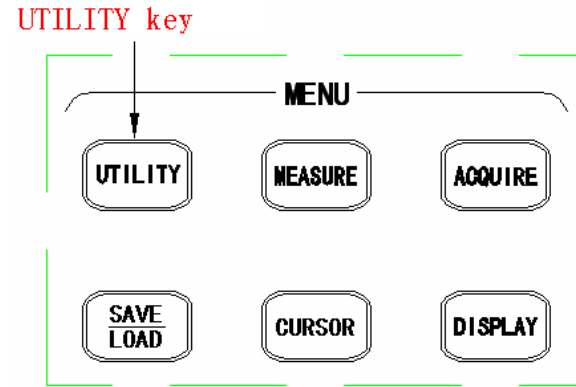

UTILITY Menu key

Basic Operation

Press the **UTILITY** key to display the **UTILITY** menu page 1/2.

UTILITY	Softkey	Options	Description
I/O Setup	I/O Setup	----	Select I/O SETUP menu
Print Setup	Print Setup	----	Select PRINT menu
System Setup	System Setup	----	Select SYSTEM menu
Language English	Language	English	default
-More- 1/2			
	More 1/2	----	Select menu page 2/2



Press the **More 1/2** softkey to display the **UTILITY** menu page 2/2.

UTILITY	Softkey	Options	Description
Service	Service	----	Select Service menu
Pass/Fail	Pass/Fail	----	Select PASS/FAIL menu
Self-Cal	Self-Cal	RUN/STOP	Start self-calibration
		AUTO	Exit self-calibration
	More 2/2	----	Select menu page 1/2
-More- 2/2			

Basic Operation

I/O Setup

Press **UTILITY** → **I/O Setup** to display the **I/O SETUP** menu.

I/O SETUP	Softkey	Options	Description
Type	Type	USB Slave	Select USB
USB Slave		RS232C	Select RS232C
		GPIB	Select GPIB
		----	Return to the UTILITY menu
			

Note: An optional expansion module is required to remotely control the instrument via RS232 and GPIB interface. Contact B&K Precision Corp. for details and availability.

Print Setup

Press **UTILITY** → **Print Setup** to display the **PRINT** menu.

Press the **Print to** softkey to select File.

PRINT	Softkey	Options	Description
Print to File	Print to	File	Print to file
File Type BMP	File Type	BMP	BMP file format
		CSV	CSV file format
		---	Return to the UTILITY menu









Connect a USB mass storage device to the USB host connector on the front or rear panel.

Press the **File Type** softkey to select the file format you want. BMP is a bitmap of the screen and CSV are comma-separated values. CSV format can be imported into spreadsheets such as Excel.

Press the **PRINT** key to save the file to the USB mass storage device.

System Setup

Press **UTILITY** → **System Setup** to display the **SYSTEM** menu.

SYSTEM	Softkey	Options	Description
Key Sound 	Key Sound		Key press sound on
			Key press sound off
Alarm Sound 	Alarm Sound		Alarm sound on
			Alarm sound off
Counter OFF	Counter	ON	Frequency counter on
		OFF	Frequency counter off
Set Date & Time 	Set Date & Time	---	Select the DATE&TIME menu
		---	Return to the UTILITY menu

Note: With Alarm set to “On”, you will hear a beep under the following conditions: A control reached its limit or an invalid setting or configuration was encountered, in which case you will also see a warning message displayed on screen (example: Auto button is pressed without detecting a signal).

Basic Operation

Press the **Set Date&Time** softkey to display the **DATE&TIME** menu.

DATE&TIME	Softkey	Options	Description
Display ON	Display	ON	Date & time display on
		OFF	Date & time display off
Hour Min 9 42	Hour	↻	Set hour
Month Day 4 28	Min	↻	Set minute
Year 2007	Month	↻	Set month
	Day	↻	Set day
	Year	↻	Set year
OK! Enter	OK! Enter	----	Apply the time and date

Basic Operation

Service

Press **UTILITY** → **Service** to display the **Service** menu.

SERVICE	Softkey	Options	Description
System Info	System Information	----	Display system information: Model, Serial number, Software version, Installed modules.
Screen Test			
Key Test	Screen Test	----	Test the LCD screen.
	Key Test	----	Check keys and controls operation.
	↻	----	Return to the UTILITY menu.

Basic Operation

Press **UTILITY** → **Service** to display the **Service** menu, then press the **System Info** softkey to display the system information, such as Model, Serial number, Power up times, Software version and a list of installed modules.

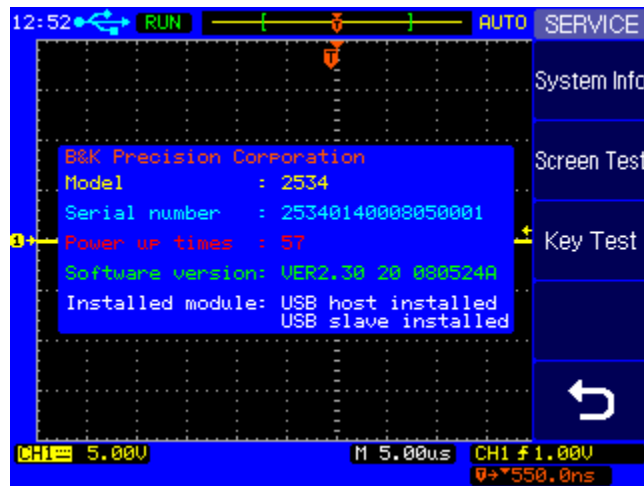

System Information

Basic Operation

Pass/Fail Mask test

The Mask Test function monitors waveform changes by. If the input signal is within the mask threshold, a PASS verdict will be generated. If the input signal lies outside the threshold, a FAIL verdict will be generated.

For step by step setup instructions, refer to the Application examples in chapter 3, section Pass/Fail measurement.

Press **UTILITY** → **Pass/Fail** to display the **PASS/FAIL** menu 1/2.

Softkey	Options	Description
Enable Test	ON	Turn mask function on
	OFF	Turn mask function off
Source	CH1	Source signal is CH1
	CH2	Source signal is CH2
Operate	▶	Start Pass/Fail test
	■	Stop Pass/Fail test
Setup Mask	----	Set up the specifications
More 1/2	----	Display the menu 2/2

Basic Operation

Press **More 1/2** to display the **PASS/FAIL** menu 2/2.

PASS/FAIL	Softkey	Options	Description
Msg Display ON	Msg Display	ON	Display P/F information
		OFF	Turn Display P/F information off
Output Fail+OK Stop on Output OFF	Output	PASS	Indicate Pass condition
		PASS+OK	Output to screen and sound alarm on Pass condition
		FAIL	Indicate Fail condition
		FAIL+OK	Output to screen and sound alarm on Fail condition
-More- 2/2	Stop on Output	ON	Stop sampling on output
		OFF	Continue sampling on output
		----	Return to the UTILITY menu
	More 2/2	----	Display the menu page 1/2

Note:The Pass/Fail function is not available when X-Y mode is selected.

Basic Operation

Press **UTILITY** → **Pass/Fail** → **Setup Mask** to display the **MASK** menu 1/2.

MASK	Softkey	Options	Description
X Mask 0.40div	X Mask		Set the mask's horizontal failure margin
			Set the mask's vertical failure margin
Y Mask 0.40div	Y Mask		Set the mask's vertical failure margin
			Set the mask's horizontal failure margin
Create Mask	Create Mask	----	Create the P/F mask based on the current waveform and the above failure margins
		----	Return to the PASS/FAIL menu
-More- 1/2	More 1/2	----	Display the menu 2/2

Press **More 1/2** to display the **MASK** menu 2/2.

MASK	Softkey	Options	Description
Internal Storage	Internal Storage	----	Store the PASS/FAIL tolerance mask to internal memory.
External Storage	External Storage	----	Store the PASS/FAIL tolerance mask to external USB mass storage device.
↶	↶	----	Return to the PASS/FAIL menu.
-More- 2/2	More 2/2	----	Display the menu page 1/2.

Self-Calibration

To maximize the measurement accuracy, it is recommended to perform a self-calibration.

Self-calibration uses internally-generated signals to calibrate circuits that affect channel scale, offset, and trigger parameters. Disconnect all inputs and allow the oscilloscope to warm up for at least 30 minutes before performing a self-calibration.

Press **UTILITY** → **Self-Cal** to display the self-calibration page. Press the **AUTO** key to exit the self-calibration page. Press the **RUN** key to start the self-calibration.

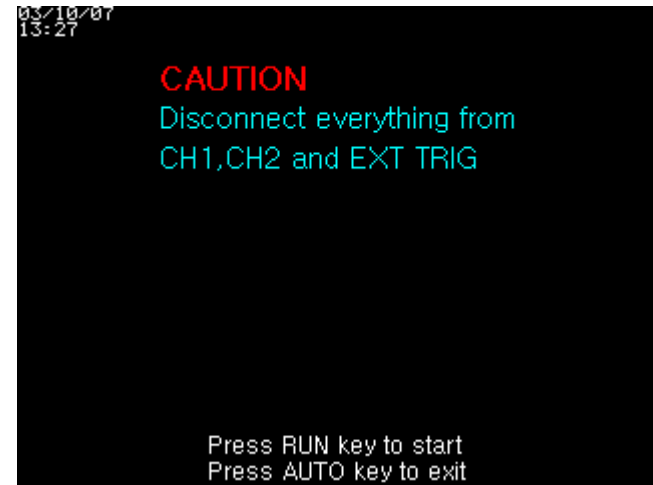

Self Calibration

Note: Warm up the oscilloscope for at least 30 minutes before performing self-calibration.

MEASURE Menu

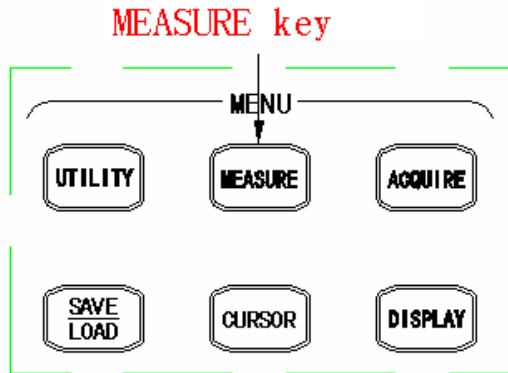

MEASURE Menu key

Press the **MEASURE** key to display the **MEASURE** menu.



Softkey	Options	Description
Source	CH1	Measure CH1
	CH2	Measure CH2
Voltage	----	Select the Voltage measurement menu.
Time	----	Select the Time measurement menu.
Clear	----	Turn off the measurement readouts.
Measure All	ON	Display all measurements.
	OFF	Turn off all measurements.

Voltage Measurements

Press **MEASURE** → **Voltage** to display the **VOLTAGE** menu page 1/4.



Softkey	Options	Description
Peak-Peak	----	The Peak-Peak value is the difference between maximum and minimum values.
Amplitude	----	The Amplitude value is the difference between its High and Low values.
Max	----	Max is the maximum voltage in the waveform display.
Min	----	Min is the minimum voltage in the waveform display
More 1/4	----	Display menu page 2/4





Press the **More 1/4** softkey to display the **VOLTAGE** menu page 2/4.



Softkey	Options	Description
High	----	Measures the flattop voltage (average value) of the upper part of the waveform.
Low	----	Measures the flat base voltage (average value) of the upper part of the waveform.
Average	----	Average value is the sum of the samples divided by the number of samples over the entire waveform.
RMS	----	RMS value is the true Root Mean Square voltage over the entire waveform.
More 2/4	----	Display menu page 3/4.



Basic Operation

Press the **More 2/4** softkey to display the **VOLTAGE** menu page 3/4.

VOLTAGE	Softkey	Options	Description
 Cycle Avg	Cycle Avg	----	The Cycle Avg value is the sum of the samples divided by the number of samples over one period.
 Cycle RMS	Cycle RMS	----	The Cycle RMS value is the true Root Mean Square voltage over one period.
 Overshoot	Overshoot	----	The Overshoot value is the distortion that follows a major edge transition expressed as a percentage of amplitude.
 Preshoot	Preshoot	----	The Preshoot value is the distortion that precedes a major edge transition expressed as a percentage of amplitude.
 -More- 3/4	More 3/4	----	Display menu page 4/4.

Basic Operation

Press the **More 3/4** softkey to display the **VOLTAGE** menu page 4/4.

VOLTAGE	Softkey	Options	Description
 ↶	↶	----	Return to the MEASURE menu
 -More- 4/4	More 4/4	----	Display menu page 1/4

Time Measurements

Press **MEASURE** → **Time** to display the **TIME** menu page 1/5.



TIME	Softkey	Options	Description
Frequency	Frequency	----	Frequency is defined as 1/period of the first cycle.
Period	Period	----	Period is the time period of the first complete waveform cycle.
Rise Time	Rise Time	----	Rise Time is the time that the first positive-going edge takes to rise from 10% to 90% of its amplitude.
Fall Time	Fall Time	----	Fall Time is the time that the first negative-going edge takes to fall from 90% to 10% of its amplitude.
-More- 1/5	More 1/5	----	Display menu page 2/5.

Press **More 1/5** softkey to display the **TIME** menu page 2/5.

TIME	Softkey	Options	Description
+ Width	+Width	----	+Width is the time between the 50% amplitude points of the first positive pulse.
- Width	-Width	----	-Width is the time between the 50% amplitude points of the first negative pulse.
+ Duty	+Duty	----	+Duty is the ratio of the first positive width to its period, expressed as a percentage.
- Duty	-Duty	----	-Duty is the ratio of the first negative width to its period, expressed as a percentage.
-More- 2/5	More 2/5	----	Display menu page 3/5.

Basic Operation

Press the **More 2/5** softkey to display the **TIME** menu page 3/5.





TIME	Softkey	Options	Description
 Delay1f+2f	Delay 1f+2f	----	Measures the delay between 2 waveforms using the first rising edge of each channel as reference.
 Delay1f+2f	Delay 1f+2f	----	Measures the delay between 2 waveforms using the first falling edge of each channel as reference.
 Delay1f+2f	Delay 1f+2f	----	Measures the delay between 2 waveforms using the time between the first rising edge of CH1 and the first falling edge of CH2 (50% amplitude point).
-More- 3/5			

Basic Operation

Delay 1f+2f	----	Measures the delay between 2 waveforms using the time between the first falling edge of CH1 and the first rising edge of CH2.
More 3/5	----	Display menu page 4/5.

Basic Operation

Press the **More 3/5** softkey to display the **TIME** menu page 4/5.

TIME	Softkey	Options	Description
 Phase 1→2  Phase 2→1  X at Max  X at Min -More- 4/5	Phase 1→2	----	Phase 1→2 is the time in degrees between corresponding points from waveforms 1 to waveform 2. [See note]
	Phase 2→1	----	Phase 2→1 is the time in degrees between corresponding points from waveforms 1 to waveform 2. [See note]
	X at Max	----	X at Max is the X axis value (i.e., time) referred to the trigger point at the first displayed occurrence of the waveform Maximum, starting from the left side of the display to the following waveform maximum.

Basic Operation

X at Min	----	X at Min is the X axis value (i.e., time) referred to the trigger point at the first displayed occurrence of the waveform Minimum, starting from the left side of the display, to the following waveforms minimum
More 4/5	----	Display menu page 5/5

Note: time in degrees between the two points is calculated by measuring the time between the two points, dividing the time by the waveform's period, then multiplying the fraction by 360 degrees.

Press the **More 4/5** softkey to display the **TIME** menu page 5/5.

TIME	Softkey	Options	Description
		----	Return to the MEASURE menu
	More 5/5	----	Display menu page 1/5

Automatic Measurement Procedure

Press **MEASURE** → **Measure All** to turn on Auto Measurements. Up to 20 measurements of the current channel are displayed at the center of the screen.

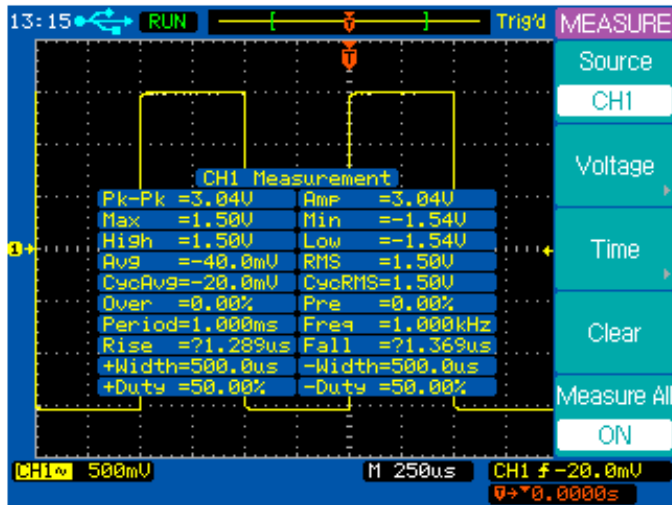

Press the **Measure All** softkey again to turn off Auto Measurements.

Press **MEASURE** → **Voltage** to display the **VOLTAGE** menu or press **MEASURE** → **Time** to display the **TIME** menu.

Press the softkey of the voltage or time parameters you want to measure.

The selected parameter will be displayed on the bottom of the display.

Press the **Clear** softkey to clear all displayed measurement parameter.

Note: Up to three parameters can be displayed at the same time on the bottom of the display. When three parameters are already displayed, the first parameter will be pushed out of the display window when a new parameter is chosen for display.

Note: "****" will be displayed when a parameter cannot be measured correctly.

Measurement definitions

The following figure shows the voltage measurement points.

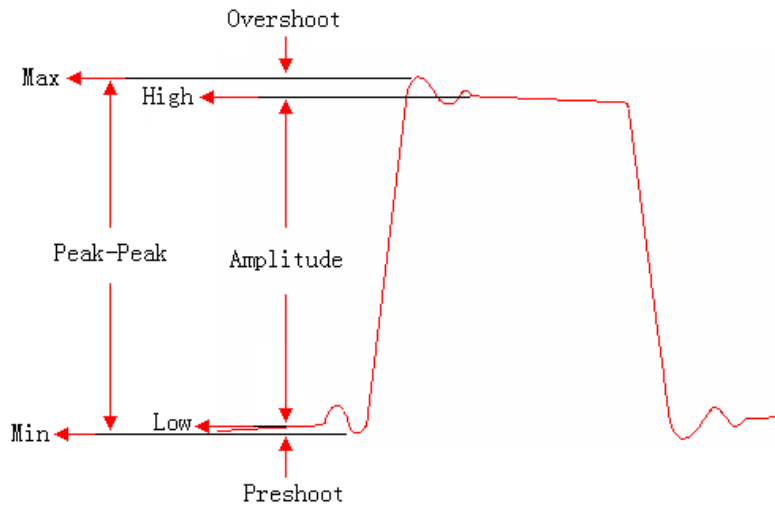

The following figure shows the time measurement points.

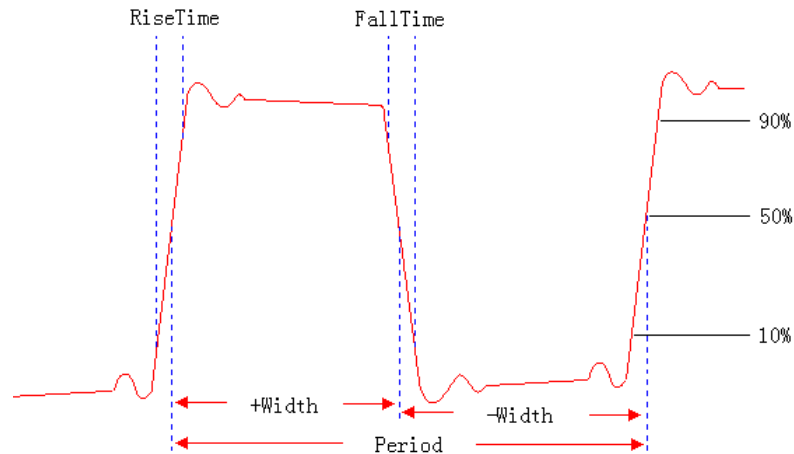

SAVE/LOAD Menu

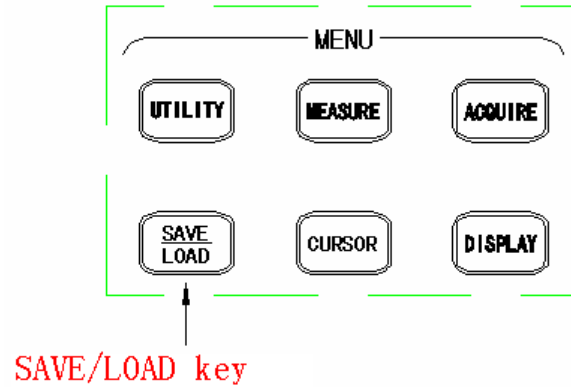

SAVE/LOAD MENU key

Press the **SAVE/LOAD** key to display the **SAVE/LOAD** menu.

SAVE/LOAD	Softkey	Options	Description
Internal Storage	Internal Storage	----	Display the INTERNAL menu.
External Storage	External Storage	----	Display the EXTERNAL menu.
Factory	Factory	----	Set the instrument to the factory default configuration.

Basic Operation

Internal Storage

Press **SAVE/LOAD** → **Internal Storage** → **Storage type** to display the **INTERNAL** menu and select Waveforms storage type.

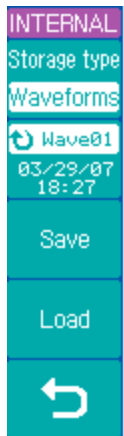

Softkey	Options	Description
Storage type	Waveforms	Waveform file format
	Setups	Setup file format
Wavexx mm/dd/yy hh/mm	↻	Select a waveform file from Wave01 to Wave10. Date and time of the current file are displayed.
Save	----	Save the display to the current waveform file.
Load	----	Load the current waveform file.
↻	----	Return to the SAVE/LOAD menu.

Basic Operation

Press **SAVE/LOAD** → **Internal Storage** → **Storage type** to display the **INTERNAL** menu and select Setups storage type.



Softkey	Options	Description
Storage type	Waveforms	Waveform file format
	Setups	Setup file format
Setupxx mm/dd/yy hh/mm	↻	Select a setup file from Setup01 to Setup10. The date and time of the current file are displayed.
Save	----	Save the current configuration to the selected setup file.
Load	----	Load from the selected setup file.
↻	----	Return to the SAVE/LOAD menu.

External Storage

Press **SAVE/LOAD** → **External Storage** to display the **EXTERNAL** menu.

EXTERNAL	Softkey	Options	Description
New	New	----	Create a new file or folder in the external memory.
Rename	Rename	----	Rename the current file or folder.
Load	Load	----	Load the current file.
Delete	Delete	----	Delete the current file or folder.
↶	↶	----	Return to the SAVE/LOAD menu

Note: The above External Storage menu is only available if a USB flashdrive is connected to the front panel USB host port.

Press **SAVE/LOAD** → **External Storage** → **New** to display the **New** menu.

New	Softkey	Options	Description
New File	New File	----	Display the New File menu.
New Folder	New Folder	----	Display the New Folder menu.
↶	↶	----	Return to the EXTERNAL menu

Basic Operation

Press **SAVE/LOAD** → **External Storage** → **New** → **New File** to display the **New File** menu.

New File	Softkey	Options	Description
Save as	Save as	Setups	Save as setup files
Setups		Waveforms	Save as waveform files
Enter Character		BMP	Save as BMP files
Delete Character		CSV	Save as CSV files
Save	Enter Character	----	Enter the selected character and go to the next character position.
	Delete Character	----	Delete the selected character.
	Save	----	Save the new file.
	↶	----	Return to the New menu.

Note: The maximum length of a file name is 8 characters.

Press **Enter Character** to select a character position in the file name. Turn the entry knob to select a character. Press **Delete Character** to delete the selected character. Press **Enter Character** to enter the selected character and go to the next character position.



Basic Operation

Press **SAVE/LOAD** → **External Storage** → **New** → **New Folder** to display the **New Folder** menu.

New Folder	Softkey	Options	Description
Enter Character	Enter Character	----	Enter the selected character and go to the next character position.
Delete Character	Delete Character	----	Delete the selected character.
Save	Save	----	Save the new folder.
↶	↶	----	Return to the New menu.



Basic Operation

Press **SAVE/LOAD** → **External Storage** → **Rename** to display the **Rename** menu.

Rename	Softkey	Options	Description
Enter Character	Enter Character	----	Enter the selected character and go to the next character position.
Delete Character	Delete Character	----	Delete the selected character.
OK	OK	----	Rename the selected file or folder.
		----	Return to the EXTERNAL menu.

Basic Operation

Press **SAVE/LOAD** → **External Storage** → **Delete** to display the **Delete** menu.

Delete	Softkey	Options	Description
OK	OK	----	Confirm the deletion of the selected file or folder.
Cancel	Cancel	----	Cancel the deletion operation.
		----	Return to the EXTERNAL menu.

Firmware Update

The oscilloscope firmware can be conveniently updated via the front panel USB host interface.

Press **SAVE/LOAD** → **External Storage** to display the **EXTERNAL** menu.

Turn the entry knob to select the correct update file. The file 2042A.UPT is selected as shown in the following figure.

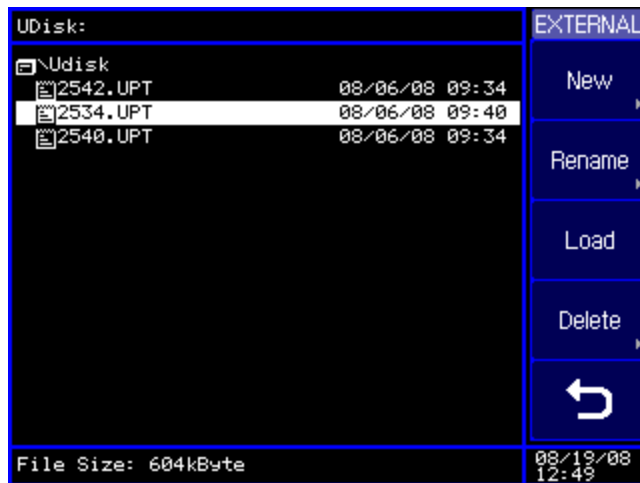

Press the **Load** softkey to start the update operation. A loading progress bar and then an updating progress bar will be displayed and indicate the progress of the update operation.

Finally, the message “**Restart to complete updating**” will be displayed to remind you to restart (power cycle) the instrument.

If the software update failed, repeat the above procedures to update again.

Note: The default file extension of the update file is “.upt”.

Select the correct update file according to the model of the oscilloscope. The error message “Incompatible file ” will be displayed if the file is not the correct one for your oscilloscope.

Note: Power to the oscilloscope must not be turned off during the updating process. If this happens, you will have to return the instrument to the factory for service.

CURSOR Menu

You can measure waveform parameters using the cursors. Cursors are horizontal and vertical markers that indicate X-axis values (usually time) and Y-axis (usually voltage) on a selected waveform. The position of the cursors can be moved by turning the Entry knob.

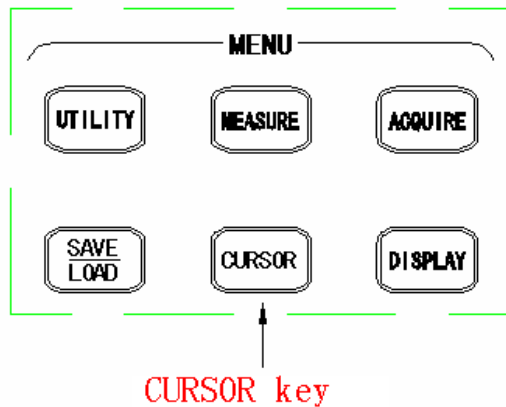

Cursor Menu key

The oscilloscope provides three kinds of cursor measurement modes: **Manual**, **Auto** and **Track**.

Manual Cursor Mode

In manual cursor mode, you can move the cursors to measure the voltage or time on the selected waveform.

Press **CURSOR** → **Mode** to display the **CURSOR** menu and select the **Manual** mode. Press the **Type** softkey to select **Voltage** measurement.

Softkey	Options	Description
Mode	Manual	Manual cursor measurement
	Auto	Auto cursor measurement
	Track	Track cursor measurement
Source	CH1	Measure CH1
	CH2	Measure CH1
	MATH	Measure MATH
Type	Voltage	Measure voltage value
	Time	Measure time value
Y1-- Y2--		Press this softkey to active Y1, Y2, or both Y1 and Y2 cursors for adjustment. Current voltage values for Y1 and Y2 are displayed in the softkey
ΔY	----	The difference value between the Y1 and Y2 cursor voltage values.

Press **CURSOR** → **Mode** to display the **CURSOR** menu and select the **Manual** mode. Press the **Type** softkey to select **Time** measurement.

CURSOR	Softkey	Options	Description
Mode	Mode	Manual	Manual cursor measurement
Manual		Auto	Auto cursor measurement
Source		Track	Track cursor measurement
CH1	Source	CH1	Measure CH1
Type		CH2	Measure CH1
Time		MATH	Measure MATH
t) X1 -- -2.000ns t) X2 -- 28.40ns	Type	Voltage	Measure voltage value
ΔX 30.40ns 1/ ΔX 32.89MHz		Time	Measure time value
X1-- X2--			Press this softkey to select X1, X2, or both X1 and X2 cursors for adjustment. Current time values for X1 and X2 are displayed in the softkey
ΔX 1/ ΔX		----	ΔX is the time difference value between the X1 and X2 cursors. 1/ ΔX is the frequency "between" the X1 and X2 cursors.

Track Cursor Mode

In the track mode, the screen displays two cross hair cursors. The cross hair of the cursor is positioned on the waveform automatically. You can adjust the selected cursor's horizontal position on the waveform by turning the entry knob.

The oscilloscope displays the values of the coordinates on the screen, either in the softkey area or on the top right corner in case the menu is off.

Press **CURSOR** → **Mode** to display the **CURSOR** menu and select the **Track** mode.

CURSOR	Softkey	Options	Description
Mode	Mode	Manual	Manual cursor measurement
Track		Auto	Auto cursor measurement
Cousor A CH1		Track	Track cursor measurement
Cousor B None	Cursor A	CH1	Track CH1 with Cursor A
Ax -- -8.000us Ay -- 0.00V		CH2	Track CH2 with Cursor A
None		None	Turn off Cursor A
Bx -- ***** By -- *****	Cursor B	CH1	Track CH1 with Cursor B
None		CH2	Track CH2 with Cursor B
None		None	Turn off Cursor B
↻Ax-- Ay--	↻		Press this softkey to select cursor A for adjustment. The current X, Y axis values for the tracking point of cursor A are displayed in the softkey.
↻Bx-- By--	↻		Press this softkey to select cursor B for adjustment. The current X, Y axis values for the tracking point of Cursor B are displayed in the softkey.

Auto Cursor Mode

The Auto mode cursors are displayed only when the auto measurement function is enabled. The oscilloscope displays the auto cursors corresponding to the latest auto measurement parameter. The Auto cursors will not be displayed when no auto measurement parameter is selected.

DISPLAY Menu

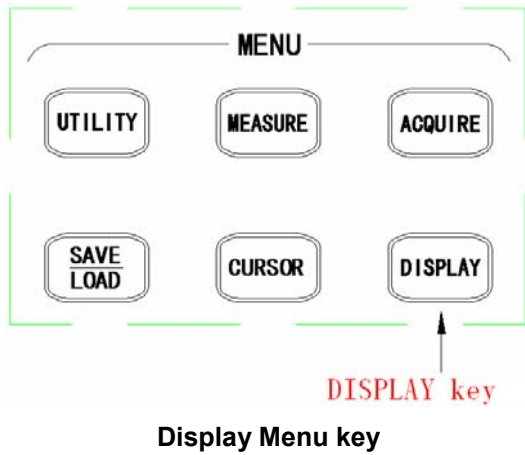

Press the **DISPLAY** menu key to display the **DISPLAY** menu page 1/2.



Softkey	Options	Description
Type	Vector	Vector mode draws a line between adjacent sample points in the waveform.
	Dots	Dot mode displays only the sample points.
Grid		Display both grids and axes.
		Turn off the axes.
		Turn off the grids.
		Turn off both grids and axes.
Contrast		Adjust the display contrast and brightness.
Color Setup	----	Select the color scheme.
More 1/2	----	Display menu page 2/2.

Press **More 1/2** softkey to display the **DISPLAY** menu page 2/2.

DISPLAY	Softkey	Options	Description
Persist OFF	Persist	ON	The scope updates the waveform without erasing the previously-displayed waveforms.
Clear Persistence Normal		OFF	Turn off the persistence function
-More- 2/2	Clear Persistence	----	Press the softkey to erase the previous sample points.
Waveforms	Waveforms	Normal	Select the color display.
		Monochrome	Select the monochrome display.
	More 2/2	----	Display menu page 1/2.

RUN Controls

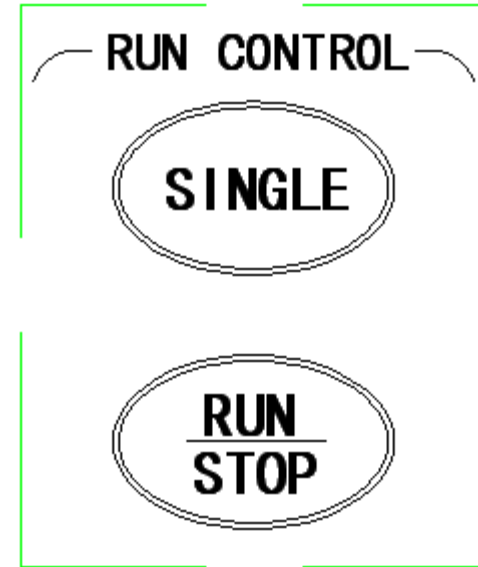

Run controls

Press the **SINGLE** key to execute a single-shot acquisition. The key will illuminate in orange until the oscilloscope is triggered. When the oscilloscope is triggered, the waveform will be acquired and displayed, after which the oscilloscope will ignore any further triggers.

The **RUN/STOP** key is used to manually start/stop the oscilloscope's acquisition system. In run mode, the oscilloscope will start looking for a trigger and the

Basic Operation

RUN/STOP key be green. When the trigger mode is set to Normal mode, the display will not update until a trigger is found. If the trigger mode is set to Auto mode, the oscilloscope looks for a trigger, and if no trigger is found, it will be triggered automatically and the input signal(s) will be displayed immediately.

Press the **RUN/STOP** key again to stop acquiring data. The **RUN/STOP** key will be a red color. Now you can pan across and zoom in on the acquired waveform.

Basic Operation

3. Application Examples

This section presents 7 typical application examples. These examples highlight the features of the oscilloscope and give you ideas on how to solve your own test problems.

Make Simple Measurements

You need to measure the amplitude and frequency of an unknown signal on CH1.

Perform following steps to quickly display the signal.

- Connect the channel 1 probe to the unknown signal.
- Press the **AUTO** key.

The oscilloscope automatically sets the vertical, horizontal, and trigger controls. You can adjust any of these controls manually if you need to optimize the display of the waveform.

When you are using both CH1 and CH2 channels, the Autoset function sets the vertical controls for each channel and uses the CH1 channel to set the horizontal and trigger controls.

The oscilloscope can automatically display most signals. Perform following steps to measure signal amplitude and frequency.

- Press the **MEASURE** key to display the **MEASURE** menu.
- Press the **Voltage** softkey to display the **VOLTAGE** menu.
- Press the **Amplitude** softkey to measure the amplitude. The amplitude value will be displayed at the bottom of the screen.
- Press the **MEASURE** key again to display the **MEASURE** menu.
- Press the **Time** softkey to display the **TIME** menu.
- Press the **Frequency** softkey to measure the frequency. The frequency value will be displayed at the bottom of the screen to the right of the voltage value.

Capture a Single-Shot Signal

A digital storage oscilloscope can easily capture an unrepeatable signal:

- Connect the channel 1 probe to the unknown signal.
- Press the trigger **MENU** key to display the **TRIGGER** menu.
- Press the **Source** softkey to select CH1.
- Press the **Mode** softkey to select the Auto trigger mode.
- Set the vertical and horizontal controls to what you expect to be appropriate for the signal.
- Press the **Type** softkey from the **TRIGGER** menu page 1/2 to select the pulse trigger type.
- Press the **More 1/2** softkey to display the **TRIGGER** menu page 2/2.
- Press the **Mode** softkey to select the normal trigger mode.
- Press the **More 2/2** softkey to display the **TRIGGER** menu page 1/2.
- Press the **Pulse Mode** softkey to select  (positive less than).
- Rotate the entry knob (↻) to set up the pulse width.
- Press the **SINGLE** key to start the search for the trigger event. The **SINGLE** key is illuminated in orange

- When trigger condition is met, the captured waveform is displayed, the **SINGLE** key is not lit, and the **RUN/STOP** key is illuminated in red.

Reduce the Random Noise on a Signal

If the test signal is noisy, you can set up the oscilloscope to reduce the noise on the displayed waveform. First, you stabilize the displayed waveform by removing the noise from the trigger path. Second, you reduce the noise on the displayed waveform.

- Connect a signal to the oscilloscope. Press the **AUTO** key to display the signal.

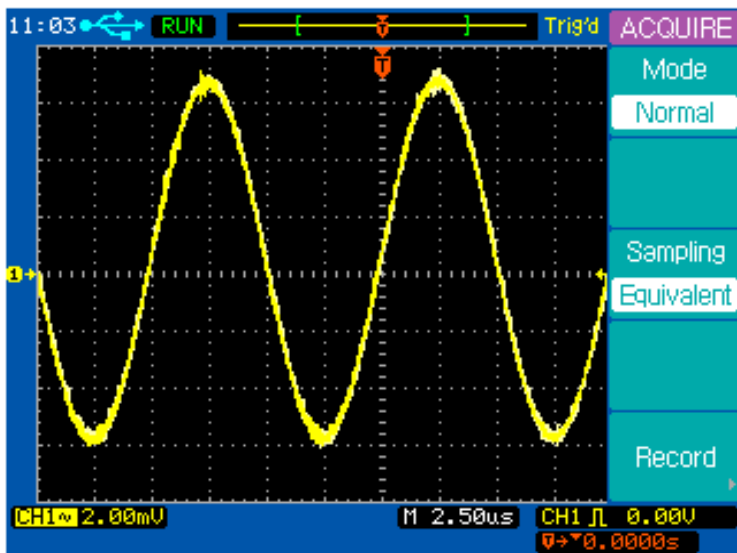

- Press the Trigger **MENU** key to display the **TRIGGER** menu.
- Press the **Type** softkey to select **Edge** trigger type.
- Press the **Coupling** to select **HF Reject** or **LF Reject** coupling mode to reduce the noise from the trigger channel.
- Press the **ACQUIRE** key to display the **ACQUIRE** menu.
- Press the **Mode** softkey to select **Average** mode.
- Rotate the entry knob (↻) to set the number of averages that best eliminates the noise from the displayed waveform.

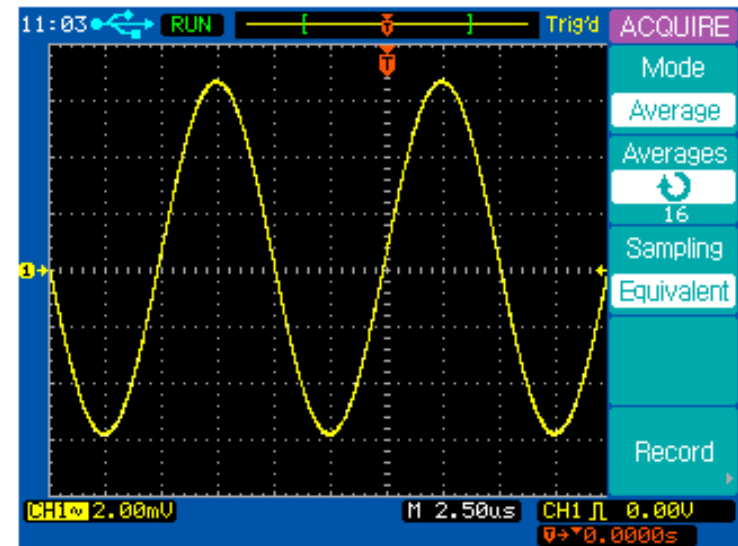

Trigger on a Video Signal

The video trigger can be used to capture standard video signals. The trigger circuit detects the vertical and horizontal intervals of the waveform and produces triggers based on the video trigger settings you have selected.

Trigger on Odd or Even Fields of the Video Signal

- Press the Trigger **MENU** key to display the **TRIGGER** menu.
- Press the **Type** softkey to select the **Video** trigger mode.
- Press the **Source** softkey to select **CH1** (this assumes the signal is on channel 1).
- Press the **Polarity** softkey to select negative polarity \lrcorner .
- Press the **Sync** softkey to select **Odd Field** or **Even Field**.

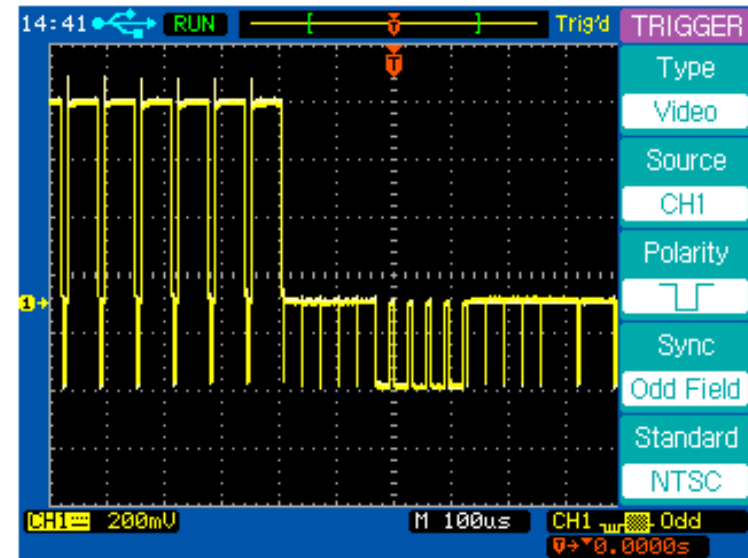

Trigger on a Specific Line or All Lines of the Video Signal

- Press the Trigger **MENU** key to display the **TRIGGER** menu.
- Press the **Type** softkey to select the **Video** trigger mode.
- Press the **Source** softkey to select **CH1**.
- Press the **Polarity** softkey to select negative polarity \lrcorner .
- Press the **Sync** softkey to select **Line #** or **All Lines**.

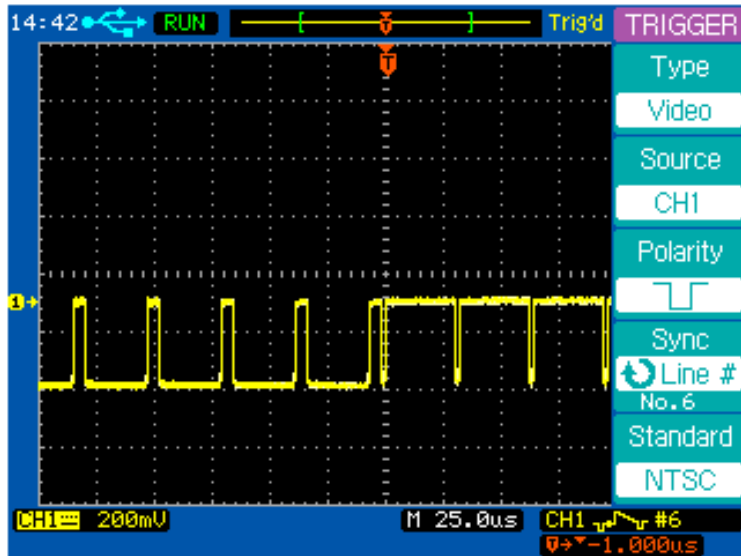

PASS/FAIL Measurement

The oscilloscope measures and compares the input signal with a predefined Pass/Fail mask. If the input signal is within the mask threshold, a PASS verdict will be generated. If the input signal lies outside the threshold, a FAIL verdict will be generated.

Perform the following steps to make a PASS/FAIL measurement.

- Press the **UTILITY** key to display the **UTILITY** menu page 1/2.
- Press the **More 1/2** softkey to display the **UTILITY** menu page 2/2.
- Press the **Pass/Fail** softkey to display the **PASS/FAIL** menu.
- Press the **Enable Test** softkey to turn on the **PASS/FAIL** measurement.
- Press the **Setup Mask** softkey to display the **MASK** menu.
- Press the **X Mask** softkey and then rotate the entry knob to setup the horizontal threshold.
- Press the **Y Mask** softkey and then rotate the entry knob to setup the vertical threshold.
- Press the **Create Mask** softkey to update the thresholds.
- Press the **Return** softkey to return to the **PASS/FAIL** menu.

Application Examples

- Press the **More 1/2** softkey to display the **PASS/FAIL** menu page 2/2.
- Press the **Msg Display** softkey to display the Pass/Fail measurement results on the top left corner of the screen.
- Press the **Output** softkey to set how the results will be indicated.
- Press the **More 2/2** to display the **PASS/FAIL** menu page 1/2.
- Press the **Operate** softkey to start the PASS/FAIL measurement.

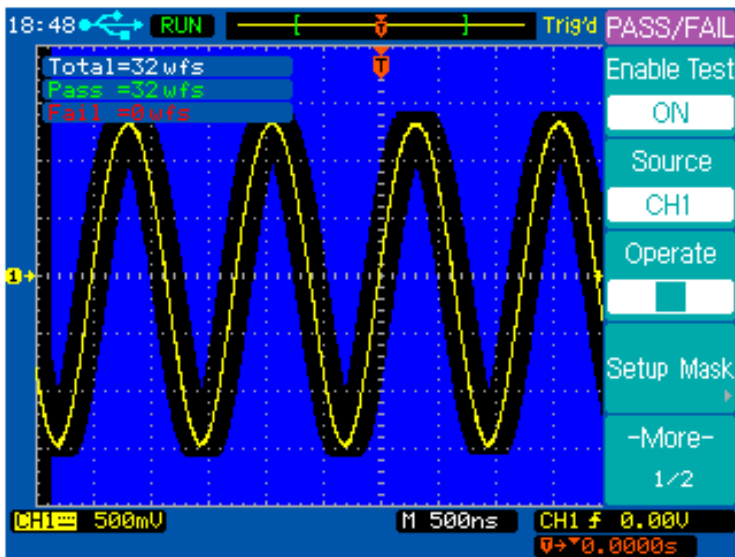

Application Examples

Waveform Recorder

The waveform recorder lets you monitor and analyze long term signal behavior by recording data continuously over long periods of time then playing it back for post acquisition analysis. Data is recorded in a sequence of up to 1000 frames of 4k data points each and the time interval between each frame is adjustable from 1ms – 1000s.



Perform the following steps to record waveforms.

- Press the **ACQUIRE** key to display the **ACQUIRE** menu.
- Press the **RECORD** softkey to display the **RECORD** menu.
- Press the **Mode** softkey to select **Record** mode.
- Press the **Source** softkey to select the source channel **CH1**.
- Press the **Operate** key to start recording. The total recorded frame count is displayed on the top left screen.

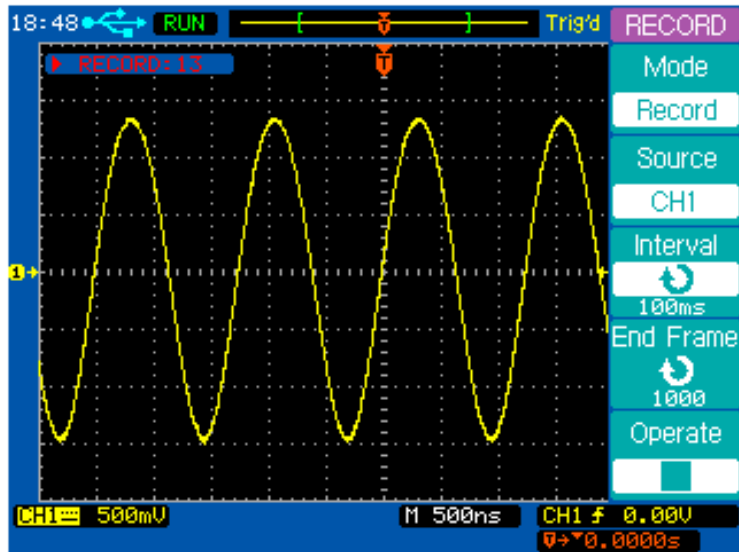
Application Examples



Perform the following steps to playback the waveforms.

- Press the **ACQUIRE** key to display the **ACQUIRE** menu.
- Press the **RECORD** softkey to display the **RECORD** menu.
- Press the **Mode** softkey to select **Play back** mode.
- Press the **Play Mode** softkey to select  or  mode.
- Press the **Start Frame** softkey and turn the entry knob to set the start frame.
- Press the **End Frame** softkey and turn the entry knob to set the end frame.
- Press the **Interval** softkey and turn the entry knob to set the interval time.

Application Examples

- Press the **Operate** softkey to playback the waveform.

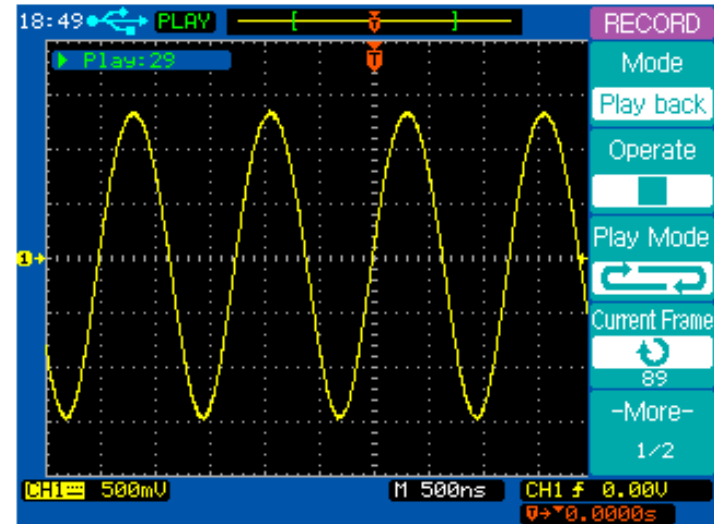

Application Examples

Perform the following steps to save or recall the waveform recorded.

- Press the **ACQUIRE** key to display the **ACQUIRE** menu.
- Press the **RECORD** softkey to display the **RECORD** menu.
- Press the **Mode** softkey to select **Save/Recall** mode.
- Press the **Start Frame** softkey and turn the entry knob to set the start frame.
- Press the **End Frame** softkey and turn the entry knob to set the end frame.
- Press the **Internal Storage** softkey to save or load the recorded waveform from the internal memory.



Application Examples

Cursor Measurements

You can use the cursors to quickly take time and voltage measurements on a waveform. You can use the cursors to measure the amplitude and frequency of a FFT waveform. You can also use the cursors to measure the phase difference between two signals with the same frequency when X-Y horizontal mode is selected.



Measure the time and amplitude characteristics of a waveform

Perform the following steps to take time and frequency measurements.

- Press the **CURSOR** key to display the **CURSOR** menu.
- Press the **Mode** softkey to select the **Manual** mode.
- Press the **Type** softkey to select the **Time** type.
- Press the **X1--/X2—** softkey or press the entry knob to select the X1 cursor.
- Rotate the entry knob  to move the X1 cursor.
- Press the **X1--/X2—** softkey or press the entry knob to select the X2 cursor.
- Rotate the entry knob  to move the X2 cursor.
- ΔX and $1/\Delta X$ are displayed in the softkey area. ΔX is the time difference between X1 and X2; $1/\Delta X$ is the frequency “between” X1 and X2.

Application Examples



Perform the following steps to make a voltage measurement on a waveform.

- Press the **CURSOR** key to display the **CURSOR** menu.
- Press the **Mode** softkey to select the **Manual** mode.
- Press the **Type** softkey to select the **Voltage** type.
- Press the **Y1--/Y2--** softkey or press the entry knob to select the Y1 cursor.
- Rotate the entry knob  to move the Y1 cursor.
- Press the **Y1--/Y2--** softkey or press the entry knob to select the Y2 cursor.
- Rotate the entry knob  to move the Y2 cursor.
- The ΔY displayed in the softkey area is the voltage difference between Y1 and Y2.

Application Examples

Measure the frequency and amplitude of an FFT signal



Perform the following steps to take frequency measurements.

- Press the **MATH** key to display the **Math** menu.
- Press the **Operate** softkey to select **FFT** and display the **FFT** menu.
- Press the **CURSOR** key to display the **CURSOR** menu.
- Press the **Mode** softkey to select the **Manual** mode.
- Press the **Source** softkey to select **FFT**.
- Press the **Type** softkey to select the **Time** type.
- Press the **X1--/X2--** softkey or press the entry knob to select the X1 cursor.
- Rotate the entry knob  to move the X1 cursor.
- Press the **X1--/X2--** softkey or press the entry knob to select the X2 cursor.
- Rotate the entry knob  to move the X2 cursor.
- The ΔX displayed in the softkey area is the frequency difference between X1 and X2. $1/\Delta X$ is the time difference between X1 and X2.

Perform the following steps to take amplitude measurements on an FFT signal



- Press the **MATH** key to display the **Math** menu.
- Press the **Operate** softkey to select **FFT** and display the **FFT** menu.

Application Examples

- Press the **CURSOR** key to display the **CURSOR** menu.
- Press the **Mode** softkey to select the **Manual** mode.
- Press the **Source** softkey to select **FFT**.
- Press the **Type** softkey to select the **Voltage** type.
- Press the **Y1--/Y2--** softkey or press the entry knob to select the Y1 cursor.
- Rotate the entry knob  to move the Y1 cursor.
- Press the **Y1--/Y2--** softkey or press the entry knob to select the Y2 cursor.
- Rotate the entry knob  to move the Y2 cursor.
- The ΔY displayed in the softkey area is the voltage difference between Y1 and Y2.

Application Examples

Measure the Phase Difference Between Two Signals of the Same Frequency under X-Y Display Mode.

- Connect a sine wave signal to channel 1 and a sine wave signal of the same frequency but different phase to channel 2.
- Press the horizontal **MENU** key to display the **Horizontal** menu.
- Press the **X-Y** softkey to select the **X-Y** display mode.
- Center the signal on the display with the vertical position knob of each channel.
- Use the vertical scale control knob of each channel to expand the signal for convenient view.
- Press the **CURSOR** key to display the **CURSOR** menu.
- Press the **Mode** softkey to select the **Manual** mode.
- Press the **Source** softkey to select **CH2**.
- Press the **Type** softkey to select the **Voltage** type.
- Press the **Y1--/Y2--** softkey or press the entry knob to select the Y1 cursor.
- Rotate the entry knob  to move the Y1 cursor to the top of the signal.
- Press the **Y1--/Y2--** softkey or press the entry knob to select the Y2 cursor.
- Rotate the entry knob  to move the Y2 cursor to the bottom of the signal.

Application Examples

- The ΔY displayed in the softkey area is the voltage difference D (or 2B) between Y1 and Y2.
- Press the **Y1-/Y2-** softkey or press the entry knob to select the Y1 cursor.
- Rotate the entry knob \curvearrowright to move the Y1 cursor to the upper intersection of the signal and the Y axis.
- Press the **Y1-/Y2-** softkey or press the entry knob to select the Y2 cursor.
- Rotate the entry knob \curvearrowright to move the Y2 cursor to the lower intersection of the signal and the Y axis.
- The ΔY displayed in the softkey area is the voltage difference C (or 2A) between Y1 and Y2.
- Calculate the phase difference using the formulas
$$\theta = \pm \arcsin \frac{C}{D} \text{ or } \theta = \arcsin \frac{A}{B}.$$

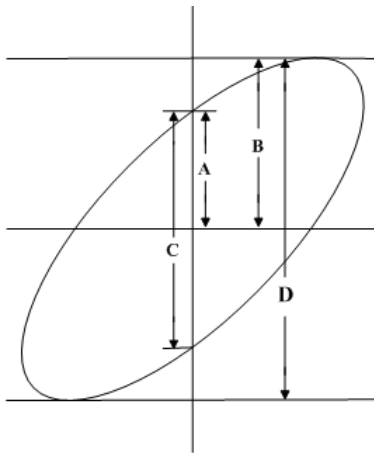

4. System Message and General Problems

System Message

Function is not available: The control knob, key, or softkey is not available under a specific operating condition.

The control is at its limit: This message will be displayed when the maximum or minimum value is reached by turning the Entry knob, Vertical Control knobs, Horizontal Control knobs, or Trigger Level knob.

Total is at its maximum: This message will be displayed when the maximum value of Total count for PASS/FAIL is reached.

Record is completed: This message will be displayed when the number of waveforms (set in the **End Frame** softkey) have been recorded.

No external memory: This message will be displayed when you try to save a file to an external mass storage device which has not been installed.

Save error: This message will be displayed when a failure to save a file to the internal or external memory occurs.

Empty storage memory: This message will be displayed when you try to load a file which does not exist from the internal memory.

Unrecognized file: This message will be displayed when you try to load a file which cannot be recognized by the oscilloscope.

Update failed: This message will be displayed when a software update has failed.

No record data: This message will be displayed when you try to save a record file without record data.

Record is failed: This message will be displayed when waveform record is failed.

Factory setup is recalled: This message will be displayed when the default factory configuration is recalled.

No signal is found: This message will be displayed when you press the **AUTO** key without any signal connected to either channel.

Invalid data: This message will be displayed when you try to save a *.CSV file without any valid CSV data.

Load finished: This message will be displayed when a file has been successfully loaded from the internal or external memory.

Save finished: This message will be displayed when a file has been successfully saved to the internal or external memory.

System Message and General Problems

Incompatible file: This message will be displayed when the update software is not compatible with the model type.

Load error: This message will be displayed when you fail to load a file from the internal or external memory.

Restart to complete updating: This message will be displayed to let you restart (power cycle) the oscilloscope when the software update is successfully finished.

USB device is installed: This message will be displayed when a USB device is connected and recognized by the oscilloscope.

USB device is removed: This message will be displayed when a USB device is removed from the oscilloscope.

Print finished: This message will be displayed when the current waveform is printed successfully.

Print failed: This message will be displayed when the current waveform is not printed successfully.

USB host error: This message will be displayed when the USB host control circuit is not working correctly.

Setup finished: This message will be displayed when the date and time are set successfully.

Setup failed: This message will be displayed when the date and time are not set successfully.

System Message and General Problems

General Problems

If there is no display on the screen:

- Check that the power cord is connected to the oscilloscope and to a live power source.
- Check that the power switch is on.
- Check that the display contrast is adjusted properly.
- Contact B+K Precision if there is still no display.

If there is no waveform displayed:

- Check that the oscilloscope probe is properly connected to the BNC connector and that the probe clips make good contact with the probe lead wires.
- Check that the probe clips are securely connected to points in the circuit under test and that the probe ground clip is connected to the circuit ground.
- Check that the circuit under test is powered on.
- Press the **AUTO** key again.

If the waveform display is not stable:

- Check that the trigger source channel is actually the channel to which the signal is connected.
- Check that the proper trigger type is selected. The video type is only used to trigger on a video signal. The proper trigger type is essential for a stable display.

System Message and General Problems

- Try using HF Reject or LF Reject to reduce the noise of the trigger signal.

If the amplitude is not identical with the actual voltage:

- Check that the attenuation factor of the probe corresponds to the attenuation factor set in the channel menu.

5. Specifications and Characteristics

Characteristics

The characteristics given below are typical performance values and are not warranted. Characteristics are valid after a 30 minute warm-up time and within $\pm 5^\circ\text{C}$ of the last self-calibration temperature.

Vertical system

Scope channels	2 channels plus external trigger input.
Bandwidth	60 MHz: 2534, 2540
	100 MHz: 2542
Calculated rise time (=0.35/bandwidth)	5.83 ns: 2534, 2540
	3.50 ns: 2542
Coupling	AC, DC, GND
BW Limit	20 MHz selectable
Vertical sensitivity	2mV/div – 5V/div, 1-2-5 sequence
DC Vertical Gain Accuracy	2 mV/div to 5 mV/div: $\pm 4\%$
	10 mV/div to 5 V/div: $\pm 3\%$

DC Measurement Accuracy	2 mV/div to 5 mV/div range: $\pm(4\% \times \text{reading} + 0.1 \times \text{V/div} + 0.5 \text{ mV})$
	10 mV/div to 5 V/div range: $\pm(3\% \times \text{reading} + 0.1 \times \text{V/div} + 1.0 \text{ mV})$
Position range	± 8 divisions from the center of the screen
Attenuation factor	$\times 1, \times 10, \times 100, \times 1000$
Channel common mode rejection	100:1 at 60Hz
	20:1 at 10MHz
Lower frequency limit, AC coupled	$\leq 5\text{Hz}$ at BNC
	$\leq 1\text{Hz}$ when using a 10X passive probe
Channel to channel crosstalk	$\geq 100:1$ at 1MHz
	$\geq 100:1$ at 10MHz
Input Impedance	$1 \text{ M}\Omega \pm 1\% \parallel 19 \text{ pF}$
Maximum input	CAT II, 400V_{pk}
Differential delay	150 ps between two channels with the same scale and coupling settings

Specifications

Horizontal system

Time base range	2.5 ns/div to 50 s/div (2534) 2 ns/div to 50 s/div (2540, 2542)
Modes	Main, Delayed, Roll, and X-Y
Time base accuracy	±0.01%
Input of X-Y mode	Channel 1 is the X-axis input Channel 2 is the Y-axis input
Bandwidth of X-Y mode	60 MHz: 2534, 2540 100 MHz: 2542
Phase error of X-Y mode	±3°

Measurements

Voltage measurement	Maximum, Minimum, Peak-to-Peak, High, Low, Amplitude, Average, RMS, Cycle Average, Cycle RMS, Overshoot, Preshoot
Time measurement	Frequency, Period, +Width, -Width, +Duty, -Duty, Rise time, Fall time, Delay, Phase, X at MAX, X at MIN
Math	CH1-CH2, CH1+CH2, CH1×CH2, FFT (2k points)
Cursors	Manual, Automatic and Track
Counter	Built-in 5-digit frequency counter. Count up to the oscilloscope's maximum bandwidth.

Trigger system

Source	CH1, CH2, EXT, EXT/5, AC Line, Alternating.
Modes	Auto, Normal, Single
Coupling	DC, AC, LF-Reject, HF-Reject
Type	Edge, Pulse, Video
Trigger sensitivity, Edge Trigger Type, DC coupling	CH1,CH2: 1div from DC to 10MHz EXT: 100mV from DC to 10MHz 200mV from 10MHz to full Bandwidth EXT/5: 500mV from DC to full Bandwidth
Trigger sensitivity, Edge Trigger Type, AC coupling	Same as DC coupling at 50 Hz and above
Trigger sensitivity, Edge Trigger Type, LF REJ	Same as the DC coupling limits for frequencies above 100kHz, attenuates signals below 8kHz
Trigger sensitivity, Edge Trigger Type, HF REJ	Same as the DC coupling limits from DC to 10kHz, attenuates signals above 150kHz
Trigger sensitivity, Video Trigger Type	Internal: Pk to Pk amplitude of 2 divisions EXT: 400 mV EXT/5: 2V
Signal formats and Field Rates, Video Trigger Type	Supports NTSC, PAL, and SECAM broadcast systems for any field or any line
Trigger level range	±8 divisions from screen center

	EXT: $\pm 1.6V$ EXT/5: $\pm 8V$
Holdoff Range	100ns to 1.5s
Trigger Level Accuracy	Internal: $\pm 0.3 \text{ div} \times \text{volts/div}$
Input impedance	$1M\Omega \pm 1\% 19pF$
Maximum input	CAT II, $400V_{pk}$ @ $1M\Omega$
SET LEVEL TO 50%	Operates with input signal $\geq 50 \text{ Hz}$.
Pulse Width Trigger mode	Trigger when Less than, Greater than, Equal Positive pulse , Negative pulse
Pulse Width Range	20ns to 10s

Specifications

Storage and IO

Internal memory	10 setups and waveforms can be saved and recalled internally.
File format	Setup file (*.STP), Waveform file (*.WFM), BMP file (*.BMP), CSV file (*.CSV). Files can be saved with real time stamp (date, time)
Standard ports	USB host USB device

Acquisition system

Max. real-time sample rate	400 MSa/s: 2534 1 GSa/s: 2540, 2542
Max. equivalent sample rate	40 GSa/s: 2534 50 GSa/s: 2540, 2542
Memory Depth	4000 points
Vertical resolution	8 bits
Sample mode	Normal, Average, Peak Detect
Autoset	Finds and displays all active channels. Sets edge trigger mode on lowest channel, sets vertical sensitivity on for both channels and time base to display one or five periods. Requires minimum voltage $> 10 \text{ mVpp}$, 0.5% duty and minimum frequency $> 50 \text{ Hz}$.

Specifications

Display system

Display	5.7 inch (145cm) diagonal STN LCD.
Resolution	240 vertical by 320 horizontal pixels
Color	256 VGA colours
Brightness	Adjustable
Language	Multi language user interface
Display area	Menu ON: 8 vertical by 10 horizontal divisions or 200 vertical by 250 horizontal pixels Menu OFF: 8 vertical by 12 horizontal divisions or 200 vertical by 300 horizontal pixels
Display mode	Vector, Dots
Interpolation	Sinx/x, Linear
Persistence	Off, Infinite persistence

Power and environmental requirements

Line voltage	99V to 242VAC
Line frequency	47Hz to 440Hz
Power consumption	Less than 50VA
Operating temperature	0°C to 40°C
Non-operating temperature	-20°C to 55°C
Humidity	≤90% relative humidity
Operating altitude	≤3000m
Non-operating altitude	≤15000m

Physical size and Weight

Instrument height	147 mm
Instrument width	310 mm
Instrument depth	269 mm
Compartment height	57 mm
Compartment width	225 mm
Compartment depth	189 mm
Net weight	Approximately 3.6kg

Calibration interval

Recommended calibration interval	One year
----------------------------------	----------

Appendix A: Service and Warranty Information

Service Information

Warranty Service: Please return the product in the original packaging with proof of purchase to the address below. Clearly state in writing the performance problem and return any leads, probes, connectors and accessories that you are using with the device.

Non-Warranty Service: Return the product in the original packaging to the address below. Clearly state in writing the performance problem and return any leads, probes, connectors and accessories that you are using with the device. Customers not on open account must include payment in the form of a money order or credit card. For the most current repair charges please visit www.bkprecision.com and click on “service/repair”.

Return all merchandise to B&K Precision Corp. with pre-paid shipping. The flat-rate repair charge for Non-Warranty Service does not include return shipping. Return shipping to locations in North American is included for Warranty Service. For overnight shipments and non-North American shipping fees please contact B&K Precision Corp.

B&K Precision Corp.
22820 Savi Ranch Parkway
Yorba Linda, CA 92887
www.bkprecision.com
714-921-9095

Include with the returned instrument your complete return shipping address, contact name, phone number and description of problem.

Limited Two-Year Warranty

B&K Precision Corp. warrants to the original purchaser that its products and the component parts thereof, will be free from defects in workmanship and materials for a period of 2 years from date of purchase.

B&K Precision Corp. will, without charge, repair or replace, at its option, defective product or component parts. Returned product must be accompanied by proof of the purchase date in the form of a sales receipt. To obtain warranty coverage in the U.S.A., this product must be registered by completing a warranty registration form on www.bkprecision.com within fifteen (15) days of purchase.

Exclusions: This warranty does not apply in the event of misuse or abuse of the product or as a result of unauthorized alterations or repairs. The warranty is void if the serial number is altered, defaced or removed.

B&K Precision Corp. shall not be liable for any consequential damages, including without limitation damages resulting from loss of use. Some states do not allow limitations of incidental or consequential damages. So the above limitation or exclusion may not apply to you.

This warranty gives you specific rights and you may have other rights, which vary from state-to-state.

B&K Precision Corp.
22820 Savi Ranch Parkway
Yorba Linda, CA 92887
www.bkprecision.com
714-921-9095



22820 Savi Ranch Parkway
Yorba Linda, CA 92887
www.bkprecision.com

© 2008 B&K Precision Corp.

Printed in China