

INSTALLATION MANUAL

200 SERIES



200P, 250P and 250D



Aqua-Hot 200 Series Installation Manual

| | |
|--|----|
| Cautions and Introductions..... | 2 |
| Aqua-Hot Hydronic Heating System | |
| Safety Precautions and Instructions | 3 |
| Heating System Features..... | 6 |
| 250D Components..... | 7 |
| 200P/250P Components | 8 |
| Aqua-Hot Installation | |
| Installing the Aqua-Hot..... | 9 |
| Aqua-Hot Measurement Diagrams | 10 |
| Mounting Brackets | 11 |
| Installing the Expansion Bottle | 12 |
| Hydronic Heating System | |
| Heat Exchanger Floor Plan..... | 13 |
| Heat Exchanger Installation Requirements | 14 |
| Mounting the Heat Exchangers | 15 |
| Location, Clearances and Boost Pump | 16 |
| Wiring the Heat Exchangers..... | 17 |
| Wiring for OEM RV-C or Multiplex | 17 |
| Plumbing the Hydronic Heating System | 18 |
| Domestic Water System | |
| Requirements and Plumbing | 20 |
| Switch Panel | |
| Switch Panel Location, Mounting | 21 |
| 250D Switch Panel Rear View | 22 |
| 200P/250P Switch Panel Rear View | 23 |
| Fuel System | |
| Propane Fuel Specifications | 24 |
| Diesel Fuel Specifications..... | 25 |
| Exhaust System | |
| Exhaust System Requirements..... | 27 |
| Installing the Exhaust System..... | 27 |
| Wiring Specifications | |
| Wiring Harness Pin-Out | 30 |
| Connecting the 200P and 250P to DC Power | 31 |
| Connecting the 250D to DC Power..... | 32 |
| Connecting the 250P or 250D to AC Power | 33 |
| Purging the System | |
| Purging the Hydronic Heating System | 34 |
| Initial Start Up | |
| Activating the Aqua-Hot..... | 35 |

Appendices

| | |
|---|-----------|
| Appendix A: 250P Wiring Schematic..... | 36 |
| Appendix B: 200P Wiring Schematic | 37 |
| Appendix C: 250D Wiring Diagram..... | 38 |
| Appendix D: Measuring Antifreeze Concentration..... | 39 |
| Parts and Accessories | 40 |
| Warranty..... | 47 |

About the Aqua-Hot 200 Series

The Aqua-Hot 200P, 250P, and 250D are hydronic (water based) heating systems that provide interior heat and tank-less, continuous hot water in one small, easy to install package.

The heating system provides moist, quiet, comfortable interior heat. The Aqua-Hot is equipped with one thermostatically controlled temperature zone.

The tank-less hot water system produces 90 gallons per hour (1.5 GPM) of continuous hot water.

These TribridHot™ systems use one or a combination of heat sources to heat FDA-approved “Generally Recognized As Safe” (henceforth referred to as “GRAS”) propylene glycol based antifreeze solution in the Aqua-Hot’s boiler tank.

The 200P uses a 12V DC powered propane burner to heat the system and **does not** have an electric element. The propane burner is to be used for any and all heating or hot water needs.

The 250P and 250D employ a 12V DC burner (propane and diesel, respectively) as the primary heating source. The burner should be used for continuous hot water, and heating in cold conditions. In addition to a burner, the 250P and 250D models also employ a 120V AC 1000W electric heating element as a supplemental heating source. Once the tank has reached temperature by way of the 12V DC burner, the electric element may be engaged to provide light-duty hot water and heating needs, and serves to maintain tank temperature during periods which the heater is not in use. For continuous hot water and heat in cold conditions, the burner **must** be active.

Should additional assistance be needed, please contact the Product Application Department at +1 (800) 685-4298, Monday through Friday, 7a.m. to 4p.m. Mountain Standard Time.

Caution Notes

As you read this information, take particular note of the NOTICE, CAUTION, WARNING, and DANGER symbols when they appear. This information is important for safe and efficient use of the Aqua-Hot equipment.

NOTICE

NOTICE signals a situation where potential damage to the equipment could occur.



CAUTION

CAUTION signals a situation where potential harm or risk of minor or moderate injury could occur if instructions are not followed.



WARNING

WARNING signals a hazardous situation where potential harm, risk of serious injury or death could result if you do not follow instructions.



DANGER

DANGER signals a situation where immediate risk of serious injury or death will result if you do not follow instructions.

NOTE: This manual will also use notes sections similar to this one to draw attention to features and practices which should be observed.

The Aqua-Hot Heating System

Read and understand all instructions before installing this unit.

- Read this owner's manual before installing or using the Aqua-Hot system to reduce the risk of injury to persons or damage to equipment.
- The product identity label contains specifications of the unit, to what standard it has been tested, and important safety notices.
- The Aqua-Hot must be installed in a compartment that is closed off from living quarters and accessible only from the outdoors.



WARNING

If the information in these instructions are not followed exactly, a fire or explosion may result causing property damage, personal injury, or death.

- Propylene glycol based antifreeze "Generally Recognized As Safe" (GRAS) by the FDA must be utilized for antifreeze and water heating solution.
- An interlock switch prevents the Aqua-Hot heater from operating when the cover is not installed in the correct position.
- Should any additional assistance be needed, please contact the Technical Support Department at +1 (800) 685-4298 or +1 (303) 651-5500.
- Do not store or use gasoline or other flammable vapors or liquids in the vicinity of this or any other appliance
- Disconnect electric wiring to the Aqua-Hot system before welding or plasma cutting the RV or home to avoid damage to equipment
- Air pressure to the tank must NOT exceed 20PSI or it will cause damage
- The Aqua-Hot exhaust is HOT and must be kept away from heat sensitive material
- Use caution when working on or near the propane gas system

- DO NOT connect the 12V DC power to the Aqua-Hot if the RV or home requires welding
- At maximum operating temperatures, the coolant will be very hot and scalding hot vapor or coolant may result in serious burns or injury
- DO NOT activate the burner until the antifreeze and water heating solution has been added to the boiler tank to avoid serious damage to the heater

WHAT TO DO IF YOU SMELL GAS



CAUTION

- Evacuate all persons from the vehicle
- Shut off the gas supply at the gas container or source
- Do not touch any electrical switch or use any phone or radio in the vehicle
- Do not start the engine or electric generator (if equipped)
- Contact the nearest gas supplier or qualified service technician for repairs
- If you cannot contact the nearest gas supplier or qualified service technician, contact the nearest fire department
- Do not turn on the gas supply until the gas leak or leaks (if relevant) have been repaired
- Installation and service must be performed by a qualified installer, service agency or gas supplier

The Aqua-Hot's exhaust is HOT!

- Do NOT park in areas where dry conditions exist (i.e. grassy, dry fields)
- Do NOT operate the burner inside an enclosed building
- The heater must be switched OFF when refueling

| | | | | | | |
|--|--|---|--|---|---|--|
| <h2 style="text-align: center;">NOTICE</h2> <p>This appliance operates on DC power.</p> <p>Use only nontoxic propylene glycol based boiler antifreeze with additives generally recognized as safe ("GRAS") by the FDA.</p> <p>Failure to winterize your heater, when stored in freezing temperatures, will result in serious damage to the product's domestic hot water heating system.</p> <p>Air pressure applied to the tank must not exceed 20 psi. Excess pressure will result in internal damage.</p> <p>For detailed information, reference the owner's manual or contact Aqua-Hot Heating Systems, Inc. at 800-685-4298.</p> | <h2 style="text-align: center;">SAFETY INSTRUCTIONS</h2> <p>A. This appliance does not have a pilot. It is equipped with an ignition device, which automatically lights the burner. Do not try to light the burner by hand.</p> <p>B. BEFORE OPERATING, smell all around the appliance area for gas. Be sure to smell next to the floor because some gas is heavier than air and will settle on the floor.</p> <p>WHAT TO DO IF YOU SMELL GAS</p> <ul style="list-style-type: none"> - Do not try to light any appliance. - Do not touch any electric switch; do not use any phone in your building. - Immediately call your gas supplier from a neighbor's phone. Follow the gas supplier's instructions. - If you cannot reach your gas supplier, call the fire department. <p>C. Use only your hand to push in or turn the gas control knob. Never use tools. If the knob will not push in or turn by hand, don't try to repair it; call a qualified service technician. Forced or attempted repair may result in a fire or explosion.</p> <p>D. Do not use this appliance if any part has been under water. Immediately call a qualified service technician to inspect the appliance and to replace any part of the control system and any gas control which has been under water.</p> | <h2 style="text-align: center;">OPERATING INSTRUCTIONS</h2> <ol style="list-style-type: none"> 1. STOPS! Read the safety information to the left on this label. 2. This appliance is equipped with an ignition device, which automatically lights the burner. Do not try to light the burner by hand. 3. Ensure that the gas control valve is turned on Follow "B" in the safety information to the left on this label. If you don't smell gas, go to the next step. 4. Refer to the Owner's Manual for information regarding normal operation of this heating system. 5. If the appliance will not operate, follow the instructions "To Turn Off Gas To Appliance" below on this label and refer to the Owner's Manual troubleshooting section or call the technical support department at 1-800-685-4298. | <h2 style="text-align: center;">TO TURN OFF GAS TO APPLIANCE</h2> <ol style="list-style-type: none"> 1. Turn off all electric power to the appliance if service is to be performed. 2. Set all interior thermostats to their lowest setting. 3. Turn the gas control knob located on the heater's propane inlet port clockwise to the "OFF" position. | <h2 style="text-align: center;">INSTRUCTIONS DE MISE EN MARCHÉ</h2> <p>1. ARRÊTEZ! Lisez les instructions de sécurité sur la portion à gauche de cette étiquette.</p> <p>2. Cet appareil est muni d'un dispositif d'allumage qui allume automatiquement le brûleur. Ne tentez pas d'allumer le brûleur manuellement.</p> <p>3. Assurez-vous que la soupape de contrôle de gaz est bien ouverte. Passez à l'étape B des instructions de sécurité sur la portion à gauche de cette étiquette. S'il n'y a pas d'odeur de gaz, passez à l'étape suivante.</p> <p>4. Référez au Manuel du propriétaire pour des informations au sujet du fonctionnement normal de ce système de chauffage.</p> <p>5. Si l'appareil ne fonctionne pas, veuillez suivre les instructions « Pour couper le gaz vers l'appareil » ci-dessous sur cette étiquette et référez à la section Dépannage du Manuel du propriétaire ou appelez le service de soutien technique au 1-800-685-4298.</p> | <h2 style="text-align: center;">COMMENT COUPER L'ADMISSION DE GAZ DE L'APPAREIL</h2> <ol style="list-style-type: none"> 1. Coupez l'alimentation électrique de l'appareil s'il faut procéder à l'entretien. 2. Réglez tous les thermostats intérieurs à leur réglage le plus bas. 3. Tournez le bouton de contrôle du gaz, situé sur le port d'entrée de propane du chauffe-eau, vers la droite à la position « OFF » (Arrêt). | |
| <h2 style="text-align: center;">AVIS</h2> <p>Cet appareil fonctionne avec une alimentation C.C.</p> <p>Utiliser uniquement un antigel de chaudière à base de propylène glycol non toxique avec des additifs généralement jugés sans danger « G.JSD » (« GRAS »/generally recognized as safe) par la FDA.</p> <p>Ne pas hiverner l'appareil de chauffage lorsqu'il est entreposé à des températures inférieures à 0 °C provoquera de graves dommages au système de chauffage d'eau chaude domestique du produit.</p> <p>La pression d'air appliquée au réservoir ne doit pas dépasser 20 psi. Tout excès de pression provoquera des dommages internes.</p> <p>Pour des informations détaillées, consulter le manuel d'utilisation et contacter Aqua-Hot Heating Systems, Inc. en composant le 800-685-4298.</p> | <h2 style="text-align: center;">CONSIGNES DE SÉCURITÉ</h2> <p>A. Cet appareil ne comporte pas de veilleuse. Il est muni d'un dispositif d'allumage qui allume automatiquement le brûleur. Ne tentez pas d'allumer le brûleur manuellement.</p> <p>B. AVANT DE FAIRE FONCTIONNER, reniflez tout autour de l'appareil pour détecter une odeur de gaz. Reniflez près du plancher, car certains gaz sont plus lourds que l'air et peuvent s'accumuler au niveau du sol. QUE FAIRE SI VOUS SENTEZ UNE ODEUR DE GAZ :</p> <ul style="list-style-type: none"> - Ne pas tenter d'allumer d'appareil. - Ne touchez à aucun interrupteur, ne pas vous servir des téléphones se trouvant dans le bâtiment. - Appelez immédiatement votre fournisseur de gaz depuis un voisin. Suivez les instructions du fournisseur. - Si vous ne pouvez rejoindre le fournisseur, appelez le service des incendies. <p>C. Ne poussez ou tournez la manette d'admission de gaz qu'à la main; ne jamais utiliser d'outil. Si la manette reste coincée, ne pas tenter de la réparer; appelez un technicien qualifié. Le fait de forcer la manette ou de la réparer peut déclencher une explosion ou un incendie.</p> <p>D. N'utilisez pas cet appareil s'il a été plongé dans l'eau, même partiellement. Faites inspecter l'appareil par un technicien qualifié et remplacez toute partie du système de contrôle et toute commande qui ont été plongés dans l'eau.</p> | <h2 style="text-align: center;">SAFETY INSTRUCTIONS</h2> <p>A. This appliance does not have a pilot. It is equipped with an ignition device, which automatically lights the burner. Do not try to light the burner by hand.</p> <p>B. BEFORE OPERATING, smell all around the appliance area for gas. Be sure to smell next to the floor because some gas is heavier than air and will settle on the floor.</p> <p>WHAT TO DO IF YOU SMELL GAS</p> <ul style="list-style-type: none"> - Do not try to light any appliance. - Do not touch any electric switch; do not use any phone in your building. - Immediately call your gas supplier from a neighbor's phone. Follow the gas supplier's instructions. - If you cannot reach your gas supplier, call the fire department. <p>C. Use only your hand to push in or turn the gas control knob. Never use tools. If the knob will not push in or turn by hand, don't try to repair it; call a qualified service technician. Forced or attempted repair may result in a fire or explosion.</p> <p>D. Do not use this appliance if any part has been under water. Immediately call a qualified service technician to inspect the appliance and to replace any part of the control system and any gas control which has been under water.</p> | <h2 style="text-align: center;">TO TURN OFF GAS TO APPLIANCE</h2> <ol style="list-style-type: none"> 1. Turn off all electric power to the appliance if service is to be performed. 2. Set all interior thermostats to their lowest setting. 3. Turn the gas control knob located on the heater's propane inlet port clockwise to the "OFF" position. | <h2 style="text-align: center;">INSTRUCTIONS DE MISE EN MARCHÉ</h2> <p>1. ARRÊTEZ! Lisez les instructions de sécurité sur la portion à gauche de cette étiquette.</p> <p>2. Cet appareil est muni d'un dispositif d'allumage qui allume automatiquement le brûleur. Ne tentez pas d'allumer le brûleur manuellement.</p> <p>3. Assurez-vous que la soupape de contrôle de gaz est bien ouverte. Passez à l'étape B des instructions de sécurité sur la portion à gauche de cette étiquette. S'il n'y a pas d'odeur de gaz, passez à l'étape suivante.</p> <p>4. Référez au Manuel du propriétaire pour des informations au sujet du fonctionnement normal de ce système de chauffage.</p> <p>5. Si l'appareil ne fonctionne pas, veuillez suivre les instructions « Pour couper le gaz vers l'appareil » ci-dessous sur cette étiquette et référez à la section Dépannage du Manuel du propriétaire ou appelez le service de soutien technique au 1-800-685-4298.</p> | <h2 style="text-align: center;">COMMENT COUPER L'ADMISSION DE GAZ DE L'APPAREIL</h2> <ol style="list-style-type: none"> 1. Coupez l'alimentation électrique de l'appareil s'il faut procéder à l'entretien. 2. Réglez tous les thermostats intérieurs à leur réglage le plus bas. 3. Tournez le bouton de contrôle du gaz, situé sur le port d'entrée de propane du chauffe-eau, vers la droite à la position « OFF » (Arrêt). | <div style="text-align: center;">  <h1 style="font-size: 2em;">200P</h1>  <p>www.aqua-hot.com</p> </div> |

| | | |
|---|---|---|
| <h2 style="text-align: center;">NOTICE</h2> <p>This appliance operates on both AC and DC power.</p> <p>Use only nontoxic propylene glycol based boiler antifreeze with additives generally recognized as safe ("GRAS") by the FDA.</p> <p>Failure to winterize your heater, when stored in freezing temperatures, will result in serious damage to the products domestic hot water heating system.</p> <p>Air pressure applied to the tank must not exceed 20 psi. Excess pressure will result in internal damage.</p> <p>For detailed information, reference the owner's manual or contact Aqua-Hot Heating Systems, Inc. at 800-685-4298.</p> | <h2 style="text-align: center;">SAFETY INSTRUCTIONS</h2> <p>A. This appliance does not have a pilot. It is equipped with an ignition device, which automatically lights the burner. Do not try to light the burner by hand.</p> <p>B. BEFORE OPERATING, smell all around the appliance area for gas. Be sure to smell next to the floor because some gas is heavier than air and will settle on the floor.</p> <p>WHAT TO DO IF YOU SMELL GAS</p> <ul style="list-style-type: none"> -Do not try to light any appliance. -Do not touch any electric switch; do not use any phone in your building. -Immediately call your gas supplier from a neighbor's phone. Follow the gas supplier's instructions. -If you cannot reach your gas supplier, call the fire department. <p>C. Use only your hand to push in or turn the gas control knob. Never use tools. If the knob will not push in or turn by hand, don't try to repair it, call a qualified service technician. Forced or attempted repair may result in a fire or explosion.</p> <p>D. Do not use this appliance if any part has been under water. Immediately call a qualified service technician to inspect the appliance and to replace any part of the control system and any gas control which has been under water.</p> | <h2 style="text-align: center;">OPERATING INSTRUCTIONS</h2> <p>1. STOP! Read the safety information to the left on this label.</p> <p>2. This appliance is equipped with an ignition device, which automatically lights the burner. Do not try to light the burner by hand.</p> <p>3. Ensure that the gas control valve is turned on. Follow "B" in the safety information to the left on this label. If you don't smell gas, go to the next step.</p> <p>4. Refer to the Owner's Manual for information regarding normal operation of this heating system.</p> <p>5. If the appliance will not operate, follow the instructions "To Turn Off Gas To Appliance" below on this label and refer to the Owner's Manual troubleshooting section or call the technical support department at 1-800-685-4298.</p> |
| <h2 style="text-align: center;">AVIS</h2> <p>Cet appareil fonctionne à la fois sur une alimentation a.c. et c.c.</p> <p>Utiliser uniquement un antigel de chaudière à base de propylène glycol non toxique avec des additifs généralement jugés sans danger « GRAS » (« GRAS »/generally recognized as safe) par la FDA.</p> <p>Ne pas hiverner l'appareil de chauffage lorsqu'il est entreposé à des températures inférieures à 0 ° C provoquera de graves dommages au système de chauffage d'eau chaude domestique du produit.</p> <p>La pression d'air appliquée au réservoir ne doit pas dépasser 20 psi. Tout excès de pression provoquera des dommages internes.</p> <p>Pour des informations détaillées, consulter le manuel d'utilisation et contacter Aqua-Hot Heating Systems, Inc. en composant le 800-685-4298.</p> | <h2 style="text-align: center;">CONSIGNES DE SÉCURITÉ</h2> <p>A. Cet appareil ne comporte pas de veilleuse. Il est muni d'un dispositif d'allumage qui allume automatiquement le brûleur. Ne tentez pas d'allumer le brûleur manuellement.</p> <p>B. AVANT DE FAIRE FONCTIONNER, reniflez tout autour de l'appareil pour détecter une odeur de gaz. Reniflez près du plancher, car certains gaz sont plus lourds que l'air et peuvent s'accumuler au niveau du sol. QUE FAIRE SI VOUS SENTEZ UNE ODEUR DE GAZ :</p> <ul style="list-style-type: none"> - Ne pas tenter d'allumer d'appareil. - Ne touchez à aucun interrupteur ; ne pas vous servir des téléphones se trouvant dans le bâtiment. - Appelez immédiatement votre fournisseur de gaz depuis un voisin. Suivez les instructions du fournisseur. - Si vous ne pouvez rejoindre le fournisseur, appelez le service des incendies. <p>C. Ne poussez ou tournez la manette d'admission du gaz qu'à la main; ne jamais utiliser d'outil. Si la manette reste coincée, ne pas tenter de la réparer; appelez un technicien qualifié. Le fait de forcer la manette ou de la réparer peut déclencher une explosion ou un incendie.</p> <p>D. N'utilisez pas cet appareil s'il a été plongé dans l'eau, même partiellement. Faites inspecter l'appareil par un technicien qualifié et remplacez toute partie du système de contrôle et toute commande qui ont été plongés dans l'eau.</p> | <h2 style="text-align: center;">INSTRUCTIONS DE MISE EN MARCHÉ</h2> <p>1. ARRÊTEZ! Lisez les instructions de sécurité sur la portion à gauche de cette étiquette.</p> <p>2. Cet appareil est muni d'un dispositif d'allumage qui allume automatiquement le brûleur. Ne tentez pas d'allumer le brûleur manuellement.</p> <p>3. Assurez-vous que la soupape de contrôle de gaz est bien ouverte. Passez à l'étape B des instructions de sécurité sur la portion à gauche de cette étiquette. S'il n'y a pas d'odeur de gaz, passez à l'étape suivante.</p> <p>4. Référez au Manuel du propriétaire pour des informations au sujet du fonctionnement normal de ce système de chauffage.</p> <p>5. Si l'appareil ne fonctionne pas, veuillez suivre les instructions « Pour couper le gaz vers l'appareil » ci-dessous sur cette étiquette et référez à la section Dépannage du Manuel du propriétaire ou appelez le service de soutien technique au 1 800 685 4298.</p> |
| |  <p style="text-align: center;">Aqua-Hot 250P</p> <p style="text-align: center;">www.aqua-hot.com</p> | <h2 style="text-align: center;">COMMENT COUPER L'ADMISSION DE GAZ DE L'APPAREIL</h2> <p>1. Coupez l'alimentation électrique de l'appareil s'il faut procéder à l'intérieur.</p> <p>2. Réglez tous les thermostats intérieurs à leur réglage le plus bas.</p> <p>3. Tournez le bouton de contrôle du gaz, situé sur le port d'entrée de propane du chauffe-eau, vers la droite à la position « OFF » (Arrêt).</p> |



NOTE: The product label is attached to the side of the Aqua-Hot and provides a ready reference to specifications, test standards and important safety notices.

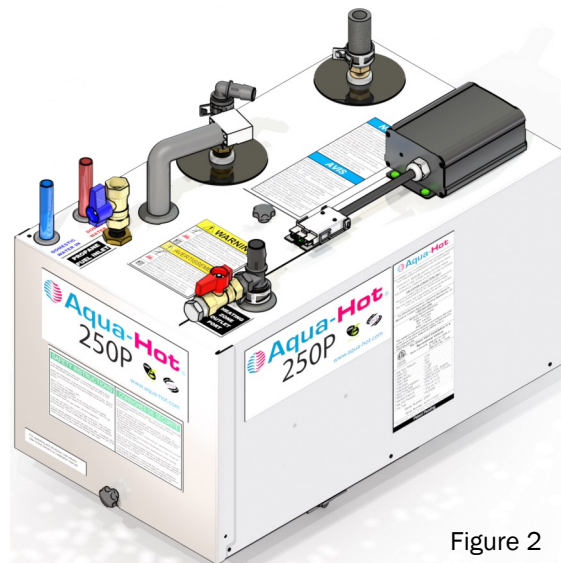

Figure 2

For installation only in a compartment that is completely closed off from living quarters and accessible only from the outdoors.

Combustion Air **MUST BE** supplied from outside the vehicle.
Suitable for water (potable) heating and space heating.
THIS APPLIANCE OPERATES ON DC POWER.
USE COPPER CONDUCTORS ONLY.
Use a 20-Amp fuse for over-current protection for the DC power supply.
Mount the Heater near a bay/storage door so that the Access cover can be easily removed for service.

For Detailed Information, reference the Owner's Manual or contact Aqua-Hot Heating Systems Inc. at 1-800-685-4298.

Minimum Service Clearances
Front - Open Access
Back - 1 Inches
Top - 8 inches
Sides - 1 inches

This appliance must be installed in accordance with local codes or, in the absence of local codes, the Standard for Recreational Vehicles, ANSI A119.2/NFPA 1192 or CAN/CSA-Z240 RV.

For Direct Vent Installation in a Recreational Vehicle.
Meets or Exceeds: ANSI Z21.10.1/C SA 4.1
UL 307B, UL 174
CSA-C22.2 No. 110-94

| | |
|------------------------|------------------------------|
| Max. Tank Pressure | 0 PSI |
| Volts (DC) | 92.5 |
| Tank Capacity | 3.7 gal |
| Orifice Size | 0.089 |
| Volts/Amps | 12VDC, 7.7A |
| Input Firing Rate | 60000 BTU/HR, 17.6 kWh |
| Minimum Inlet Pressure | 8"wc (in. H ₂ O) |
| Manifold Pressure | 10"wc (in. H ₂ O) |
| Max. Inlet Pressure | 13"wc (in. H ₂ O) |
| Fuel Type | PROPANE |

Model Number: 200P
Serial Number: A200-170002

7501 Miller Drive • Frederick, CO 80504 • 1.800.685.4298 • www.aquahot.com

Patent Pending

Figure 1

| | |
|--|----------------------------|
| Burner | |
| Heat Input (Propane)..... | 60,000 BTU/hr ± 10% |
| Heat Input (Diesel) | 66,000 BTU/hr ± 10% |
| Fuel Consumption (Propane)..... | 0.66 gallon/hr |
| Fuel Consumption (Diesel)..... | 0.40 gallon/hr |
| Electric Heating Element (250P/250D only) | |
| Power Consumption | 1000W |
| Voltage | 120V AC |
| Maximum DC Power Consumption | |
| Power Consumption (Propane)..... | 42W |
| Power Consumption (Diesel) | 108W |
| Voltage | 12V DC |
| Zone Heat Circulation | |
| Pumps | 1 |
| Power Consumption | 21W |
| Voltage | 12V DC |
| Heating Zones | |
| Maximum | 1 |
| Domestic Water Heating | |
| Continuous Supply | 1.5 gallon/min |
| Specifications | |
| Dimensions..... | 17.2"H x 12.46"W x 22.44"L |
| Dry Weight | 84 lbs. |
| Wet Weight | 104 lbs. |

NOTICE

All vehicle installations must comply with the requirements listed in the Recreational Vehicle Industry Association's (RVIA) ANSI/NFPA 1192 Handbook for Recreational Vehicle Standards. To receive a copy of this handbook and other pertinent RVIA Standards, write to:
 Recreational Vehicle Industry Association
 1896 Preston White Dr
 PO Box 2999, Reston, VA 22090-0999
 Or contact them by phone at +1 (703) 620-6003, or online at www.rvia.org, or www.nfpa.org

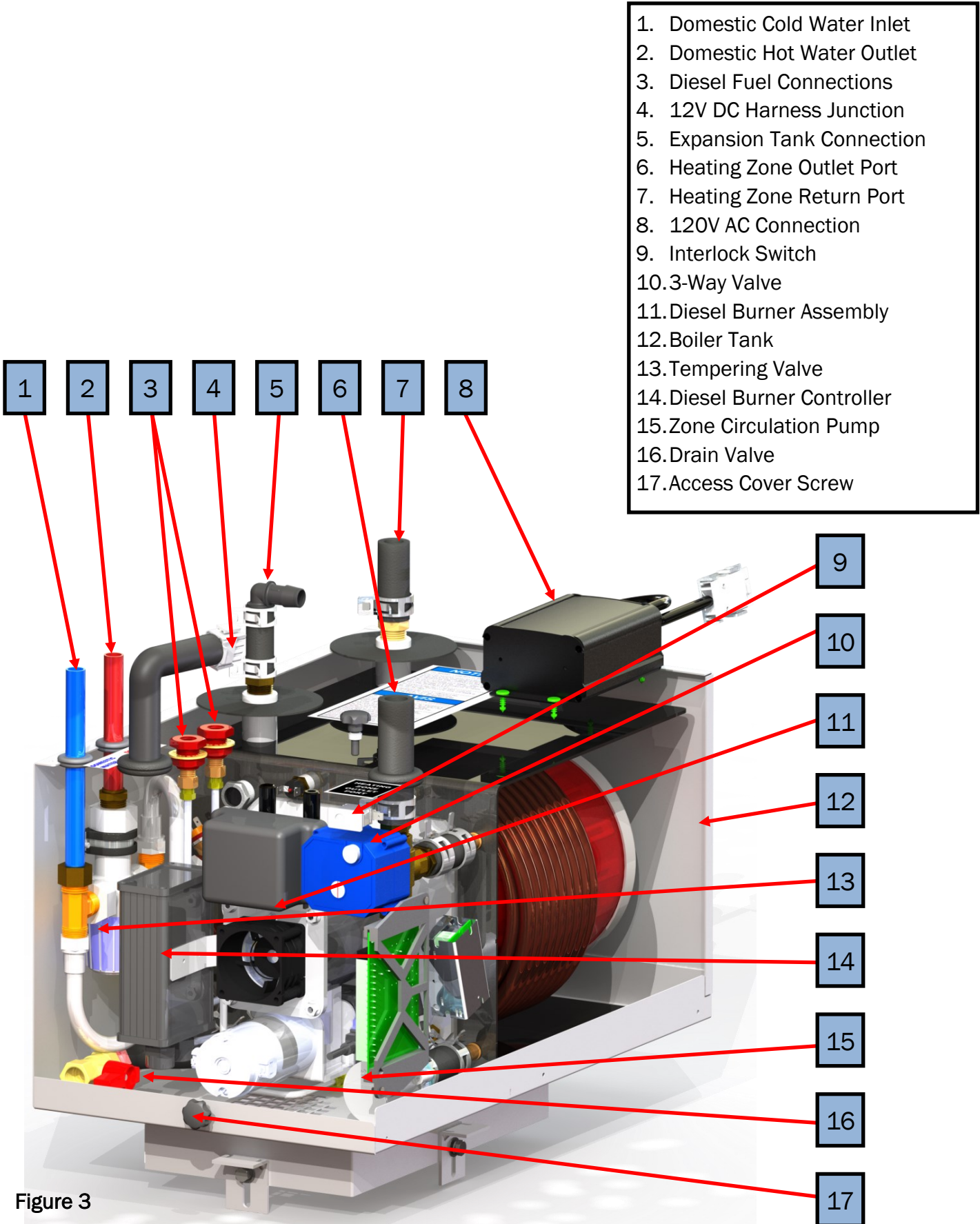

1. Domestic Cold Water Inlet
2. Domestic Hot Water Outlet
3. Diesel Fuel Connections
4. 12V DC Harness Junction
5. Expansion Tank Connection
6. Heating Zone Outlet Port
7. Heating Zone Return Port
8. 120V AC Connection
9. Interlock Switch
10. 3-Way Valve
11. Diesel Burner Assembly
12. Boiler Tank
13. Tempering Valve
14. Diesel Burner Controller
15. Zone Circulation Pump
16. Drain Valve
17. Access Cover Screw

Figure 3

1. Domestic Cold Water Inlet
2. Hot Water Outlet
3. Propane Inlet Ball Valve
4. 12V DC Harness Junction
5. Expansion Tank Connection
6. Heating Zone Outlet Port
7. Heating Zone Return Port
8. 120V AC Electrical Relay Box (250P Only)
9. Propane Burner Assembly
10. Tempering Valve
11. Boiler Tank
12. 3-Way Valve
13. Propane Burner Controller
14. Interlock Switch
15. Drain Valve
16. Zone Circulation Pump
17. Access Cover Screw

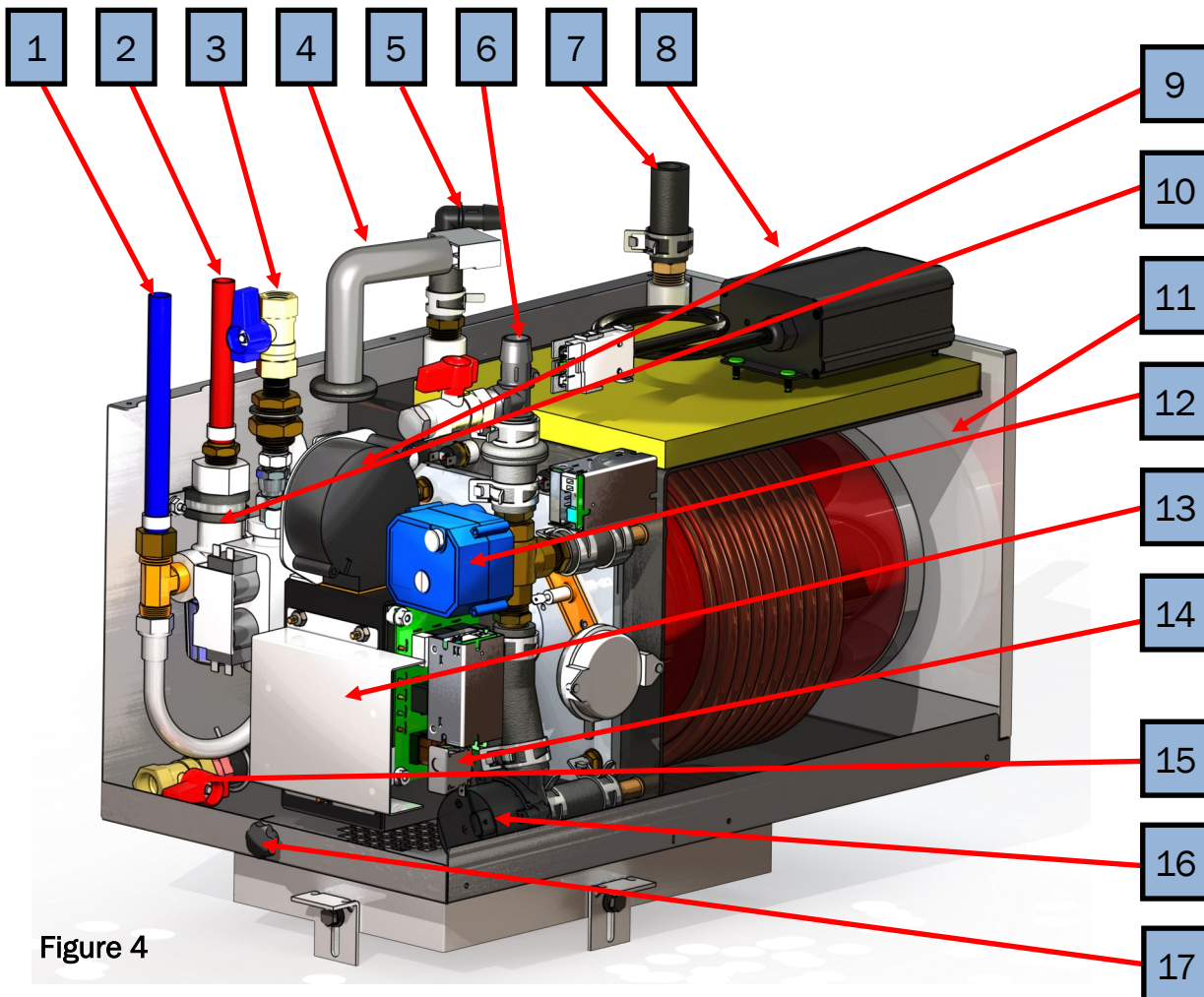

Figure 4

Installing the Aqua-Hot

The Aqua-Hot must be installed in a compartment that is completely closed off from living quarters and accessible only from the outdoors.

1. Reference the following illustrations for mounting information
2. Cut out the required mounting flange opening. Reference figure 6 on the next page.
3. Install the flange located on the bottom of the Aqua-Hot into the cutout opening. Reference figure 8 and figure 9
4. Take the angle brackets and included 1/4-20 bolts and washers. Install the angle brackets into the nuts located on the flanges.
 - Front view Aqua-Hot dimensions reference figure 5.
 - Floor cut-out information reference figure 6, page 10
 - I.D. Label noting the clearance requirement for the front of the heater reference page 6.
 - Reference the I.D. label on page 6 for service access clearance

NOTE: Inspect the area beneath the mounting location to ensure that no structural members will interfere with the cut-out for the mounting flange.

Verify that a support structure of adequate strength has been constructed for the Aqua-Hot.

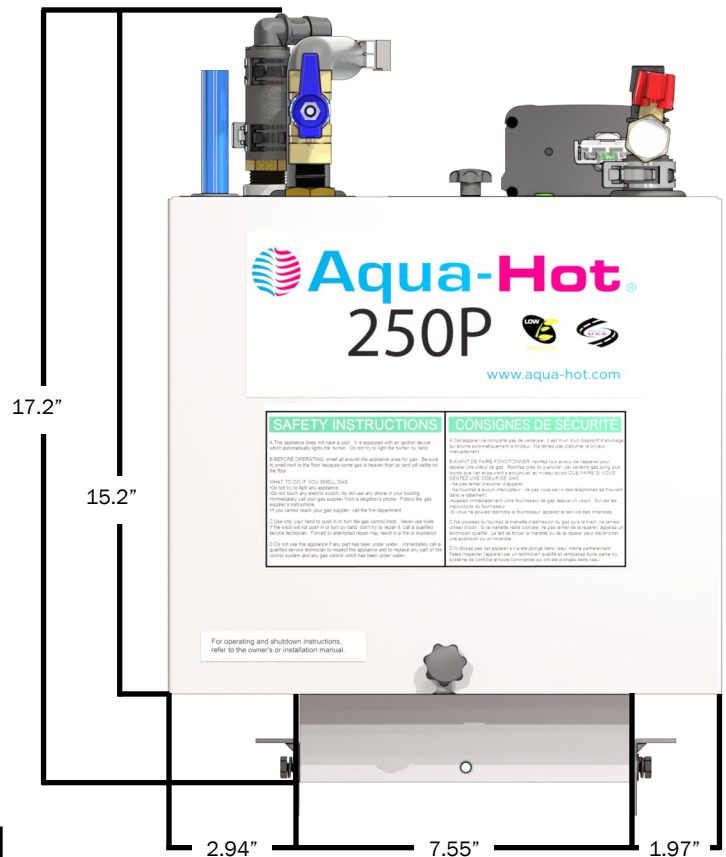

Figure 5

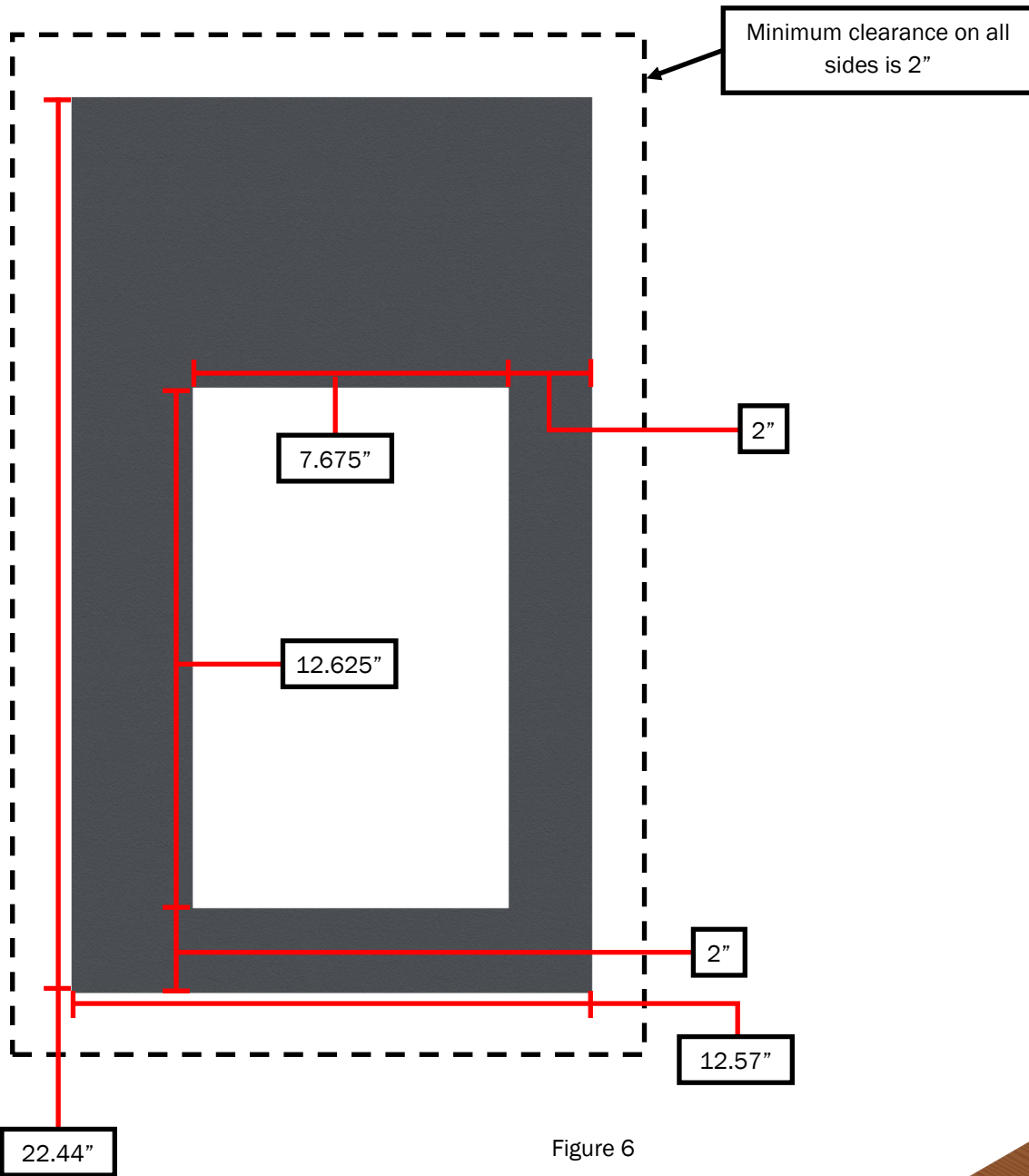

Figure 6

NOTE: The mounting flange of the Aqua-Hot is not centered on the body of the heater. Reference figure 6 for correct dimensions to construct the surface on which the Aqua-Hot will be mounted.

Additional cross-members are required if the existing structure is unable to support 104 lbs.

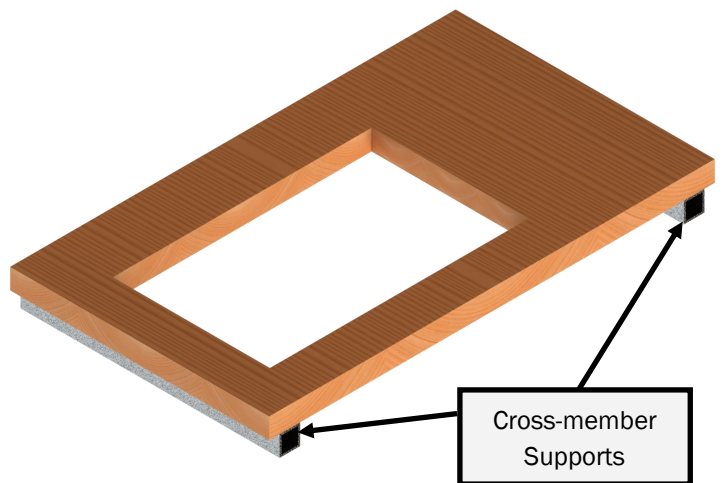

Figure 7

Seat the Aqua-Hot in the flange cut out

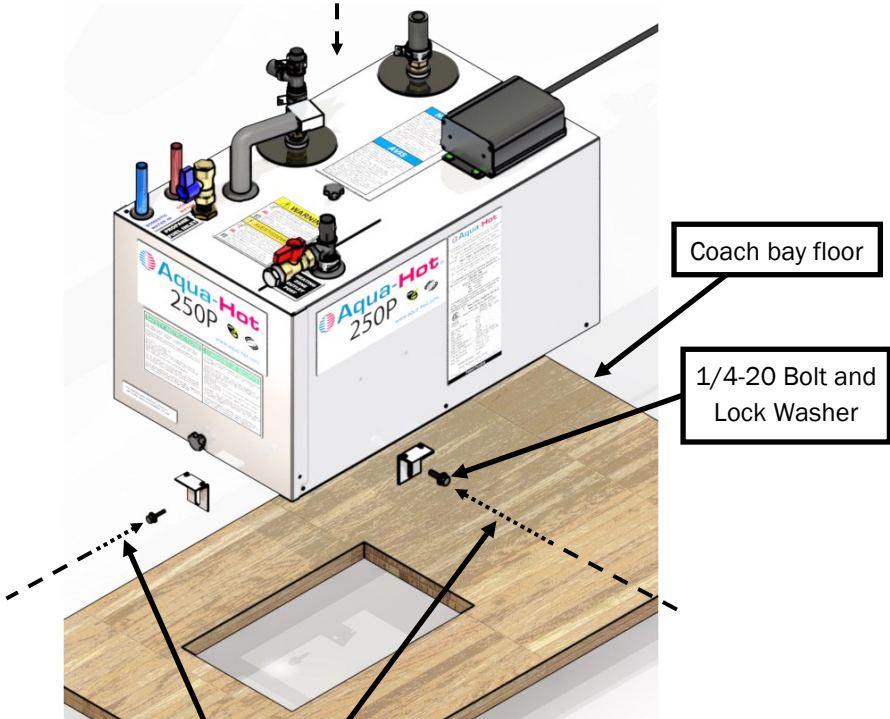

Figure 8

NOTE: Angle mounting bracket must be flush to the underside of the coach floor and flush to the heater flange. Tighten bolts to roughly 76 in-lbs.

1/4-20 Bolt and lock washer

Mounting Bracket

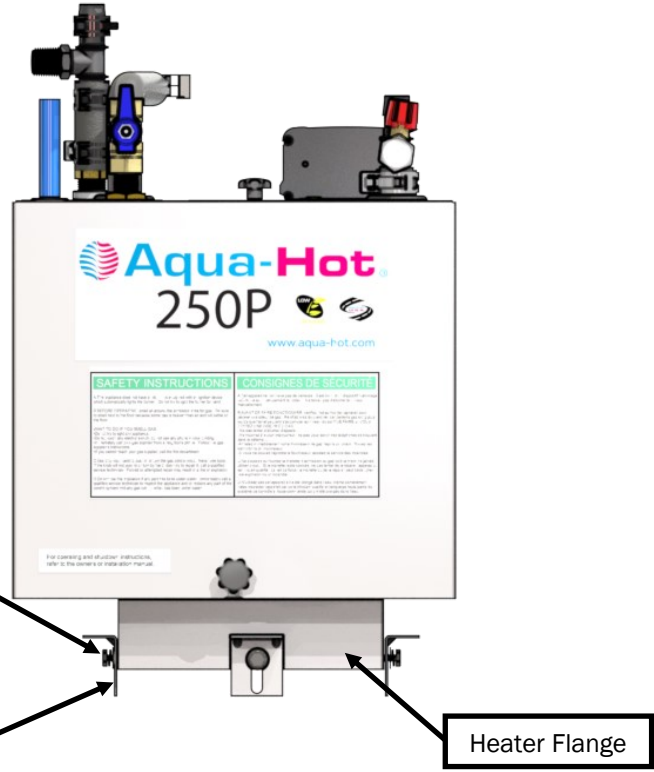



Figure 9

Installation of the Expansion Bottle

1. Select a mounting location that allows for easy access and clear visibility whenever the storage bay containing the expansion bottle is open
2. Mount the expansion tank as illustrated in figure 10.
3. Connect and clamp the overflow tubing from the expansion tank to the Aqua-Hot's expansion tank connection. Reference figure 10.
4. Drill a hole in the bay floor and cut a piece of overflow tubing (included with unit) of adequate length so that it can be connected to the top of the expansion tank and extend through the bay floor. The expansion hose should vent to the exterior of the Aqua-Hot bay.

 **CAUTION**

The Aqua-Hot tank and heating loop operates at 0.0 psi (zero pressure system). Air pressure applied to the tank **MUST NOT** exceed 20 psi. Excess pressure will result in internal damage.

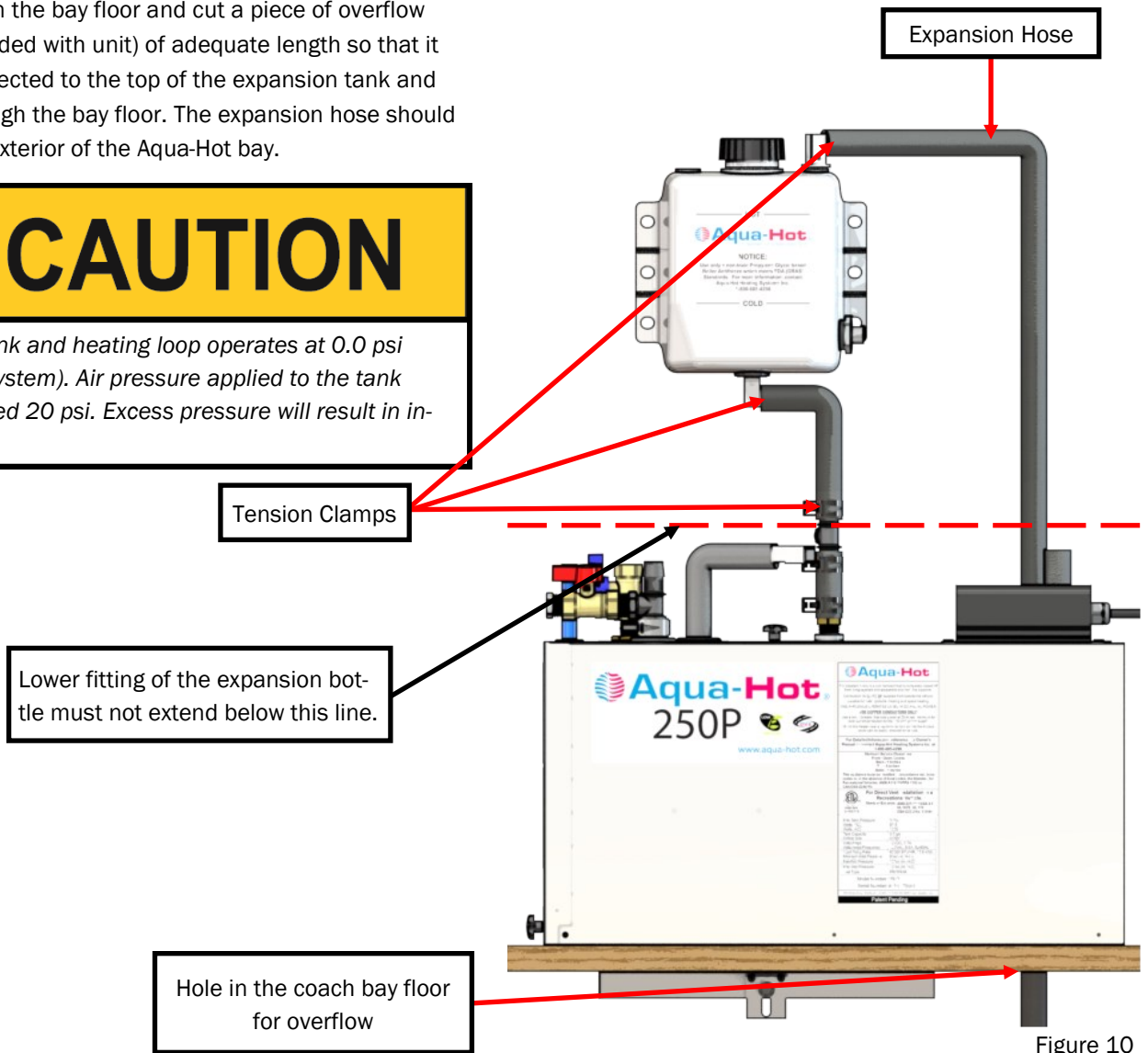

NOTE: Avoid any dips and bends in the overflow tubing from the Aqua-Hot to the expansion tank as air can become trapped in these dips and bends. This will prevent the expansion of the heating solution from properly depositing in the expansion tank.

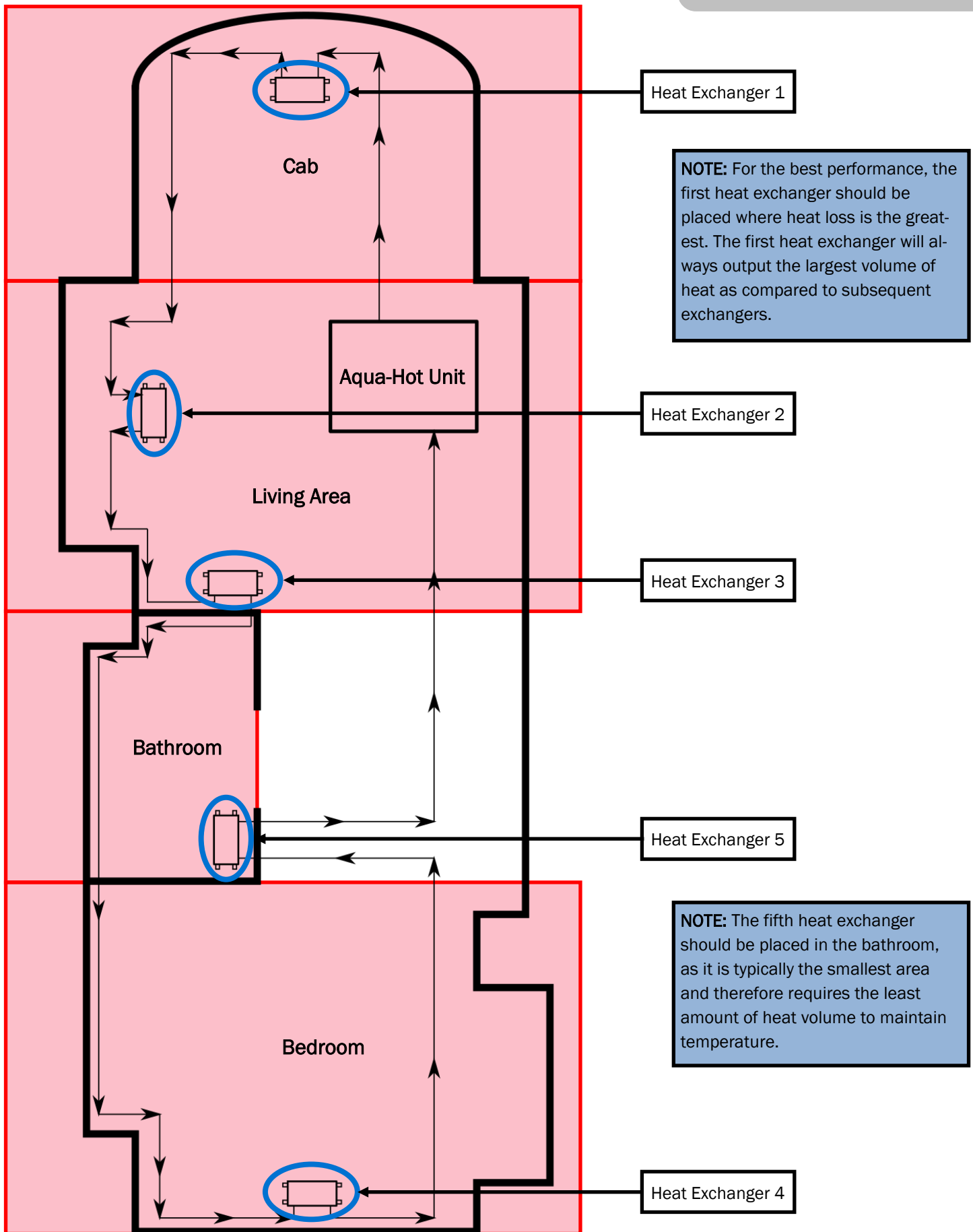

Installation Requirements

Sufficient ventilation must be supplied to each interior heat exchanger. Installing heat exchangers without sufficient ventilation will severely impact the performance of the heat exchanger. An air inlet of approximately the same size as the air outlet is recommended for this application.

Air supplied to the heat exchangers **MUST** be supplied from the living areas. It is **never** acceptable for the supply air to a heat exchanger to be drawn from the bay area.

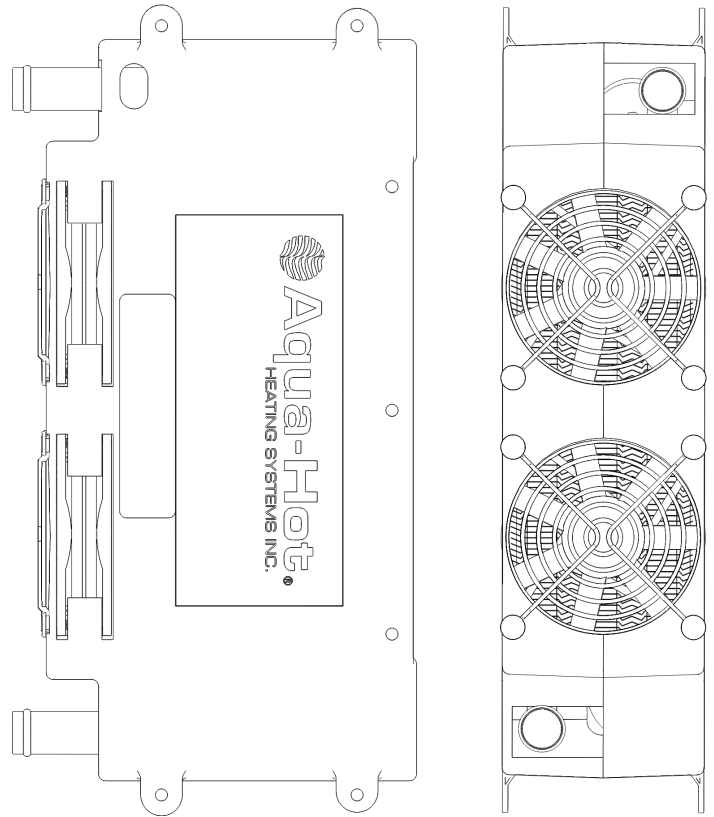

Horizontal and vertical mounting options shown above

Figure 11

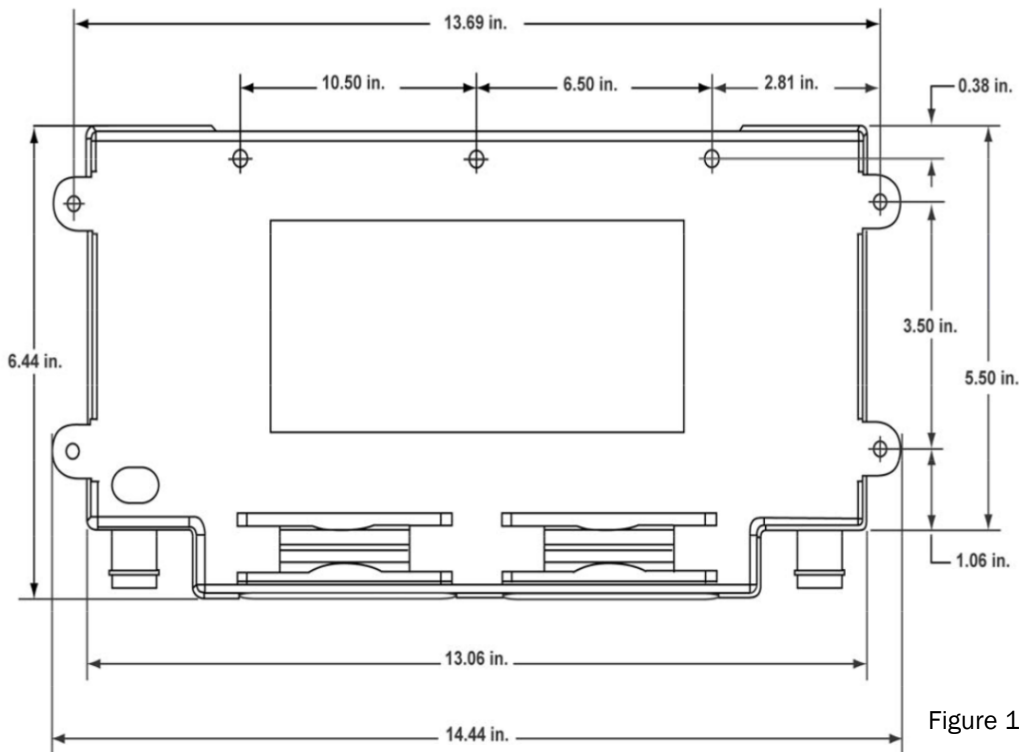

Figure 12

Mounting the Heat Exchangers

1. Cut out a 2.5"H x 10"W opening for each heat exchanger outlet and cold-air return register.
2. Mount each heat exchanger permanently into place. Reference figure 13 and figure 16 (next page.)
3. Install the hot-air outlet and cold-air return registers. Reference figure 13 below.

Please note that a return-air register may not be required, however, adequate return air must nonetheless be provided to the heat exchanger or you may experience diminished performance of the heat exchanger unit. The total cross-sectional area of the cold-air inlet must be at least equal to the cross-sectional area of the hot-air outlet to ensure optimal performance.

If the toe-kick areas are inadequate to house a heat exchanger for regular installation, a plenum assembly may be used on the heat exchanger, which can be used with a smaller vent as seen in figure 14. The plenum allows only the desired outlets to be opened by removing the metal insert on the vent.

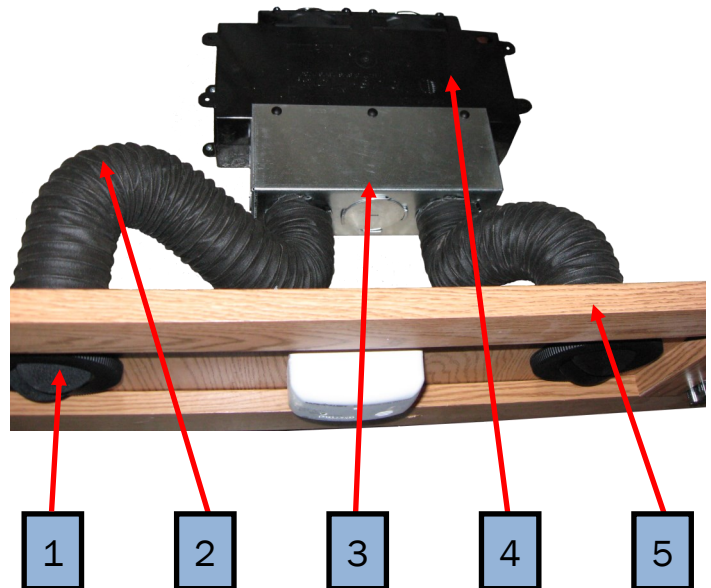

1. Hot air vent
2. Air ducting hose
3. Plenum
4. Cozy heat exchanger
5. Toe kick board

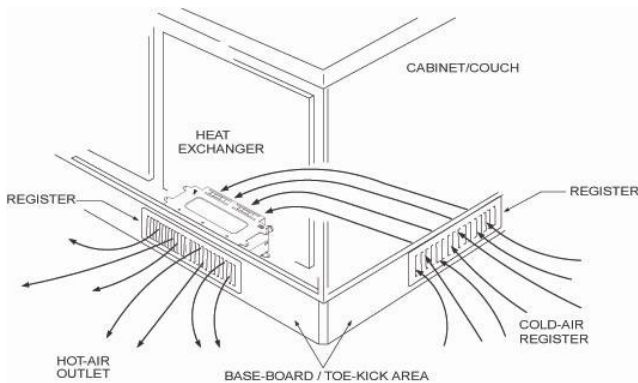

Figure 13

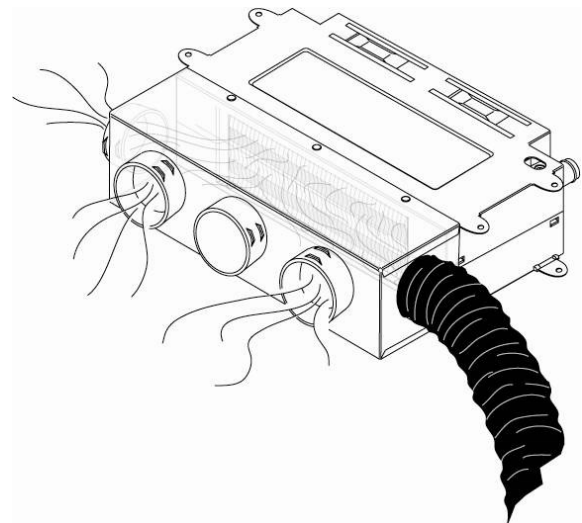

Figure 14

Heat Exchanger Locations and Clearances

Place the heat exchangers so that even heat distribution will be felt throughout the interior of the coach. Reference page 13.

NOTE: For single slide-out configurations, it is usually simplest to place a heat exchanger on the opposite side of the coach pointing towards the slide-out.

Place the heat exchangers where they will be accessible for potential maintenance. If used for bay heating, centralize and position a heat exchanger in the fresh water storage tank plumbing bay. To achieve best results, place the heat exchanger as close to the floor of the plumbing bay as possible. Reference figure 11, figure 13, and figure 15 and for mounting location information. Reference figure 16 for clearance information.

Boost Pump

If desired, a 6th Cozy Heat Exchanger may be added to the heating loop within your coach. Please note, however, that an additional boost pump is required to provide adequate fluid pressure to allow the 6th heat exchanger to operate as intended.

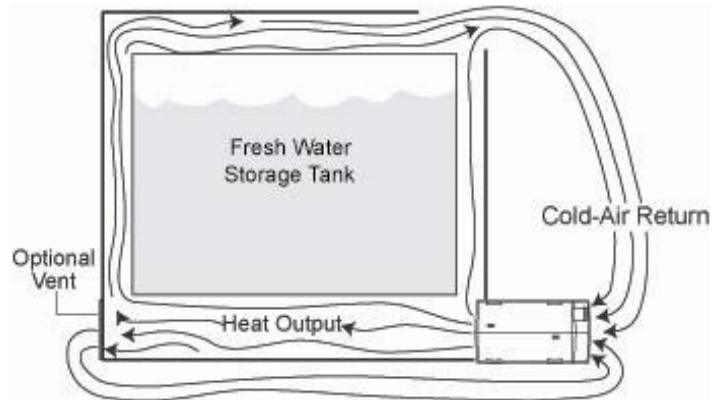

Figure 15

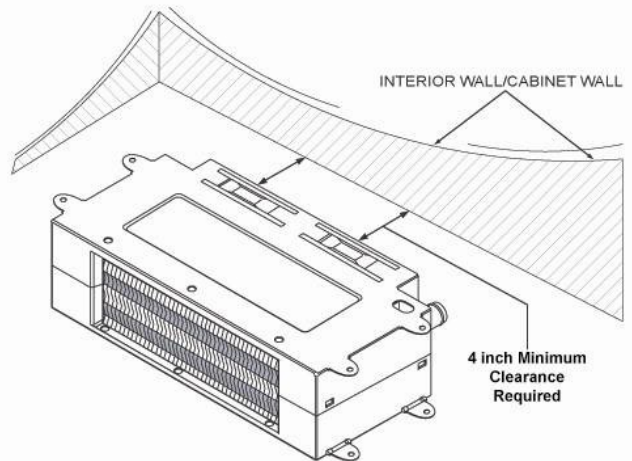
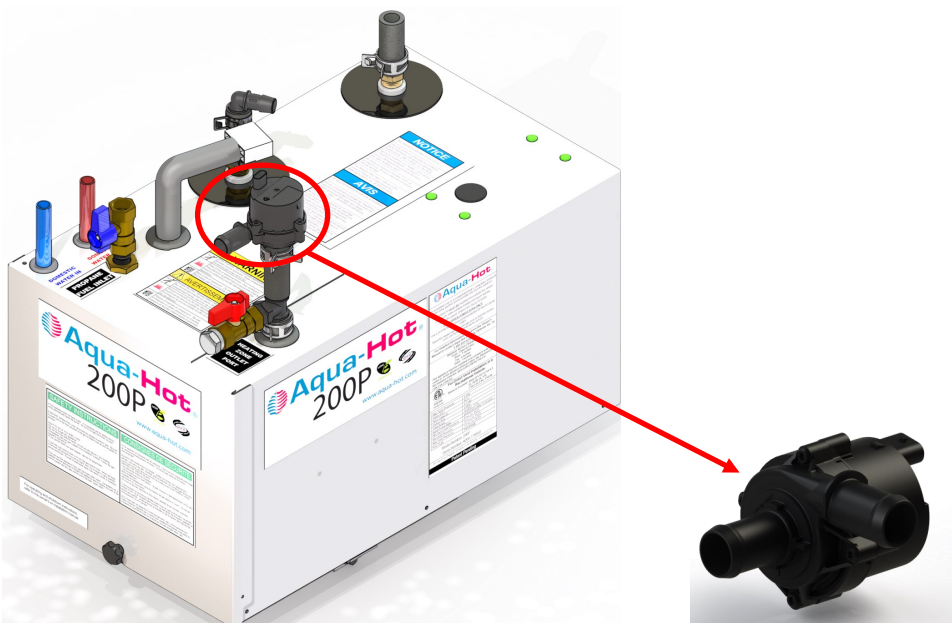

Figure 16



Wiring the Heat Exchangers

1. Wire all heat exchangers in a parallel circuit inside the coach (i.e. all heat exchangers share a common power wire and a common ground wire.) Reference Figure 18 on page 17.
2. Run the power wire from the last heat exchanger back to the eight-pin connector and plug it into pin #7.
3. Run the ground wire from the last heat exchanger back into the 8-pin connector and plug it into pin #8.
4. With the remaining heat exchangers, tap the power from each exchanger into the previously connected power wire that is running back to the 8-pin connector.
5. Repeat the above with the ground wire.
6. Reference figure 18.

Wiring for OEM RV-C or Multiplex Control Systems

When choosing a zone control for the heat exchangers, the following guidelines must be adhered to, or the Aqua-Hot will not function correctly in any mode of operation.

- Pin 6 must be supplied with +12V DC to provide power to the coolant circulation pump
- Pin 7 must be integrated into the OEM control of the zone
- Pin 7 will be +12V DC when there is a call for interior heat. This +12V DC current will drop when the Aqua-Hot senses domestic water flow

Diesel Harness Plug



Propane Harness Plug



Wire-insertion view shown

Figure 17

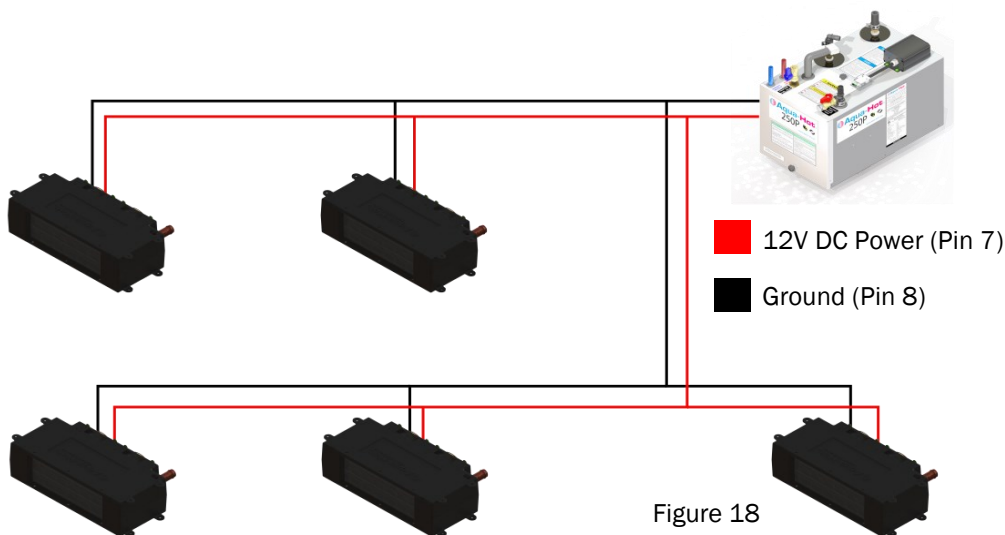

Plumbing the Hydronic Heating System

When plumbing the heat exchangers that will be used to heat the coach, the guidelines listed below are written as to support the operation of heat exchangers. Failing to adhere to these installation principles can hinder the operation of heat exchangers installed within the coach.

- All plumbing lines should be laid as flat as possible, and any extreme rises in height should be avoided to eliminate any potential air traps
- Use 5/8" I.D. (inside diameter) plumbing lines (SAW J20 type hose) for both heating loops. Use wide-sweeping elbows or "bend supports" whenever the plumbing lines may be susceptible to kinking (90° bends.)
- When exceeding 5 heat exchangers, a boost pump must be installed in the coolant line to provide adequate pressure to ensure that coolant is distributed throughout the heating loop
- Plumbing lines should be run in areas where there is no reasonable possibility that they can be pinched off, or damaged under normal operating conditions
- Secure all lines where necessary and apply protective shielding in areas where chafing may occur
- Rubber coated/closed-type clamps are recommended when securing the plumbing lines
- Inlet and outlet plumbing lines can be installed with a straight fitting or an elbow fitting

Instructions

1. Layout the plumbing lines for all heat exchangers
2. Label each line and designate as an inlet or an outlet line
3. Connect and clamp the outlet line from the heater to the lowest port (inlet port)
4. Connect and clamp a line from the first heat exchanger's highest port, and connect the other end to the next heat exchanger's lowest point
5. Connect each additional heat exchanger in the same arrangement (in through the bottom, out through the top.)
6. Connect and clamp the inlet line from the heater to the highest port on the last heat exchanger to complete the heating loop.

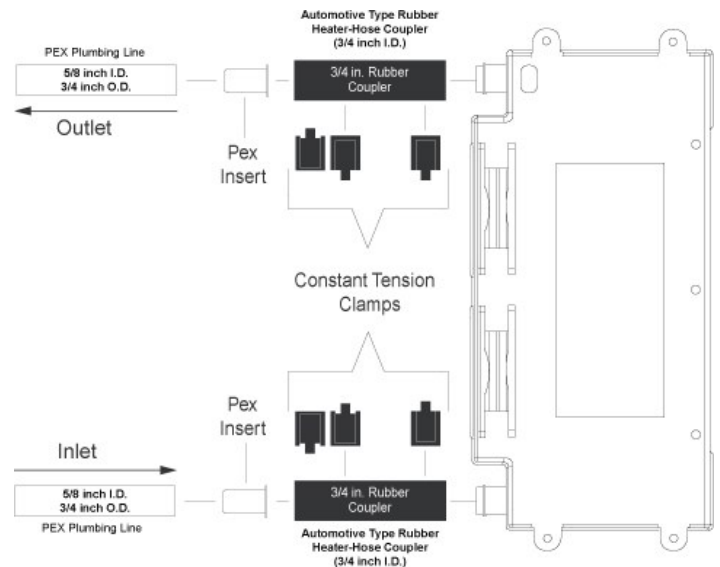

Figure 19

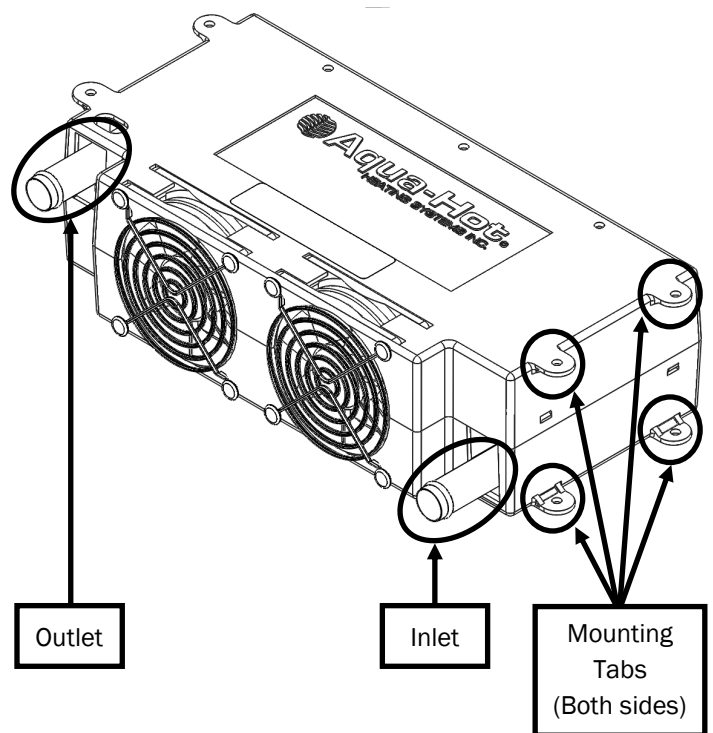

Figure 20



NOTE: The AC relay enclosure has been suppressed in this view to allow an unobstructed view of constant tension clamps.

Figure 21



Figure 22

Domestic Water System Requirements

Reference A119.2/NFPA 501C Standard on Recreational Vehicles, 1993 Edition for domestic water systems.

The Aqua-Hot is equipped with a pressure-relief valve, which releases the excessive pressure in the domestic water system, if necessary. A tempering valve is also needed to regulate the temperature of the hot water.

To ensure consistent water temperature, hot water fixtures within the coach shall be regulated to a maximum of 1.5 gallons/minute.

Domestic Water System Plumbing

1. Connect a domestic water plumbing line from the domestic water demand pump or water manifold to the cold water inlet port (blue PEX tube) on the Aqua-Hot.
2. Connect a domestic water plumbing line from the Aqua-Hot's hot water outlet port (red PEX tube) to the hot water system's distribution lines or manifold.

NOTICE

Aqua-Hot systems contain copper tubing and are not compatible with prolonged exposure to sodium hypochlorite (bleach or liquid bleach.) Using products containing bleach, including water refreshers may cause corrosion of the domestic water coil, resulting in a catastrophic failure of the Aqua-Hot system by creating leaks that cannot be repaired. This damage is not covered by the Aqua-Hot warranty.

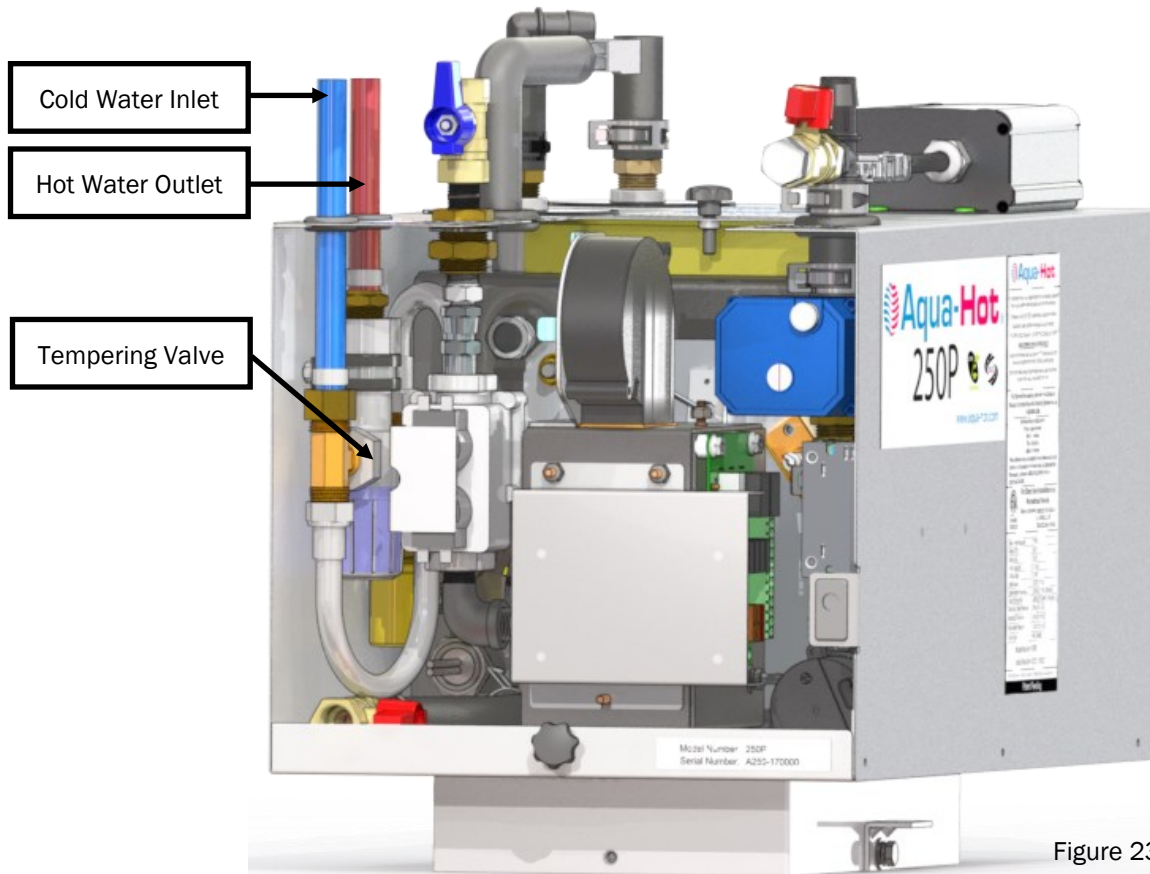

Figure 23

Switch Panel Location

Select a location in the interior of the coach that allows for easy operator access. Mounting plate dimensions are included below.

All electric installations, systems, and equipment shall comply with Article 551, Parts I and III through VI of NFPA 70, as well as the regulation of authorities having jurisdiction and CSA standard B139.

Switch Panel Mounting

1. Cut out a 3.75" W x 1.25" H opening for the switch panel plate.
2. Once the switch panel has been completely wired, permanently mount the switch panel in place.
3. Move both switches to the OFF position by pressing them in a downward motion.

Switch Panel Wiring

It is recommended that the wire colors illustrated in Appendices A, B, and C be used when installing the switch panels. This will ensure installation consistency, differentiate between the separate switches, and assist service personnel with troubleshooting. Reference ANSI/RVIA-LV for proper wire gauge sizing.

NOTE: Be sure to attach "Jumper Wires" where necessary. Reference figure 25 and 26.

1. Run 16-gauge wires from the switch panel to the eight-way connector to the Aqua-Hot
2. Strip and crimp insulated female terminals onto each wire at the switch panel location
3. Connect all switch wires to the appropriate switch connections as illustrated in figure 25 and figure. 26 Reference Appendices A, B, and C for additional wiring information.
4. Run the wires from the switch to Pins #3 and #4 on the eight-way connector at the Aqua-Hot

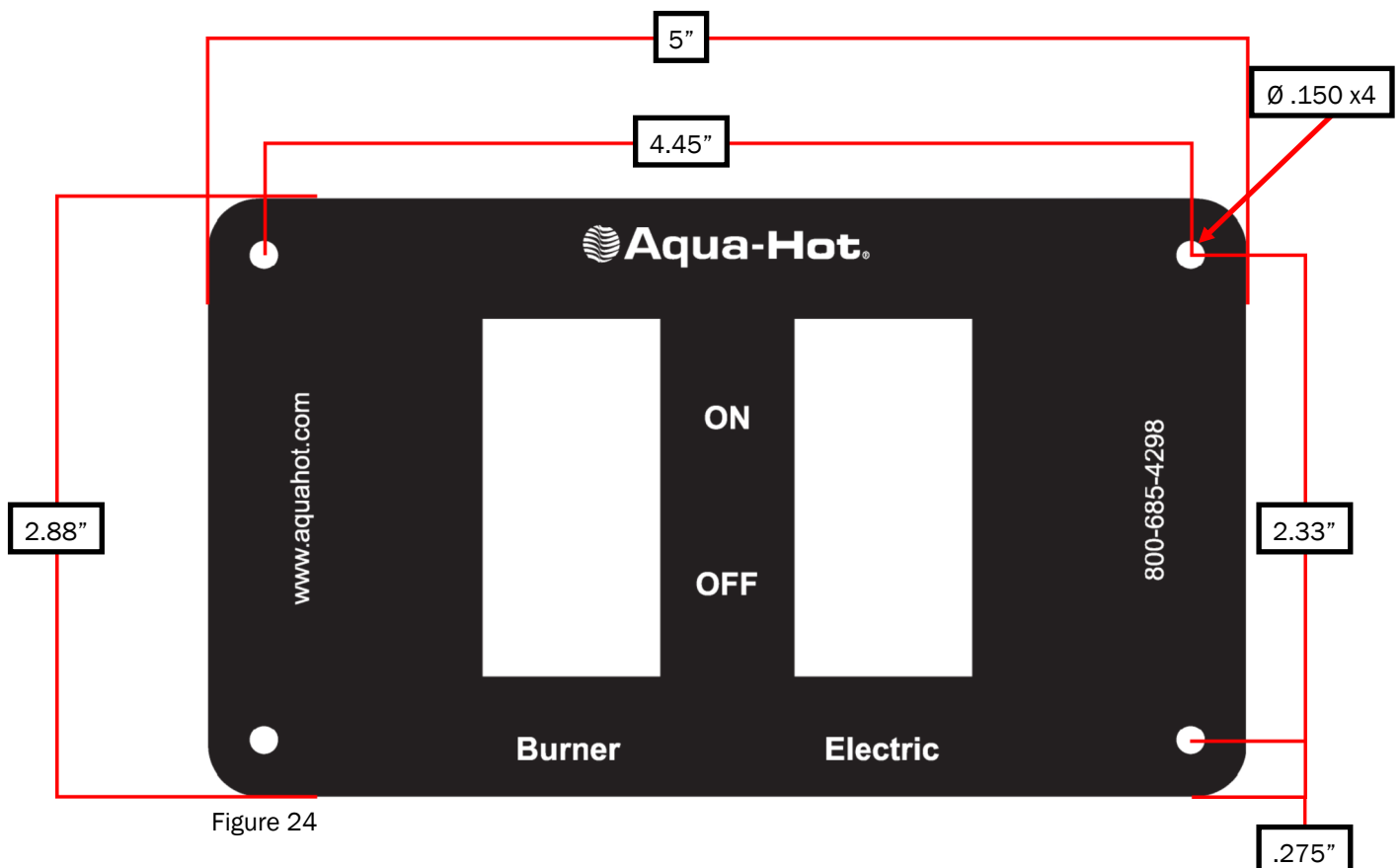

Figure 24

NOTE: The electric element switch must possess a jumper wire between pin 4 and pin 10 as depicted on this page.

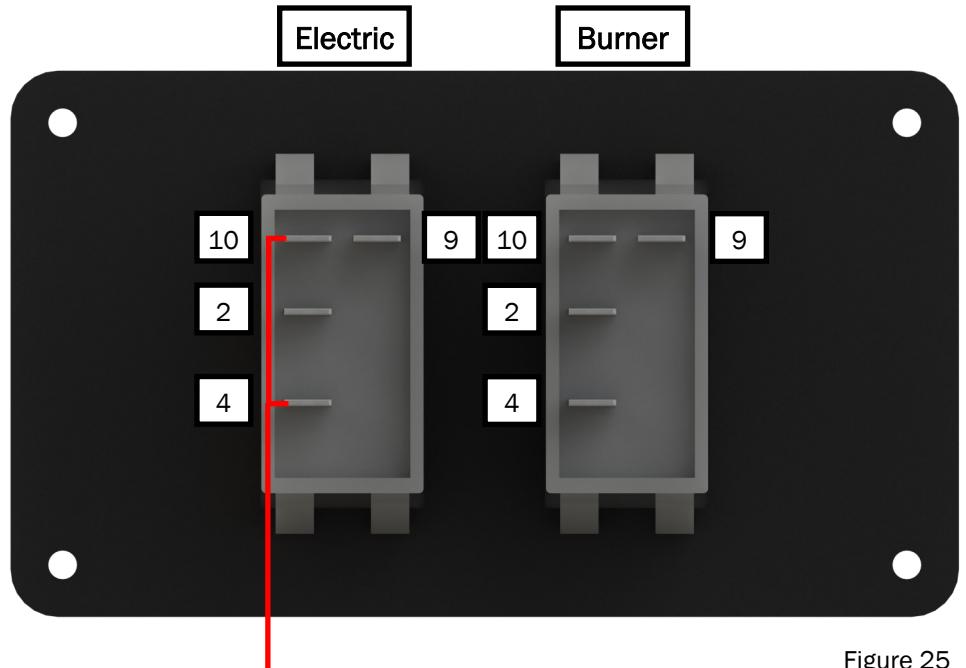

Figure 25

| AC Electric Switch | 12-Pin MATE-N-LOCK | Burner Switch | 12-Pin MATE-N-LOCK |
|--------------------|--------------------|---------------|--------------------|
| Pin 4 | Pin 9 | Pin 4 | Pin 4 |
| Pin 2 | Pin 10 | Pin 2 | Pin 5 |
| Pin 9 | Chassis Ground | Pin 9 | Chassis Ground |

NOTE: The AC control circuit connections have been integrated into the 12-Pin Mate-N-Lock receptacle, differing from the 250P.

Receptacle Housing Information

Mfg: TE Connectivity
 Part No: 1-480709-0
 Common Name: Mate-N-Lock



Wire Insertion View Shown

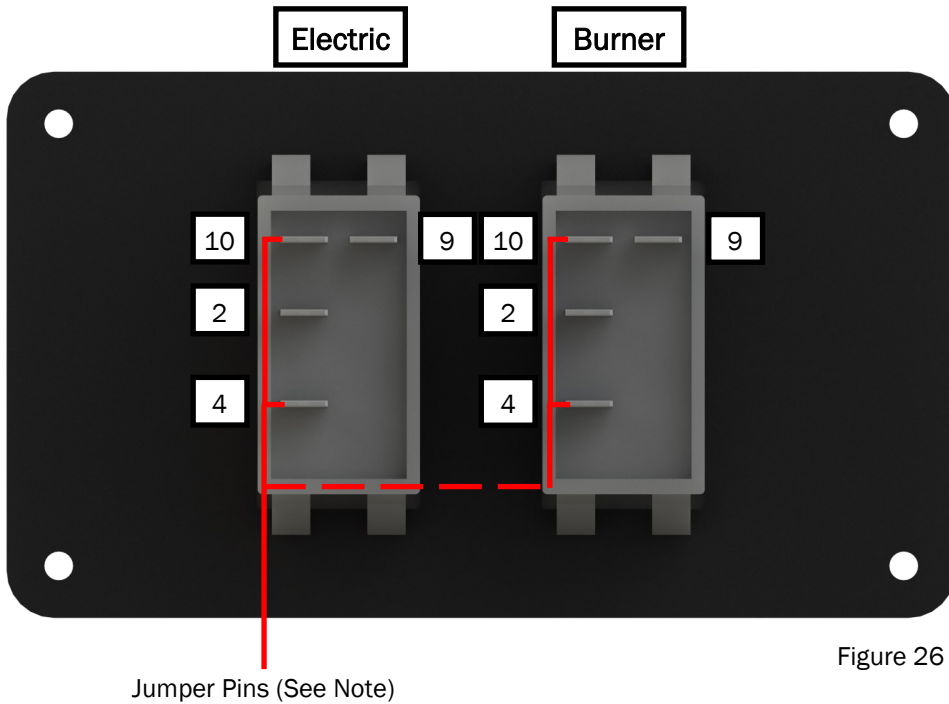

NOTE: The burner and electric element switches must possess a jumper wire between pin 4 and pin 10 as depicted on this page.

Figure 26

Jumper Pins (See Note)

WARNING

DO NOT INSTALL JUMPER WIRES ACROSS THE SWITCHES IN THE SWITCH PANEL. JUMPER WIRES ARE ONLY TO BE INSTALLED BETWEEN PIN 4 AND PIN 10 ON EACH SWITCH. FAILURE TO ADHERE TO THIS GUIDELINE MAY RESULT IN DAMAGE TO YOUR AQUA-HOT AND/OR COACH.

| AC Electric Switch | AC Control Switch Plug |
|--------------------|------------------------|
| Pin 4 | Pin 1 |
| Pin 2 | Pin 2 |
| Pin 9 | Chassis Ground |
| Burner Switch | 8-Pin Harness Plug |
| Pin 4 | Pin 3 |
| Pin 2 | Pin 4 |
| Pin 9 | Chassis Ground |

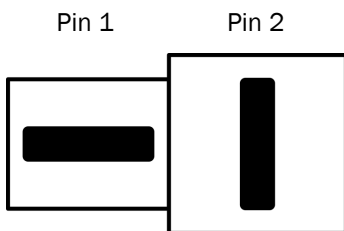

2-pin AC Control Switch Plug

Manufacturer: TE Connectivity
 Part No: 180908
 Common Name: Fastin-Faston Series

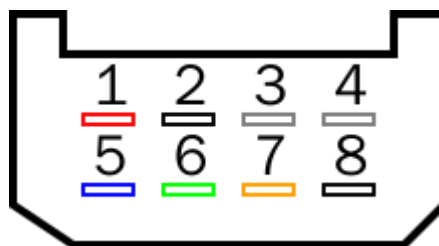

8-pin Harness Plug

Manufacturer: TE Connectivity
 Part No: 163007
 Common name: 8-Way Fastin Receptacle

Propane Fuel System

The following section outlines requirements for propane fuel delivery to the Aqua-Hot unit. Please read and adhere to all of the outlined requirements to ensure best performance of the Aqua-Hot unit.

 **WARNING**

Use caution when working on or near the propane gas systems.

- Do not smoke or use an open flame near the propane gas system
- Do not use an open flame to examine for leaks
- To avoid possible propane gas leaks, always use two wrenches to tighten or loosen the gas supply line connectors
- Leaking propane can ignite or explode and result in serious personal injury or death
- Ensure that all tubing and fitting obey all local, state, and national codes regarding size and type
- Ensure that the material used for the propane supply line obey both the current ANSI 119.2 (NFPA1192) AND CSA Z240 Standards on Recreational Vehicles

The fuel delivery system must meet the requirements of “NFPA 1192 Standards of Recreational Vehicles.” For pipe sizing, use NFPA 54/ANSI Z223.1, which ensures the complete vehicle gas demand/pipe sizing is considered during the layout of the fuel system. For the 200P/250P use an input rating of 70,000btu/hr in calculating fuel pipe “inside diameter” when other propane appliances are installed in the same propane power supply system.

The Aqua-Hot 200P and 250P must be isolated from gas supply by closing the manual shut off valve during any pressure testing of the gas supply piping system.

- Run an appropriate size line of an approved material (per NFPA standard) from the propane manifold to the propane ball-valve installed on the Aqua-Hot’s propane inlet port
- Tighten both connections thoroughly using two wrenches to ensure that no leaks occur

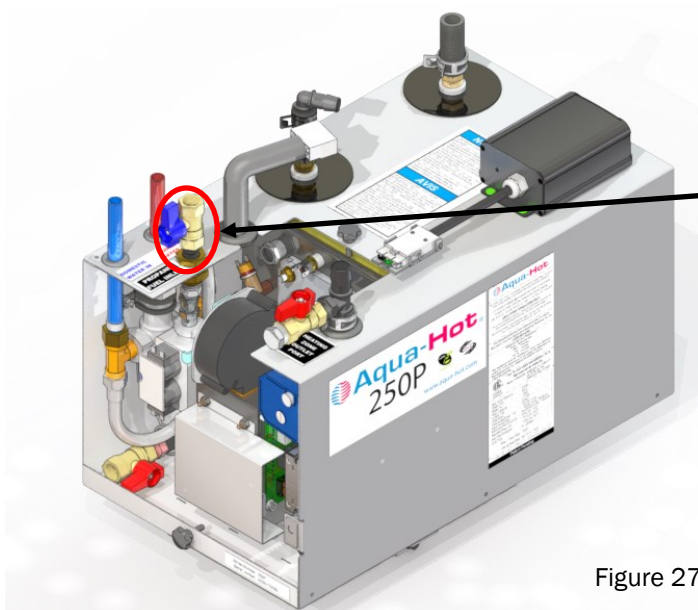
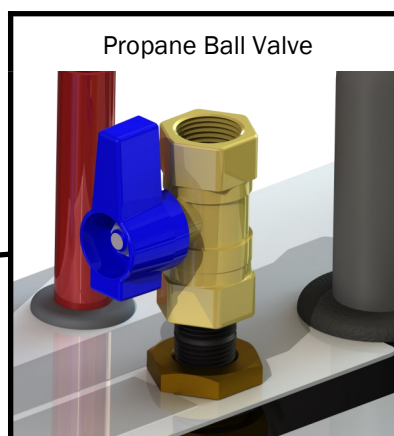

Figure 27

Diesel Fuel System

The following section will outline details of installing the diesel fuel delivery system to the Aqua-Hot 250D. These guidelines and instructions are to be followed exactly. Failure to follow instructions herein can cause damage to the Aqua-Hot unit, coach, and may cause serious personal injury.

Fuel Filter

A 10 micron diesel fuel filter must be installed at the diesel fuel source at all times during the operation of the Aqua-Hot 250D. This fuel filter ensures clean fuel is delivered to the fuel nozzle at all times. Ensure that the fuel filter assembly is mounted in an accessible area, as the fuel filter needs to be changed regularly to ensure optimal operation of the 250D.

Fuel System Requirements

- The diesel fuel supply should be drawn directly from the vehicle's main fuel tank if applicable
- The fuel tank should be equipped with a dedicated fuel pick-up pipe (outlet port and inlet port.)

- Use 1/4" I.D. (inner diameter) fuel lines
- The combined length of the supply and return fuel lines should not exceed 50 feet in total length.
- All fuel lines should be laid as flat as possible, and any extreme rises in height should be avoided to eliminate any potential air traps
- Run the fuel lines in areas where they cannot be pinched, kinked, or otherwise damaged during normal operation
- Run the fuel tank outlet fuel line past the fuel filter in preparation for step 5
- Secure all fuel lines where necessary, and apply protective shielding in areas where chafing may occur
- All fuel-fitting hardware (at the vehicle fuel tank, fuel filter, and Aqua-Hot parts) must be 1/4" NPT or greater with a barbed fitting. Fuel fittings that are less than 1/4" NPT may restrict fuel flow, thereby compromising the diesel-burner's performance
- The maximum allowable suction height is 7 feet
- Maximum allowable head pressure is ten feet

NOTE: If an auxiliary fuel tank is required, be sure to consult the ANSI/NFPA 1192 handbook concerning heating systems' diesel fuel specifications, and fuel distribution specifications.

NOTE: Ensure that the fuel filter is installed with correct flow in mind as demonstrated by figure 29.

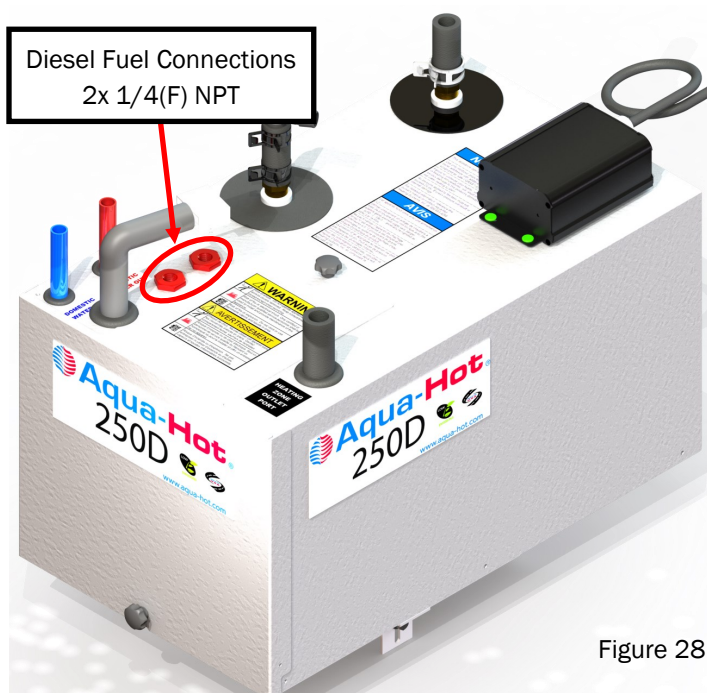

Figure 28

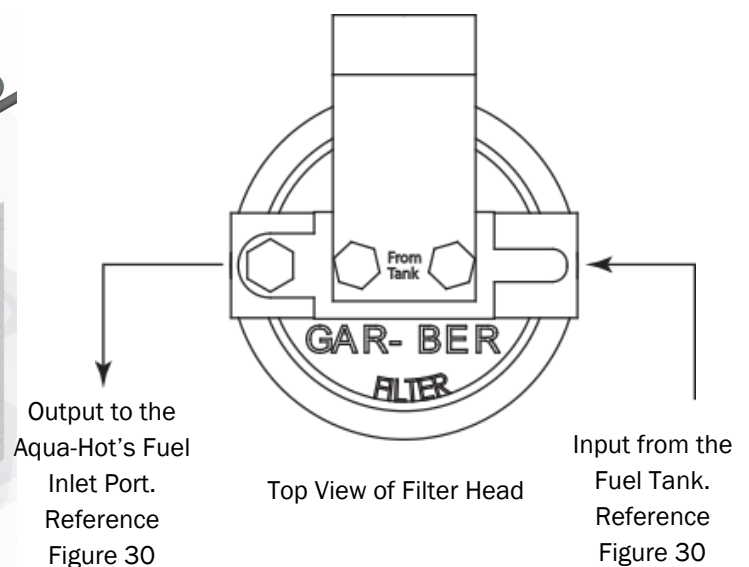

Figure 29

Installation Instructions

Fuel System Installation

1. Run two 1/4" fuel lines from the fuel tank inlet and outlet ports to the Aqua-Hot. Label both fuel lines indicating whether the line is incoming, or outgoing.
2. Install and tighten the fuel fittings onto the two ports of the fuel filter. Reference figure 29 for the correct connection configuration.
3. Install and tighten the appropriate fuel fittings onto the Aqua-Hot's fuel ports. Reference figure 28.
4. Connect the Aqua-Hot's fuel lines to the fuel tank.
5. Cut the fuel line at the fuel filter mounting location and connect the fuel lines as illustrated in figure 29.

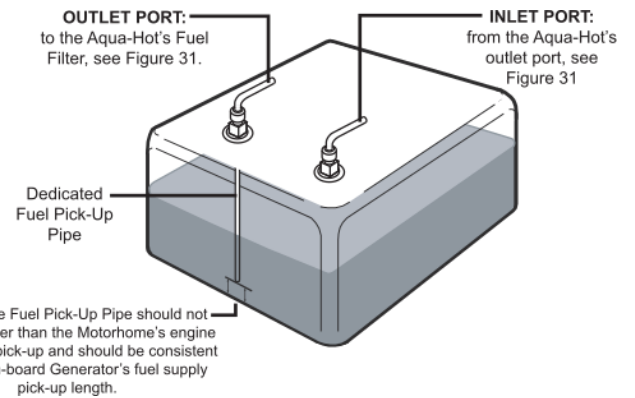

Figure 30

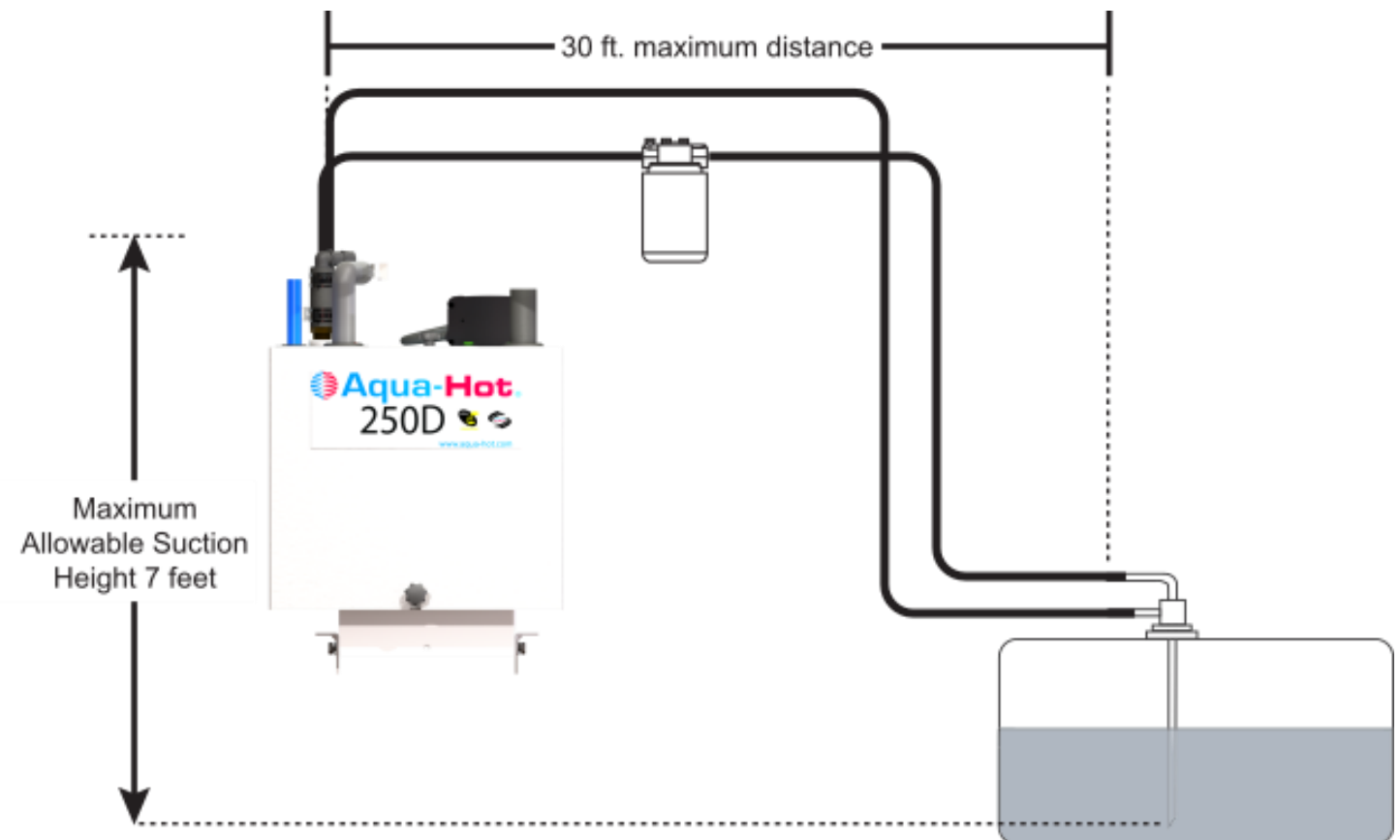

Figure 31

Exhaust System

This section outlines in detail the specifications and requirements for installing the diesel fuel exhaust system. These requirements must be adhered to in order to create optimal operating conditions for the Aqua-Hot unit.



WARNING

Exhaust from the Aqua-Hot is very HOT and must be kept away from any heat sensitive materials. Failure to do so may result in a fire.

Exhaust System Requirements

- DO NOT direct exhaust downward as fire may result when parked in dry grassy areas
- Exhaust must not terminate beneath the vehicle, or beneath an openable window or vent
- DO NOT terminate the exhaust pipe within the awning area of the coach, if applicable
- Ensure that the exhaust is shunted away from slide-out areas
- Angle the exhaust pipe away from, and towards the back of the vehicle so that the exhaust naturally moves away while the vehicle is in motion



CAUTION

All Aqua-Hot exhaust system installations MUST utilize the two black pipe nipples and the black pipe elbow, which are supplied separately from the heating system in the configuration best suited for the particular recreational vehicle application. Failure to conform to this standard could create a hazardous situation and will void the Aqua-Hot's ETL product listing

- Use standard 2" automotive exhaust pipe and avoid any bends if possible
- DO NOT use galvanized pipe or fittings, only black-iron pipe fittings are permitted for use

Refer to "Internal Combustion Engine Exhaust and

Vehicle Wall Openings" in RVIA's ANSI/NFPA 1192 Handbook for Recreational Vehicle Standards as well as the National Fire Protection Associations (NFPA) 1192 Standard on Recreational Vehicles for additional information.

| | |
|--------------------|---|
| <p>LDE-200-815</p> | <h3>CAUTION</h3> |
| | <p>Risk of Fire or Equipment Damage</p> <p>Hot exhaust tube can ignite flammable materials.</p> <p>Maintain 2-inch/50.8mm clearances from any heat sensitive material, including fuel lines, wiring and hoses.</p> |

Should the particular application require modification of exhaust pipe, please contact the Aqua-Hot Heating Systems Product Application Department at +1 (800) 685-4298 for assistance.

Installing the Exhaust System

Aqua-Hot separately supplies a kit that contains two 1.5" NPT black pipe nipples, one is 3" in length, the other is 4" in length. These three exhaust system components must be utilized with all Aqua-Hot product installations. Be sure to reference figure 35 to determine which exhaust nipple should be connected directly to the Aqua-Hot's exhaust port (i.e., the 3" or 4" black pipe nipple.) Also an exhaust tip is included with the 200P and 250P that must be installed on the end of the exhaust pipe in order to remain in compliance with ETL. Reference figure 34.

1. Run the exhaust pipe to the driver's side or the back of the vehicle to ensure that the exhaust fumes cannot enter into the passenger compartment. Be sure to keep the exhaust away from the slide-out areas
2. Be sure to secure the end of the exhaust pipe to the vehicle with the proper exhaust hanger/support hardware
3. For 200P/250P models, slide the exhaust tip (included with the exhaust kit) over the end of the exhaust pipe, being sure to leave a required clearance of at least 1" between the band on the top and the end of the exhaust pipe. Mark where the holes should be drilled to allow for a #8 sheet metal screw, 3/8" in length to securely mount the exhaust tip to the exhaust pipe. Drill holes in the pipe and mount the exhaust tip with a self-tapping screw. The exhaust tip prevents excessive air movement up the exhaust pipe, preventing the propane burner from extinguishing in windy conditions.

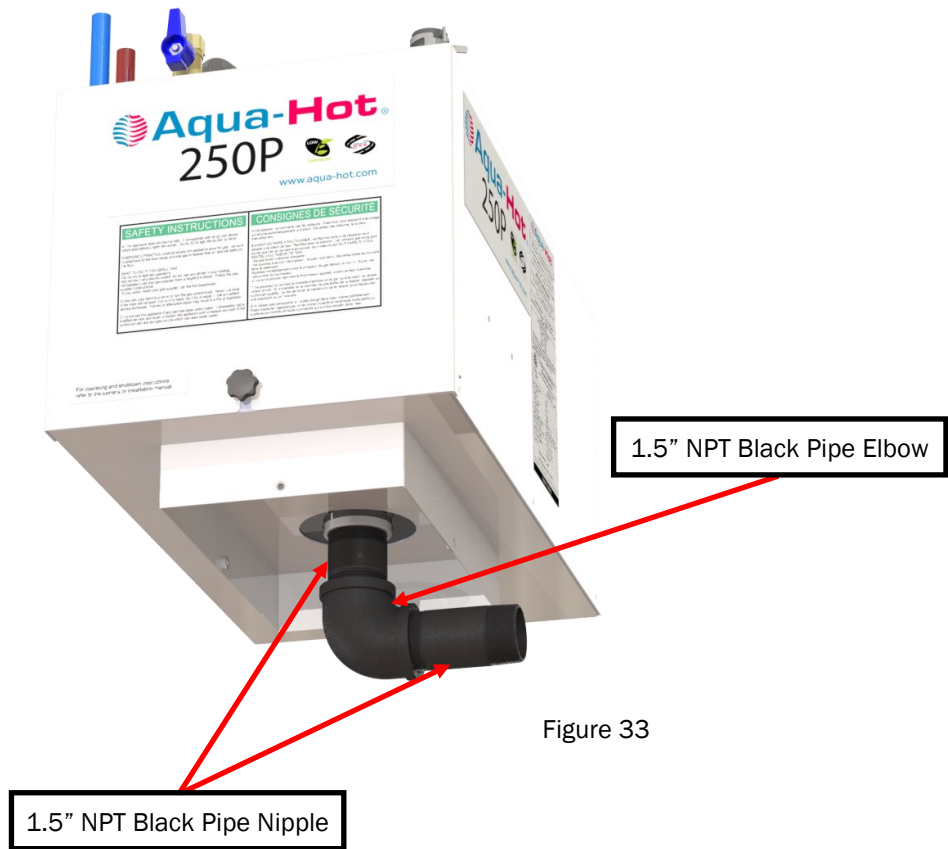
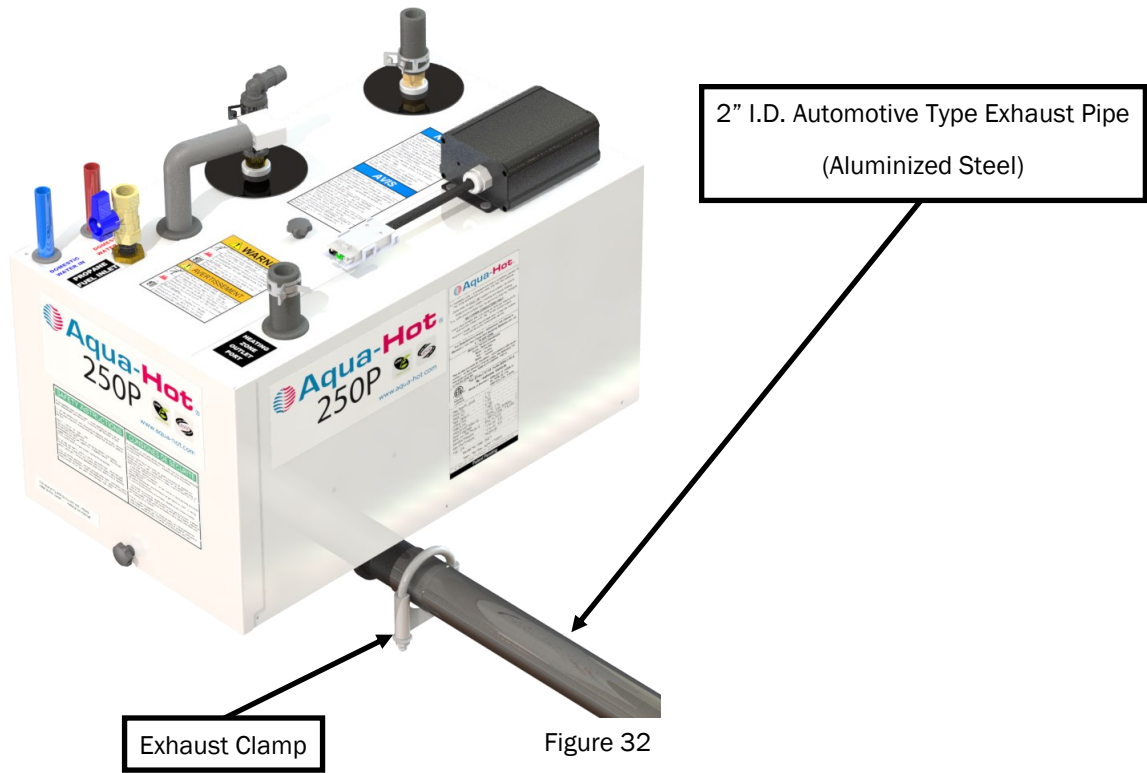

| | |
|--|--|
|  <p>LDE-200-815</p> | <p>CAUTION</p> <p>Risk of Fire or Equipment Damage</p> <p>Hot exhaust tube can ignite flammable materials.</p> <p>Maintain 2-inch/50.8mm clearances from any heat sensitive material, including fuel lines, wiring and hoses.</p> |
|  <p>LDE-200-805</p> | <p>WARNING</p> <p>Heater Exhaust Produces Carbon Monoxide (CO₂)</p> <p>Carbon Monoxide (CO₂) can cause headaches, brain damage or death.</p> <p>DO NOT operate heater within a closed interior area. Confirm heater switch is in OFF position when vehicle is in an enclosed space.</p> |

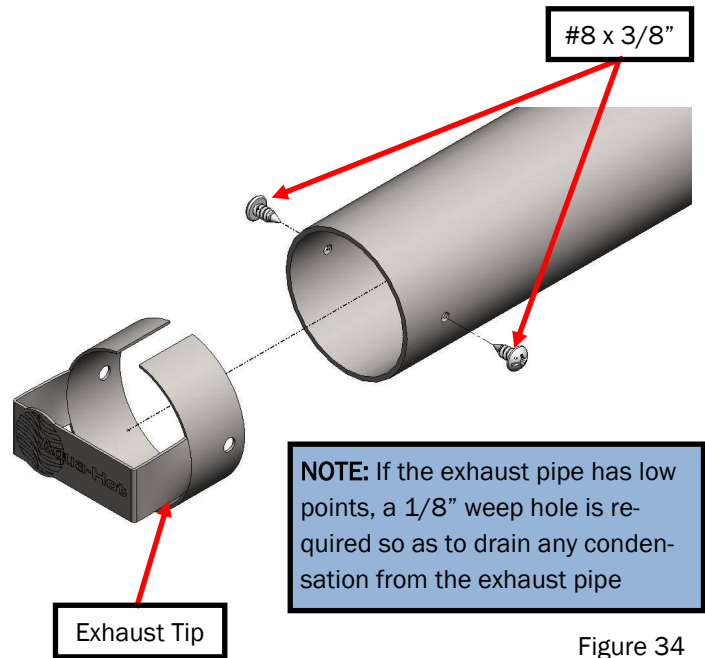

Figure 34

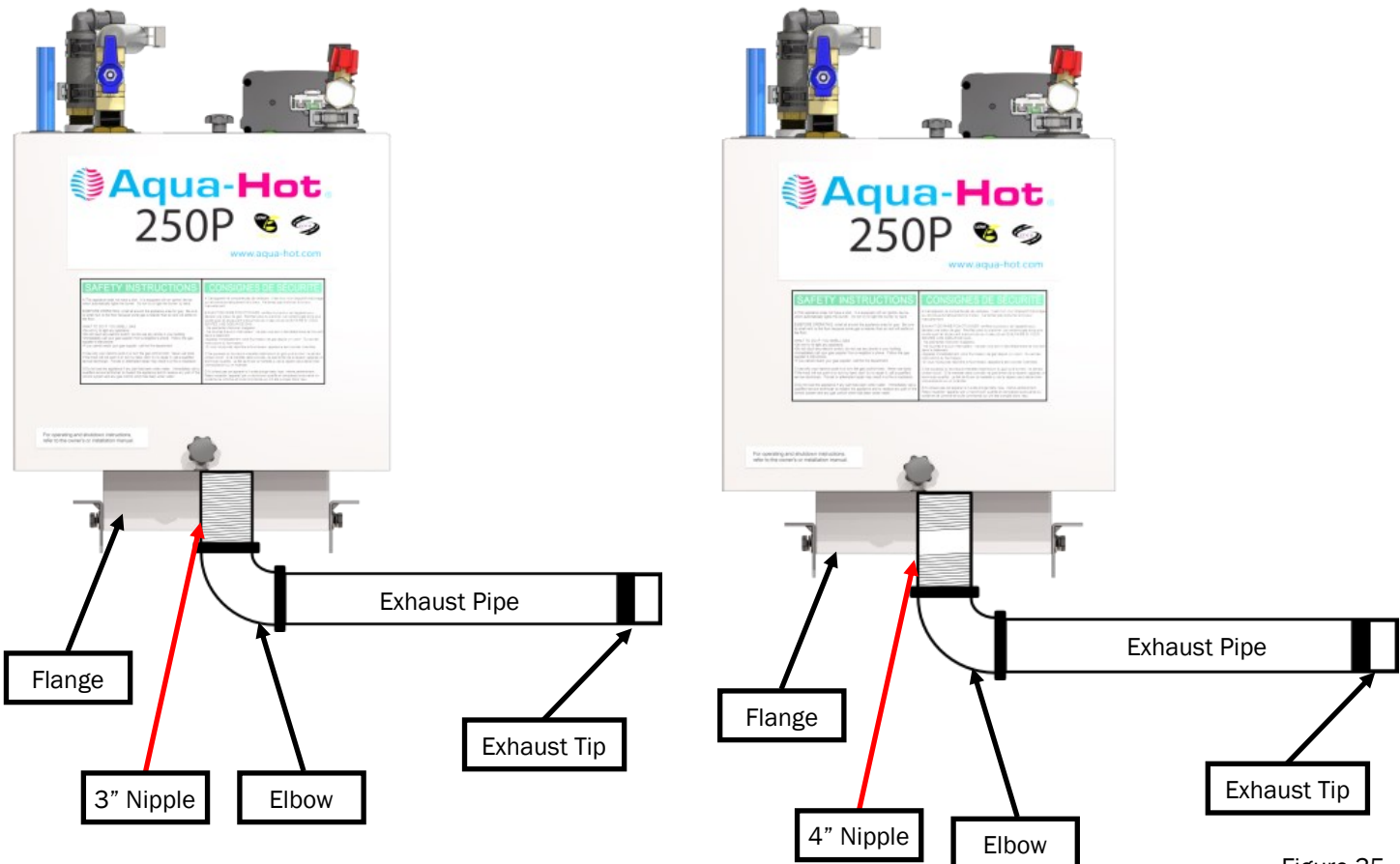

Figure 35

NOTE: Exhaust must terminate at least 3 ft. from any coach openings (e.g. doors and windows.)

200 Series Pin-Out Information

The following section serves to provide electrical information particularly pertaining to pin-out configurations to assist in correctly wiring the coach-side electrical connections.

The Diesel and Propane wiring harnesses differ in several key aspects, most notably the mating connectors are substantially different.

Pins 1 through 8 will be the same on both the diesel, and propane harness plugs.



Diesel Harness Plug
Wire insertion view shown



Propane Harness Plug
Wire insertion view shown

| Pin | Coach Side | Aqua-Hot Side | Wire Color |
|-----|---|---|------------|
| 1 | 12V DC (20A Fused) from coach | System Power | Red |
| 2 | Coach ground | System Ground | Black |
| 3 | Return Signal from Burner Switch | Main System Relay (#1) | White |
| 4 | Output to Burner Switch | System Power | White |
| 5 | Output to Room Thermostat | Power from Main System Relay | Blue |
| 6 | Return from Room Thermostat | Interior Heat Relay (#2) | Green |
| 7 | Output to Heat Exchangers | Signal to valve and interior heat relay (#2 & #3) | Orange |
| 8 | Return from Heat Exchangers | System Ground | Black |
| 9 | Electric Switch Return Signal (250D Only) | Electric On Signal | White |
| 10 | Electric Switch Power (250D Only) | System Power | Blue |
| 11 | Burner Indicator Light (250D Only) | System Power | Green |
| 12 | Optional Boost Pump (250D Only) | Signal to valve and interior heat relay (#2 & #3) | Orange |



Connecting 12V DC Power to the 200P/250P



DO NOT connect 12V DC power to the Aqua-Hot if the vehicle requires welding. Electrical welding will cause serious, and irreversible damage to the Aqua-Hot.

Before connecting power to the Aqua-Hot, it is imperative that the proper wire gauge be determined and utilized. Reference ANSI/RVIA-LV for proper wire gauge sizing. Please note that under full-load conditions, the Aqua-Hot can draw as much 10 amperes of DC current.

Be sure to protect against accidental shorting (i.e. chassis shorting) by incorporating a 10A rate in-line fuse into the power wire at the battery location. The following table calls out the proper connector and terminals needed to interface with the Aqua-Hot.

| Table 1: 8-Way Female Connector and Terminals | | |
|---|-----------------------------|---|
| Connector/ Terminal | Manufacturer Part Number | Part Image |
| TE Connectivity 8-Way "Fastin" Receptacle Housing | 163007 |  |
| TE Connectivity 12-16AWG 0.25 "Fastin" Receptacle | 50253-2 |  |
| TE Connectivity 14-18AWG 0.25 "Fastin" Receptacle | 42100-2 |  |

Supplying Power to the 8-way Connector

- Run two properly gauged wires (Red for + and Black for -) from the main power disconnect to the 8-way connector located atop the Aqua-Hot.
 - The Red + wire must be fused with a 25A fuse to protect the heater from over-current
- Crimp the appropriate terminals called out in Table 1 to the wires. Perform a pull test to ensure that the wires do not come out of the terminals.
- Insert the power wire (+) into Pin #1 of the 8-way receptacle housing connector.
- Insert the ground wire (-) to Pin #2 of the 8-way receptacle.

Wiring the Coach Thermostat

- Run two properly gauged wires (red for +, black for -) from the coach thermostat to the 8-way pin connector located atop the Aqua-Hot.
- Crimp the appropriate terminals called out in Table 1 to the correct wires
- Perform a pull test to ensure that the wires do not become removed from the wires
- Insert the positive signal wire from the thermostat to Pin #5 of the 8-way receptacle
- Insert the thermostat ground signal wire into Pin #6 on the 8-way receptacle

NOTE: For wiring cozy heat exchangers, reference page 17.

Connecting 12V DC Power to the 250D



CAUTION

DO NOT connect 12V DC power to the Aqua-Hot if the vehicle requires welding. Electrical welding will cause serious, and irreversible damage to the Aqua-Hot.

Before connecting power to the Aqua-Hot, it is imperative that the proper wire gauge be determined and utilized. Reference ANSI/RVIA-LV for proper wire gauge sizing. Please note that under full-load conditions, the Aqua-Hot can draw as much 10 amperes of DC current.

Be sure to protect against accidental shorting (i.e. chassis shorting) by incorporating a 10A rate in-line fuse into the power wire at the battery location. The following table calls out the proper connector and terminals needed to interface with the Aqua-Hot.

Table 2: 12-Pin Mate-N-Lock Connector and Terminals

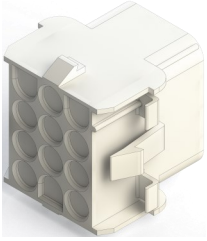
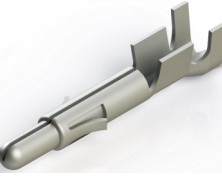
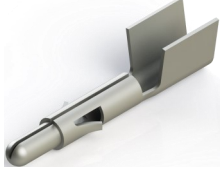
| Connector/ Terminal | Manufacturer Part Number | Part Image |
|---|-----------------------------|---|
| TE Connectivity Universal "MATE-N-LOCK" | 1-480709-0 |  |
| TE Connectivity 20-14AWG UMNL | 350547-1 |  |
| TE Connectivity 10-12AWG UMNL | 640309-3 |  |

Supplying Power to the 12-Pin Mate-N-Lock

- Run two properly gauged wires (Red for +, Black for -) from the main power disconnect to the 12-Pin Mate-N-Lock connector located atop the Aqua-Hot
 - The Red + wire must be fused with a 25A fuse to protect the Aqua-Hot from an over-current condition
- Crimp the appropriate terminals called out in Table 2 to the wires. Perform a pull test to ensure that the wires do not come out of the terminals.
- Insert the power wire (+) into Pin #1 of the 12-Pin Mate-N-Lock receptacle housing.
- Insert the ground wire (-) to Pin #2 of the 12-Pin Mate-N-Lock receptacle housing.

Wiring the Coach Thermostat

- Run two properly gauged wires (red for +, black for -) from the coach thermostat to the appropriate terminals as annotated on page 23.
- Crimp the appropriate terminals called out in Table 2 to their corresponding wires
- Perform a pull test to ensure that the wires do not become removed from the terminals
- Insert the positive signal wire into Pin #6 of the 12-Pin receptacle housing
- Insert the thermostat ground signal wire into Pin #8 of the 12-Pin receptacle housing

NOTE: For wiring cozy heat exchangers, reference page 17.

Connecting 120V AC Power

WARNING

DO NOT activate the burner until anti-freeze and water heating solution has been added to the boiler tank and the heating system has been completely bled of air. Operating the Aqua-Hot without the anti-freeze and water solution could cause serious damage to the Aqua-Hot boiler tank.

The following section explains in detail how to wire, and connect the Aqua-Hot into your coach-side 120V AC power system. Included are examples of plugs and connections, as well as mating part numbers, and location call-outs.

1. Route three 120V AC power source wires to the Aqua-Hot heater
2. Using one of the Molex connectors described below, crimp the 120V AC power source wire into the connector
3. Plug the newly crimped 120V AC Molex connection into the mating Molex connection on the Aqua-Hot

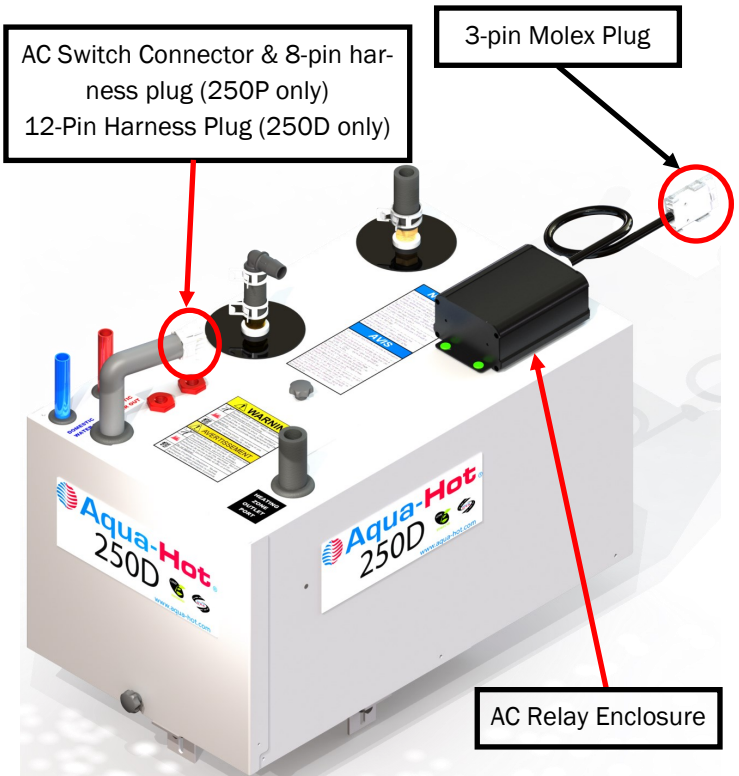
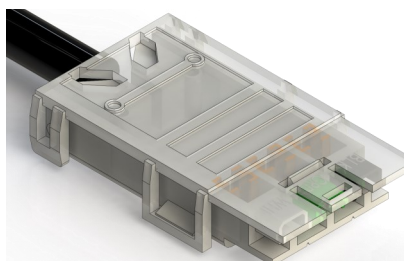
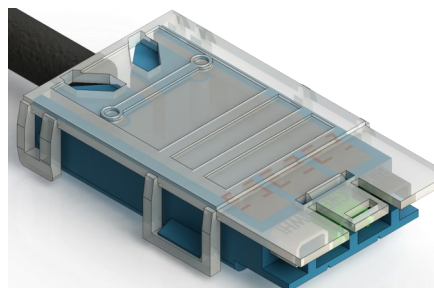

Figure 36

| Self Contained Power Connector – 2-Circuit for Solid Wire | | |
|--|-------------|---------------|
| Wire Range | Part Number | Housing Color |
| 12AWG-14AWG | 19045-1000 | White |
| Self Contained Power Connector – 2-Circuit for Stranded Wire | | |
| 14-AWG-16AWG | 19403-1011 | Blue |
| 12AWG | 19403-1010 | Yellow |



Molex 19403-1000



Molex 19403-1011

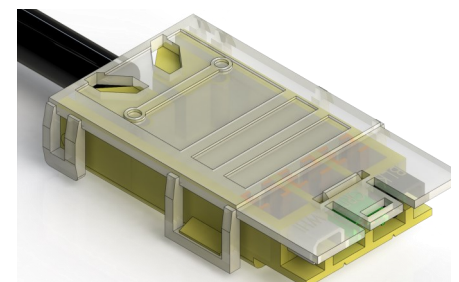

Molex 19045-1010

Purging the Hydronic Heating System

In order to provide the best freeze protection, boil-over protection, anti-corrosion, and rust prevention, a 50/50 mixture of “GRAS” approved propylene-glycol based antifreeze and distilled or de-ionized water is recommended.

Be sure to use a “GRAS” boiler-type propylene glycol based antifreeze rather than an RV and Marine antifreeze or an automotive antifreeze-coolant.

If assistance is needed in locating a suitable anti-freeze, please contact the Aqua-Hot Heating Systems Product Application Department at +1 (800) 685-4298.

The 200 Series uses a 3-way directional valve to control the coolant priority. Therefore, the system must be filled as described below.

Fill Instructions

1. Locate the fill valve located on the top of the zone port outlet. Reference page 7 and page 8, part #6.
2. Make a 1/2” NPT connection from the propylene glycol source to the fill valve.
3. Make a 5/8” hose barb connection from the expansion bottle port to the return of the propylene glycol source
4. Locate the 3-way valve on the Aqua-Hot. Ensure that the sight glass is oriented as shown below
 - If the sight glass is not oriented in this way, pull the dial “Cap” out, and rotate it until the correct orientation is achieved.

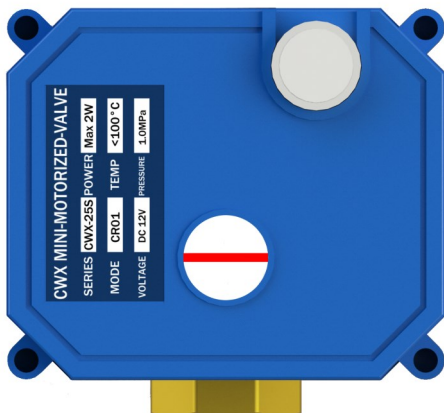

Figure 37

5. Attach the fluid expansion hose and the expansion bottle to the expansion tank port located atop the Aqua-Hot unit. Secure the hose as noted on page 12.

6. Activate the fluid transfer pump and begin filling the Aqua-Hot through the fill valve with a 50/50 mix of propylene glycol and distilled water.
7. Continue filling the Aqua-Hot until the fluid level is about mid-way between the “Hot” and “Cold” lines on the expansion bottle.
8. Once the bottle has been filled, deactivate the fluid pump, and disconnect the pump from the fill valve.
9. Activate the Aqua-Hot and set the thermostat to allow for interior heating. Allow the interior heating loop to run for at least 20 minutes to ensure that any air in the heating loop has been purged. If necessary, top off the propylene glycol solution at the fluid expansion bottle.



WARNING

Only propylene glycol based “boiler” antifreeze deemed “GRAS” by the FDA shall be used in the Aqua-Hot’s hydronic heating system. Failure to use approved anti-freeze could cause serious injury or death.



CAUTION

Ensure that the expansion tube is connected to both the expansion bottle and to the Aqua-Hot. Also ensure that the overflow hose connected to the top port on the expansion bottle, and allowed to flow out of the coach through the floor of the bay.

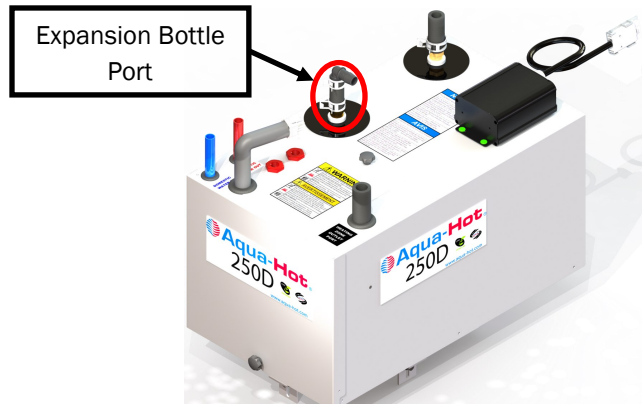

Figure 38

Aqua-Hot First Start-Up

The first start-up of the Aqua-Hot may not light-up perfectly. This is normal! On propane systems, fuel lines may not have been bled of air prior to first start-up. In this case, this non-combustible air must be purged from the system before the burner will light. The burner will attempt to light three times before entering a purge cycle. If that occurs, the Aqua-Hot must be power cycled to re-attempt first start-up. Please bear in mind that the first light may be noisy, however the second light should be quiet and stable.

The main access cover must be installed prior to operation. The access cover depresses a safety switch which will prevent unit operation if the cover is removed, or improperly installed.

Activation Instructions

1. Move the electric element switch to the “ON” position to supply the 120V AC electric Element with power (250P/250D models only.)
2. Allow approximately 1-2 hours for the electric element to heat the tank. Turn on a hot water faucet, and allow it to run until hot water flows. Once hot water is flowing, close the faucet. This will verify that the electric element is operating as it should.
3. Move the burner switch to the “ON” position to activate the diesel or propane burner. Allow the burner to run until it shuts itself off. Then, set the shower head in the coach to hot, and allow it to run until hot water flows. The burner should reactivate. This will verify the functionality of the burner.

It will take approximately 15 seconds before the burner will ignite and exhaust can be felt exiting the heater.

Both the 12V DC burner, and the electric element are thermostatically controlled. Either of these sources, or both will automatically work to maintain the temperature of the boiler tank’s antifreeze and water heating solution.

Once the heater has been brought to temperature by the electric element and/or 12V DC burner, activate interior heat by adjusting the room thermostat up until the heat exchangers activate. The interior heating will not function if there is a demand for hot water, or if the tank is below operating temperature. Therefore, shut off all hot water faucets, and allow the burner to heat until it shuts itself off before activating interior heat.

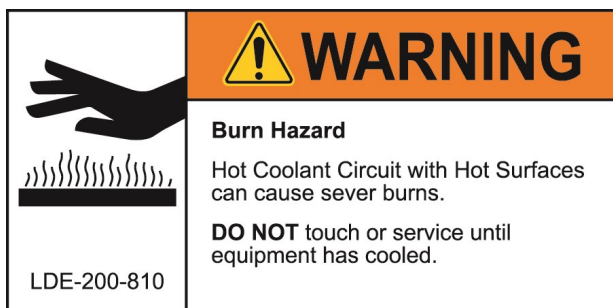

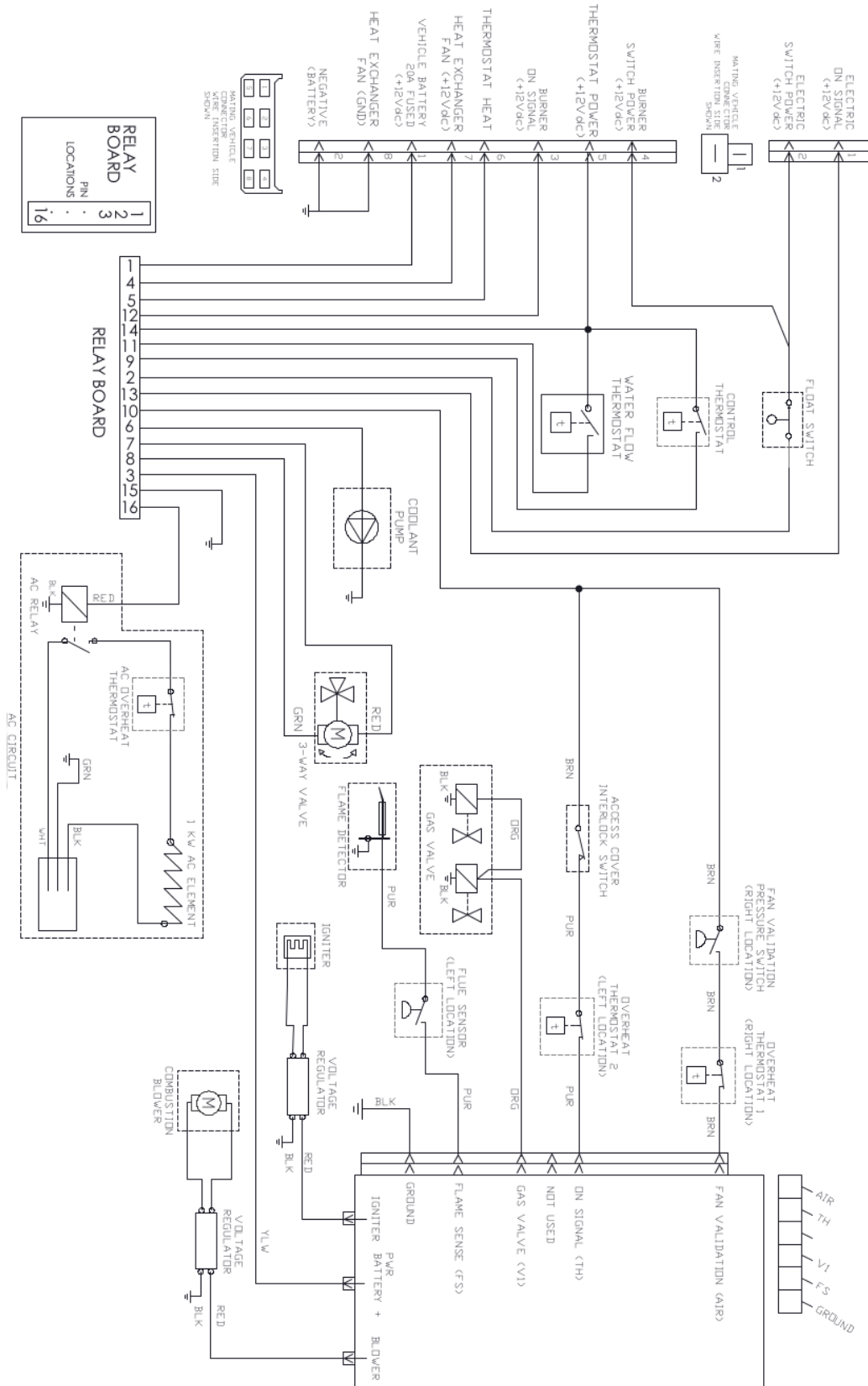

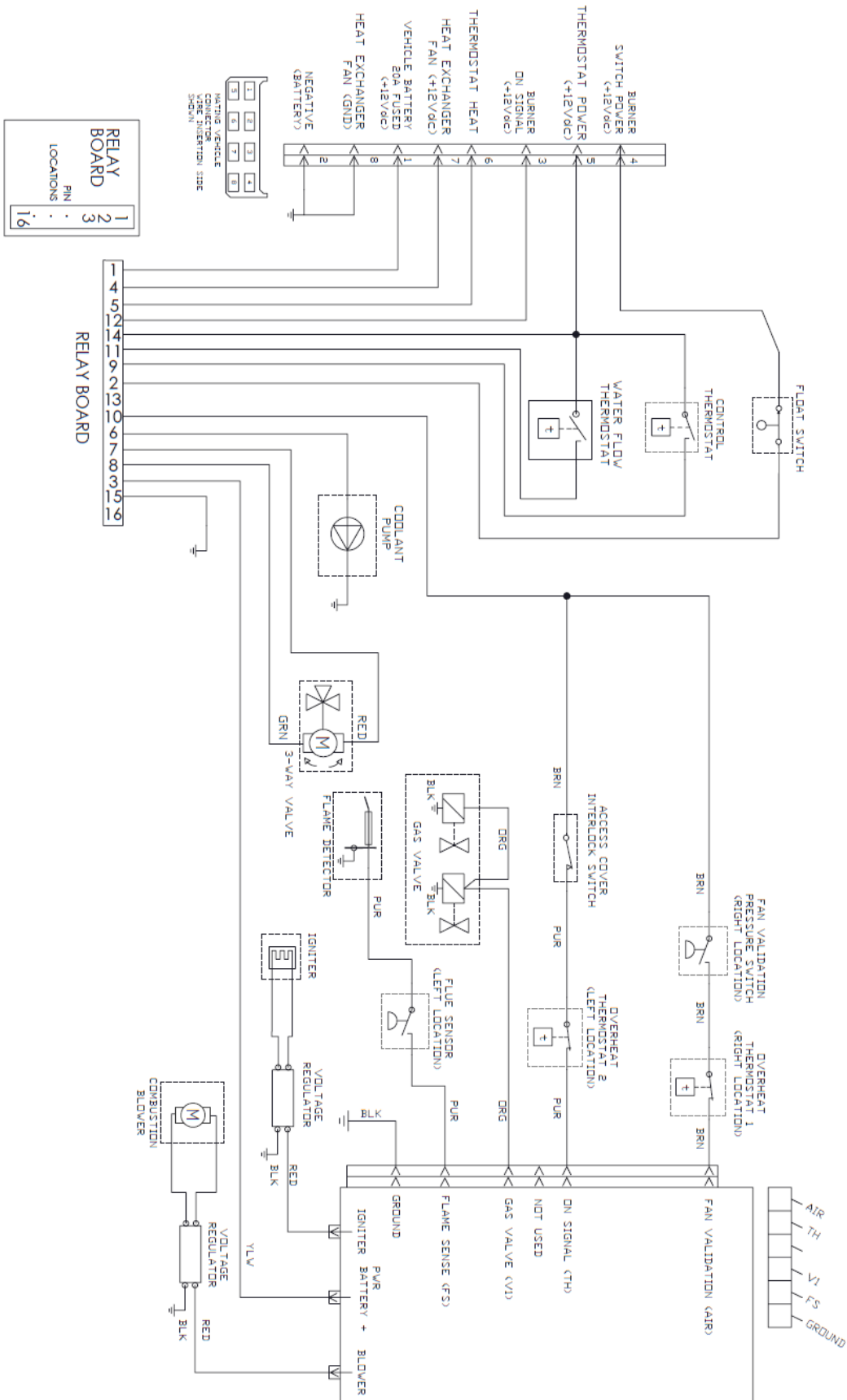

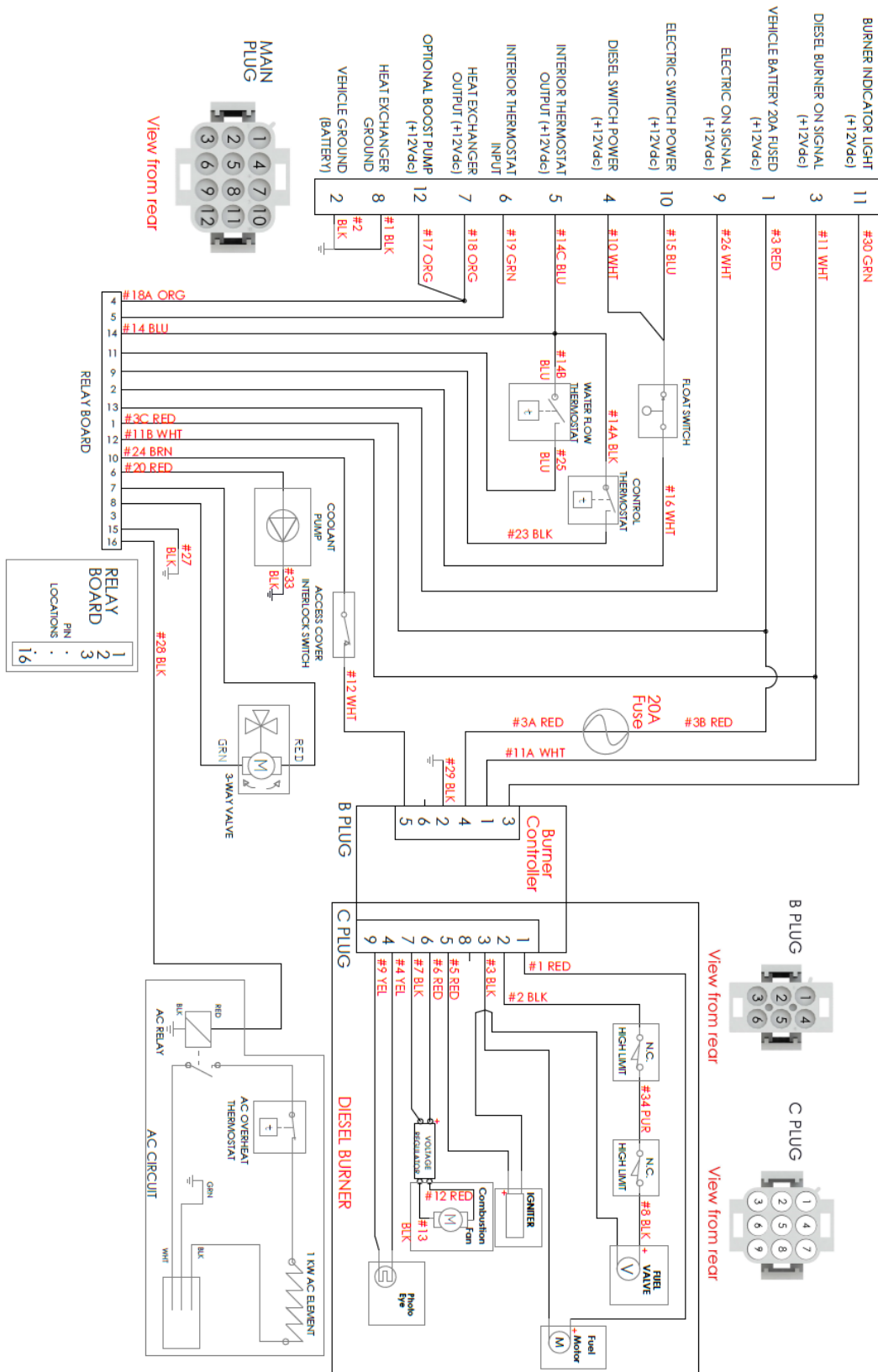

Appendix D: Measuring Propylene Glycol Using a Refractometer

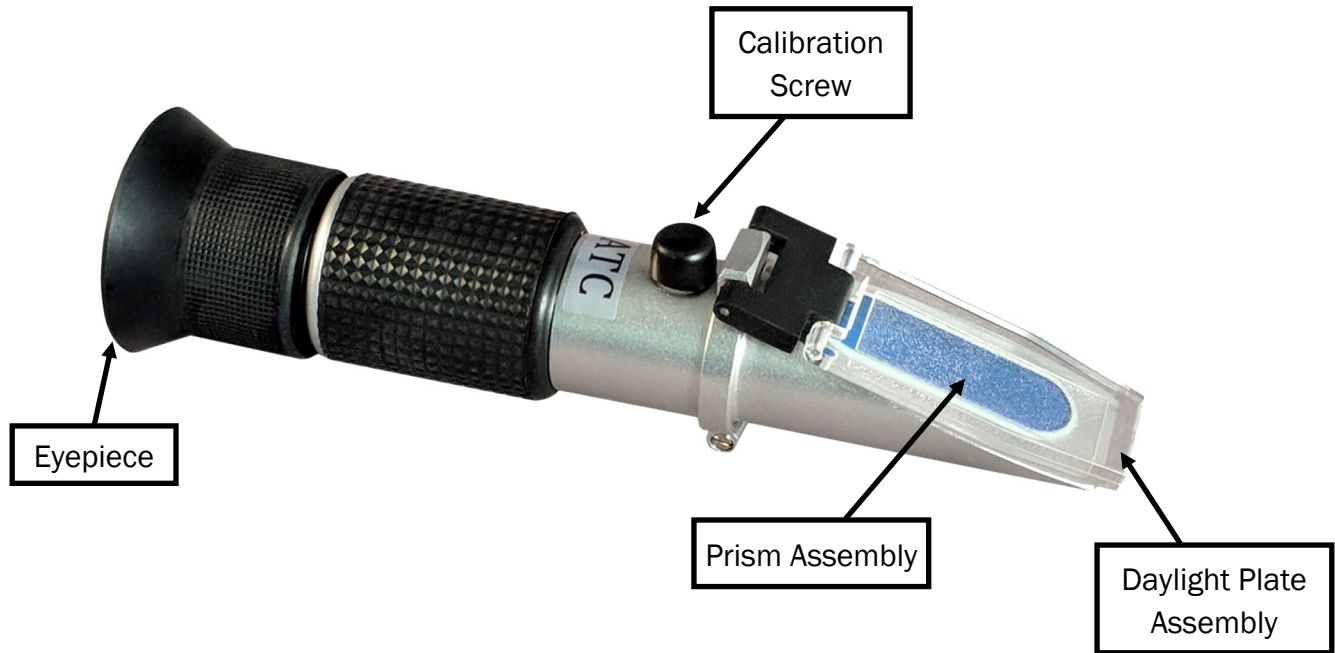

Properly Apply Antifreeze to the Prism Assembly

Use the guide below to properly apply the propylene glycol mixture to the prism assembly of the refractometer. Once that is complete, peer through the eyeglass of the refractometer to continue to the next step.

Adjust the Boundary Line

Once the glycol solution has been properly applied, adjust the calibration screw until the boundary line labelled "Propylene Glycol" is set to 32 °F. The graphic to the right has been designed as an aid, but note that it may differ from what is shown in the refractometer sight glass.

Refractometer Sight Glass

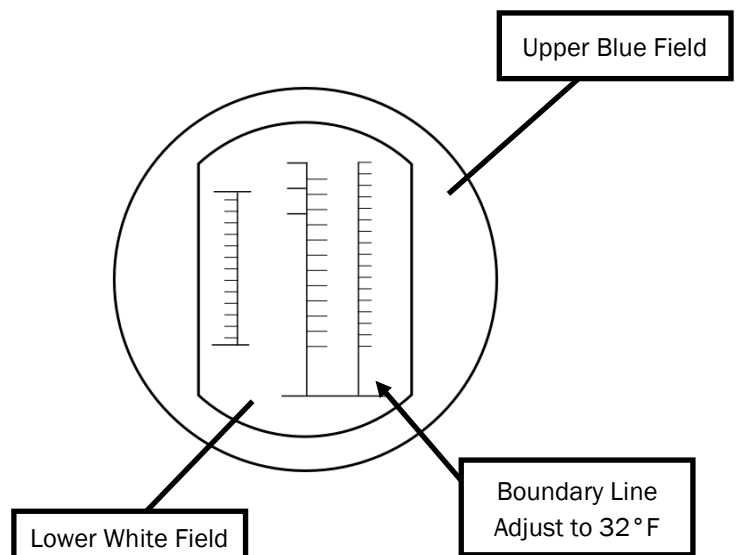

Application of Propylene Glycol

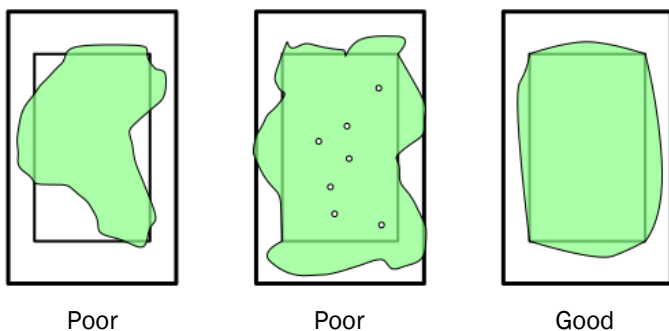

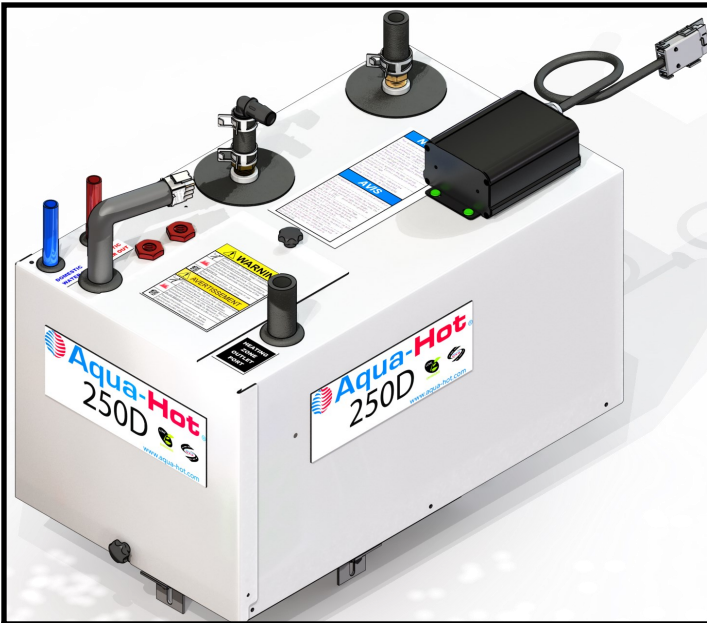

AHE-250-D01
250 Series Diesel w/Electric Element (1kW @120V AC)



AHE-200-P01
Aqua-Hot 200 Series Propane

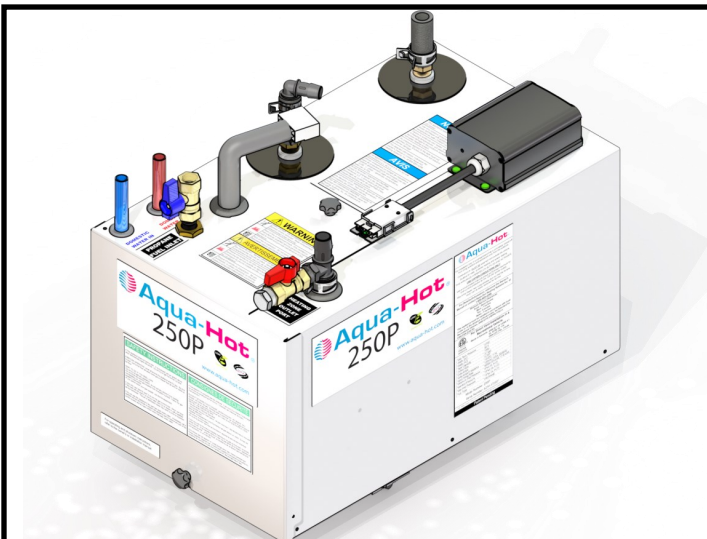

AHE-250-P01
250 Series Propane w/Electric Element (1kW @120V AC)

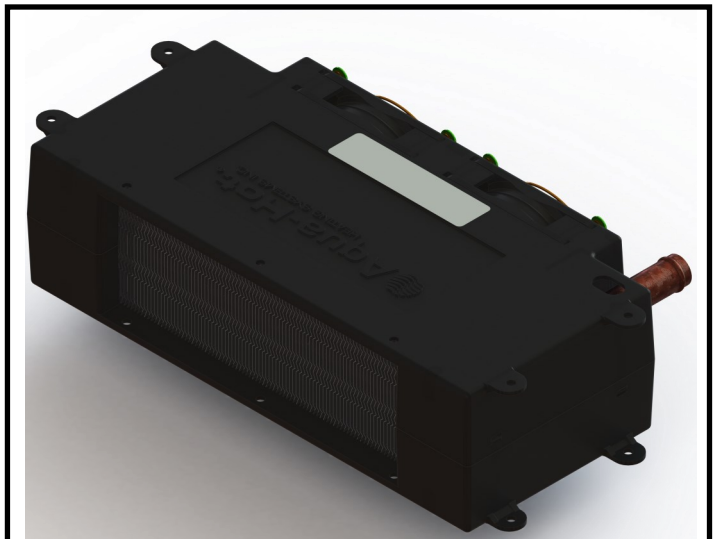

EXE-103-OEX
Heat Exchanger, Cozy III



ELE-000-508
Panel, Switch, 2 Position ASM



MSE-200-EXH
Exhaust Kit



EXX-013-100
Nozzle, Round 4" w/o Connector, Black



PLX-CTB-270
Clamp, Hose, Constant Tension, 0.75"



SME-102-000
Cozy Plenum Assembly



PLX-T44-006
Fitting, Insert Modified Brass



PLX-284-74V
Hose, Molded, Elbow 90°



ELX-700-007
Room Thermostat, Positive Off

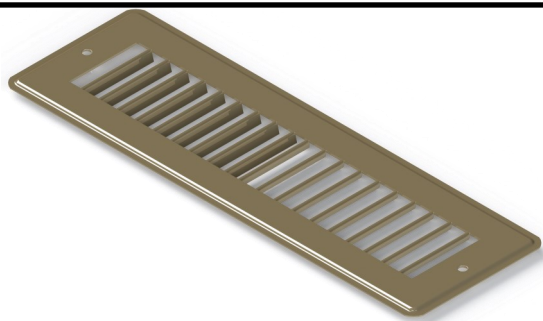

EXX-950-411
Grille, 10" x 2" Cozy



EXX-006-500
Grille, Long, 3.5" x 21.5", Black

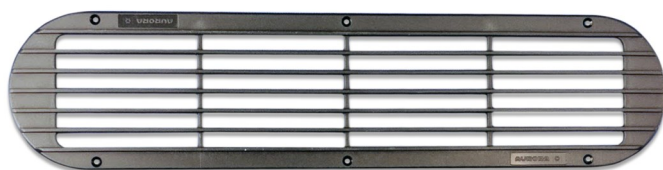

EXX-006-501
Grille, Medium, 3.5" x 15", Black



EXX-006-502
Grille, Small, 3.5" x 8.5", Black



PLX-000-443
Tube, 5/8" Safety Stripe, 12ft.



PLX-A51-106
Bend Support, 5/8"



PLX-A65-200
Fitting, Brass Barb, 3/4" x 1/2" (M) NPT



PLX-A65-300
Fitting, Brass, Barb 90°, 3/4" x 1/2" (M) NPT



PLX-000-820
Fitting, Elbow, 90°, 3/4", Barb, Black Nylon



PLX-200-103
Fitting 1/2" (M) NPT x 3/4" Barb Black Nylon



PLX-000-835
Fitting, Reducer 3/4" to 5/8" Black Nylon



PLX-432-000
Fitting, Straight, 1/2" PEX x 1/2" (M)NPT PSF



PLX-803-000
Fitting, Straight, 1/2" PEX x 1/2" (F) NPT



PLX-100-836
Pump Mounting Bracket



PLX-803-ELB
Elbow Fitting, 90°, 1/2" PEX x 1/2" PSF

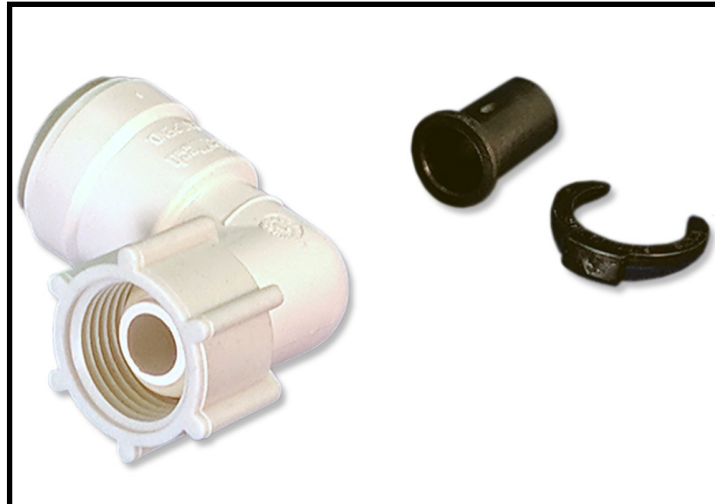

PLX-803-FSE
Elbow Fitting, 90°, 1/2" PEX Fitting



EXE-505-65A
Heat Exchanger, Whisper Silent, 12V DC



PLX-664-730
Fitting, Pipe Nipple, Exhaust, 1-1/2" x 4"



PLX-664-750
Fitting, Exhaust Nipple, 1-1/2" x 3" NPT

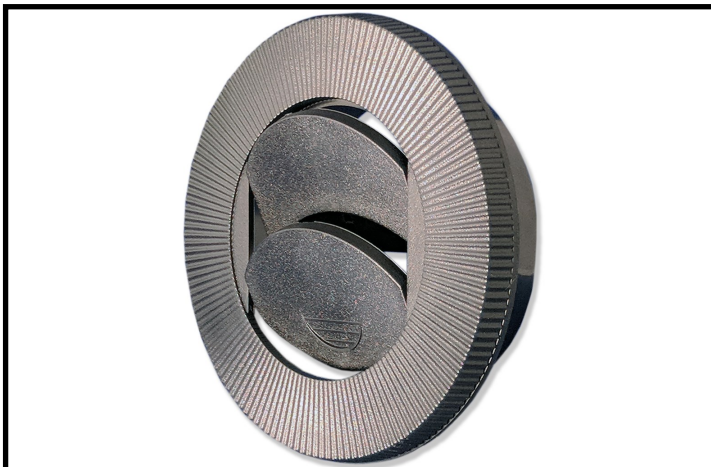

EXX-013-105
Nozzle, 4" Round, w/ 2-1/2" Connector, Black



SME-400-015
Tip, Exhaust End



MSX-300-300
Anti-freeze, 1-gallon, green boiler



MSX-300-270
Anti-freeze, 1-gallon, pink boiler



MSX-300-275
Propylene Glycol Concentrate, Pink



PLX-100-900
Boost Pump



ELE-400-900
Boost Pump Harness



PLE-063-200
Overflow Bottle Kit, (Tank, hose, clamp, tie, labels)

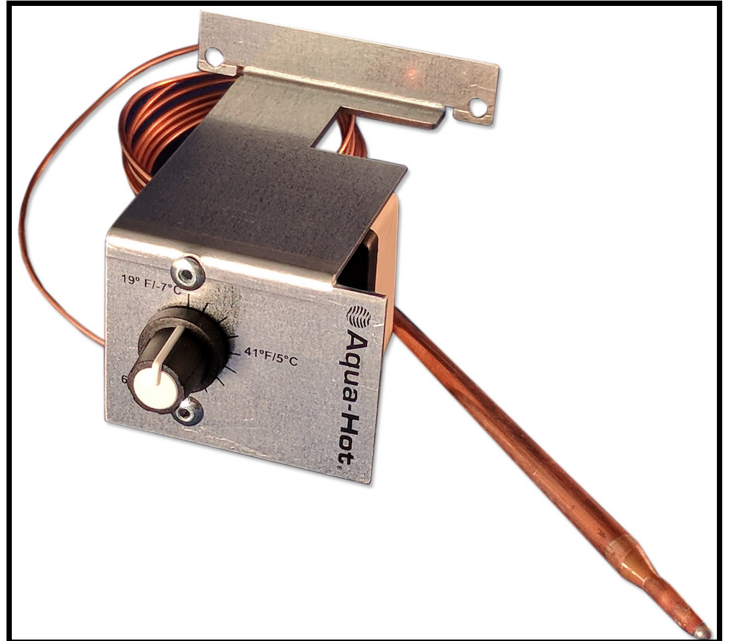

ELX-500-510
Low Temperature Thermostat Assembly



2-YEAR LIMITED WARRANTY AQUA-HOT® HYDRONIC HEATING SYSTEM

Aqua-Hot Heating Systems Inc. warrants the Aqua-Hot Heater to be free from defects in material and workmanship under normal use and service for a period of two years on both parts and labor commencing upon the original date of registration of the vehicle. Replacement parts are warranted for the remainder of the Heater's standard warranty coverage or for six months, whichever is greater. The intent of this warranty is to protect the heater's end-user from such defects, which would occur in the manufacturing of the product. Thus, problems due to improper specifications, improper installations, improper use, the use of accessory parts or parts not authorized by Aqua-Hot Heating Systems Inc., repair by unauthorized persons, and damage or abuse of the heater are specially excluded from warranty coverage.

For additional information, or to obtain a warranty repair authorization, please contact the *Aqua-Hot Heating Systems Warranty Administrator* at 1-800-685-4298 (7:00 AM to 4:00 PM Mountain Standard Time) or visit www.aqua-hot.com.

My Comfort Zones are On-Board

Vehicle:

Purchased From:

Dealer Information:

Name:

Location:

Phone Number:

Heating System:

Serial Number:

INSTALLATION MANUAL

200 SERIES



200P, 250P and 250D



Aqua-Hot Heating Systems, Inc.
7501 Miller Drive, Frederick, CO 80504

Visit us on line at www.aquahot.com
Call us at (800) 685-4298 or (303) 651-5500

©2018 Aqua-Hot Heating Systems Inc. Printed In U.S.A.