

order no.:	29.026	date:	15.09.1999
mach.no.:	990820	drawer:	A. Könnemann
KS-file:	50990820.PRO	modify no.:	
d. carrier:	. filing	01	modify:

GVM
 Vakuum Tisch
 Westwind D1296
 Meßtaster

Indramat MTC 200
 drill-bit gauging
 Handbediengerät EBG 2
 synchron Linearantriebe, DIAXQ4

customer:
 Xynatech
 New Mexico

power input
 Leistungsversorgung
 circuit diagram



E. Wessel GmbH & Co.KG
 electr. produk. equip.
 Tel.: D - 05231/9663-0
 32758 Delmold Farbenweg 6

= Rack + GVM	sheet1
	72 sh.

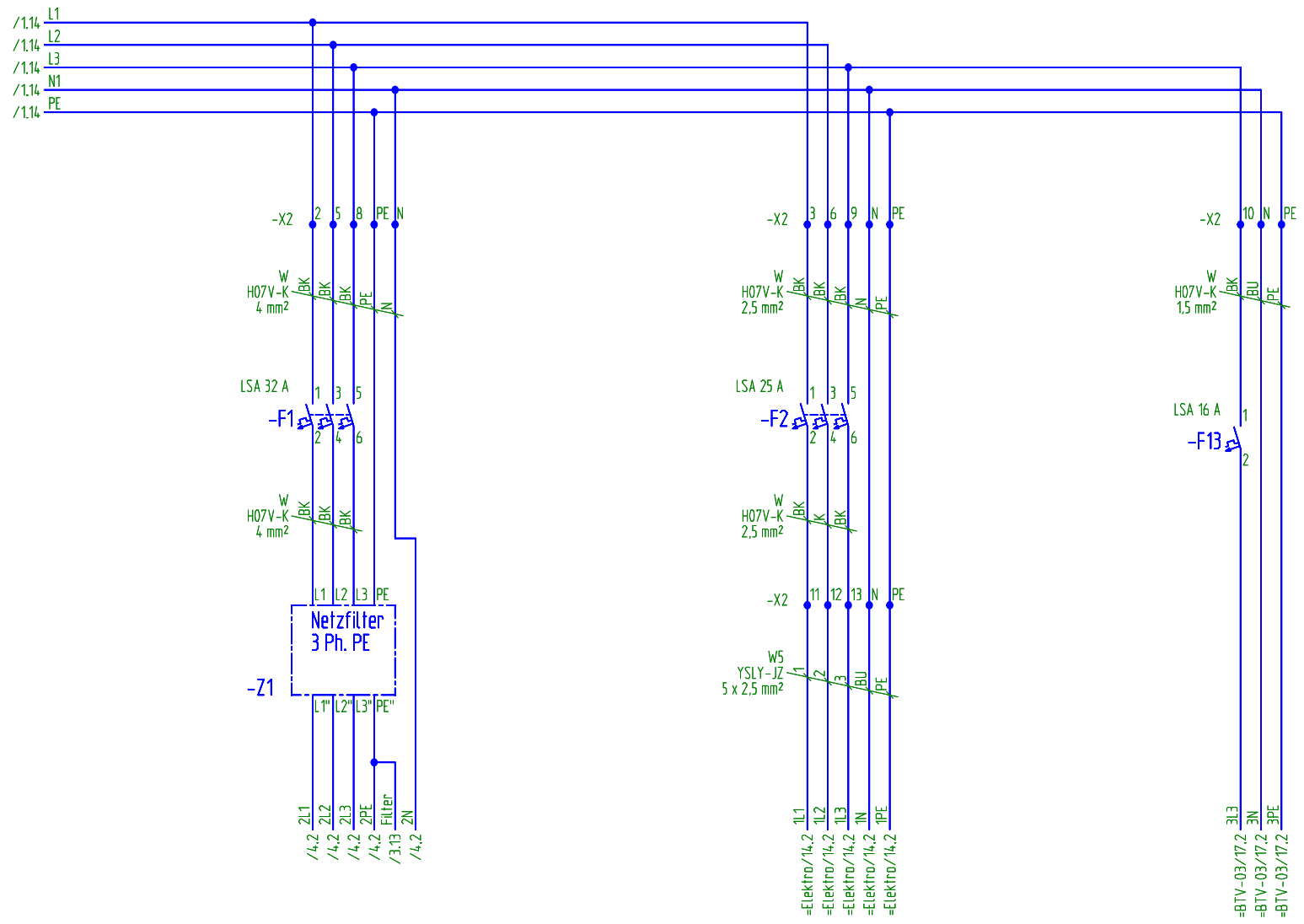

order no.:	29.026	date:	15.09.1999
mach.no.:	990820	drawer:	A. Könnemann
KS-file:	50990820.PRO	modify no.:	
d. carrier:		filing:	01
		modify:	

GVM
 Vakuu Tisch
 Westwind D1296
 Meßtaster

Indramat MTC 200
 drill-bit gauging
 Handbediengerät EBG 2
 synchron Linearantriebe, DIAX04

customer:
 Xynatech
 New Mexico

power input
 power supply 1
 circuit diagram



E. Wessel GmbH & Co.KG
 electr. produk. equip.
 Tel.: D - 05231/9663-0
 32758 Delmold Farbenweg 6

= Rack
 + GVM
 sheet 2
 72 st.

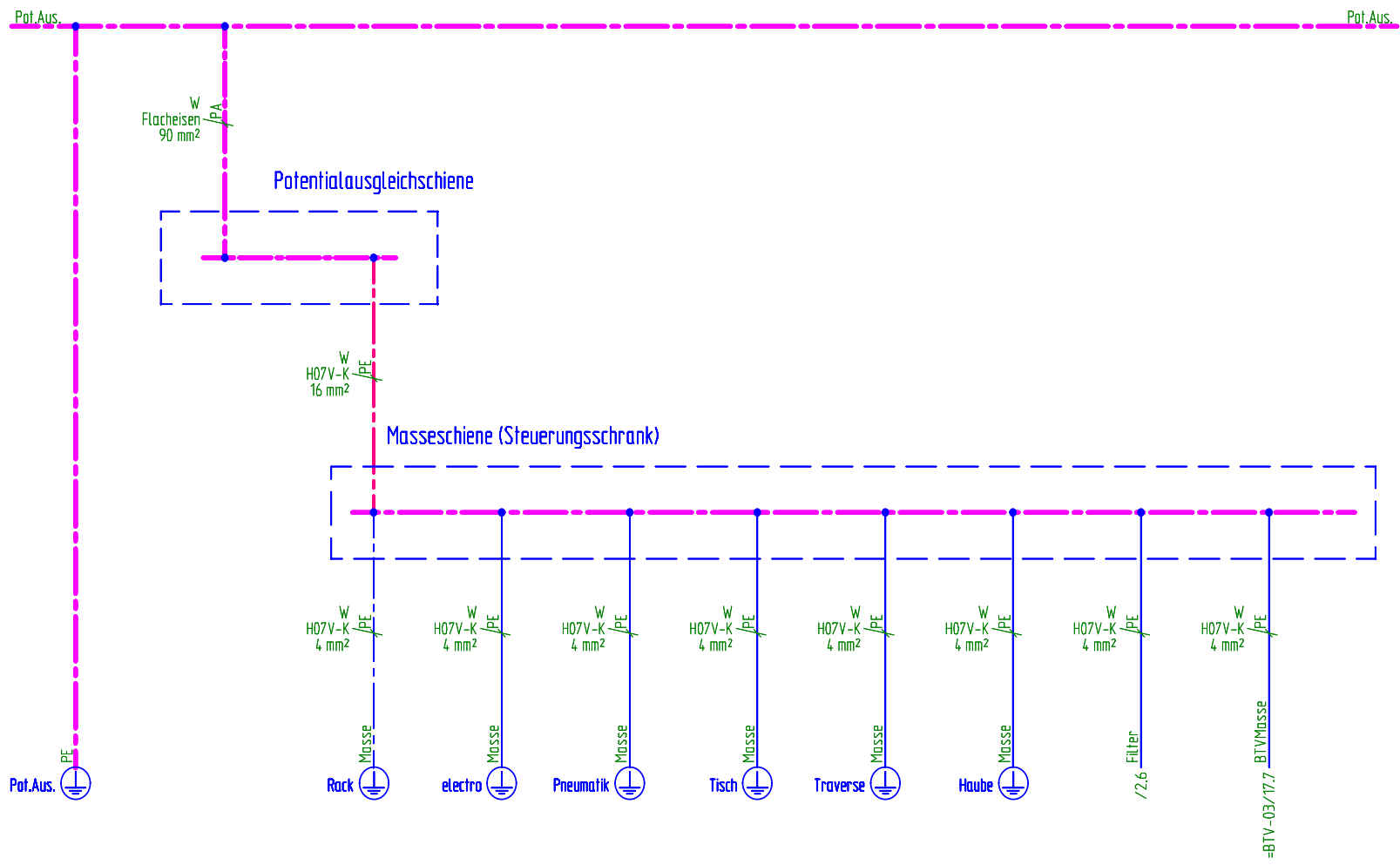

order no.:	29.026	date:	15.09.1999
mach.no.:	990820	drawer:	A. Könnemann
KS-file:	50990820.PRO	modify no.:	
d. carrier:		filing:	01
		modify:	

GVM
 Vakuu Tisch
 Westwind D1296
 Meßtaster

Indramat MTC 200
 drill-bit gauging
 Handbediengerät EBG 2
 synchron Linearantriebe, DIAX04

customer:
 Xynatech
 New Mexico

Potentialausgleich
 circuit diagram



E. Wessel GmbH & Co.KG
 electr. produk. equip.
 Tel.: D - 05231/9663-0
 32758 Detmold Farbenweg 6

= Rack + GVM	sheet3
	72 sh.

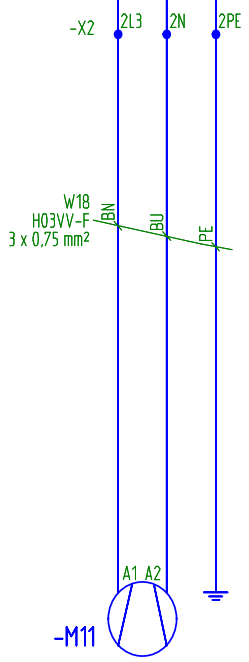
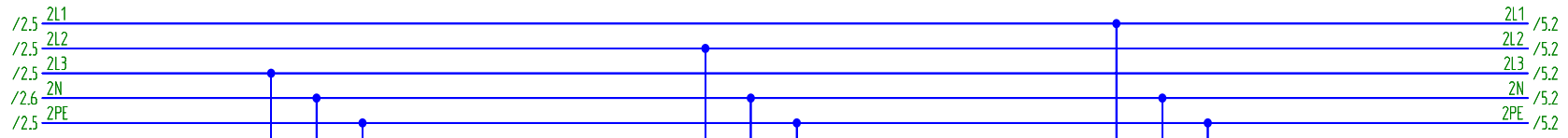

Lüfter SFU

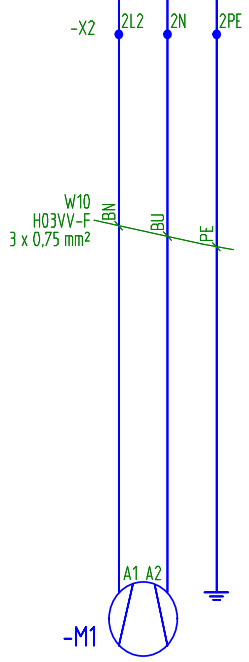

Klimagerät

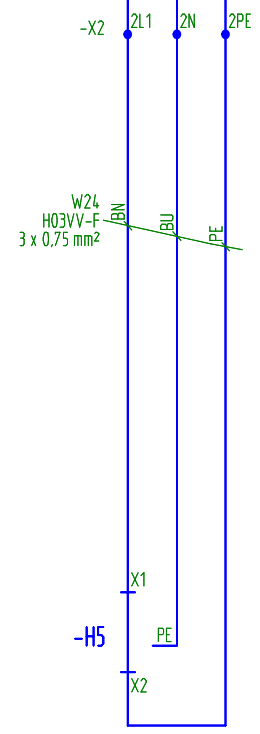

lighting

order no.:	29.026	date:	15.09.1999
mach.no.:	990820	drawer:	A. Käsemann
KS-file:	50990820.PRO	modify no.:	
d. carrier:		filing:	01

GVM	Indramat MTC 200	customer:	Xynatech
Vakuum Tisch	drill-bit gauging		
Westwind D1296	Hanbediengerät EBG 2		
Meßtaster	synchron Linearantriebe, DIAX04	New Mexico	

Leistungsversorgung
circuit diagram



E. Wessel GmbH & Co.KG
electr. produk. equip.
Tel.: D - 05231/9663-0
32758 Detmold, Farbenweg 6

= Rack	sheet 4
+ GVM	
	72 st.

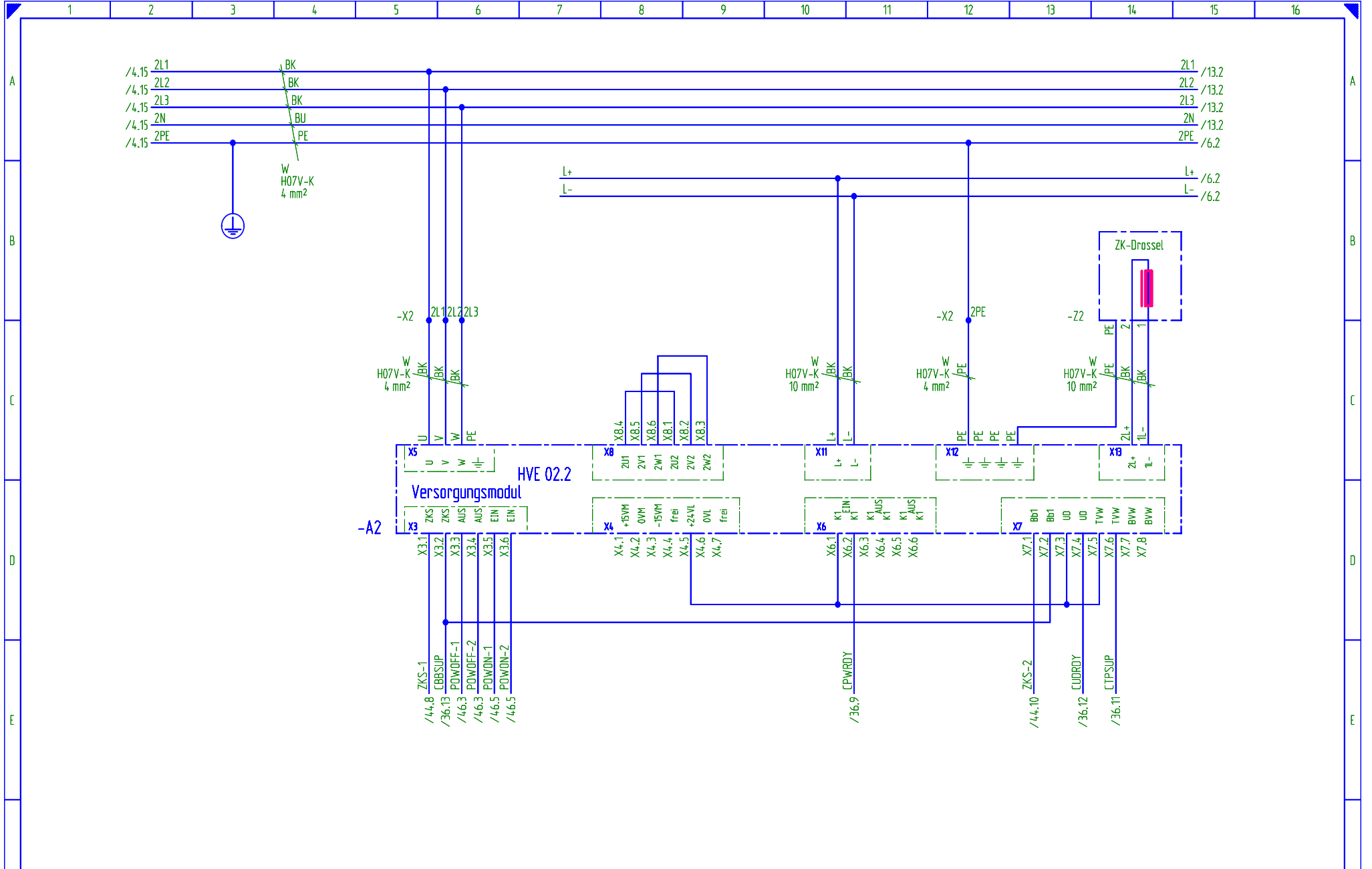

order no.:	29.026	date:	15.09.1999
mach.no.:	990820	drawer:	A. Könnemann
KS-file:	50990820.PRO	modify no.:	
d. carrier:		modify:	

GVM
 Vakuu Tisch
 Westwind D1296
 Meßtaster

Indramat MTC 200
 drill-bit gauging
 Handbediengerät EBG 2
 synchron Linearantriebe, DIAX04

customer:
 Xynatech
 New Mexico

Netzanschlußmodul
Digitale Drehstromsteller
 circuit diagram



E. Wessel GmbH & Co.KG
 electr. produk. equip.
 Tel.: D - 05231/9663-0
 32758 Detmold Farbenweg 6

= Rack	sheet5
+ GVM	
	72 st.

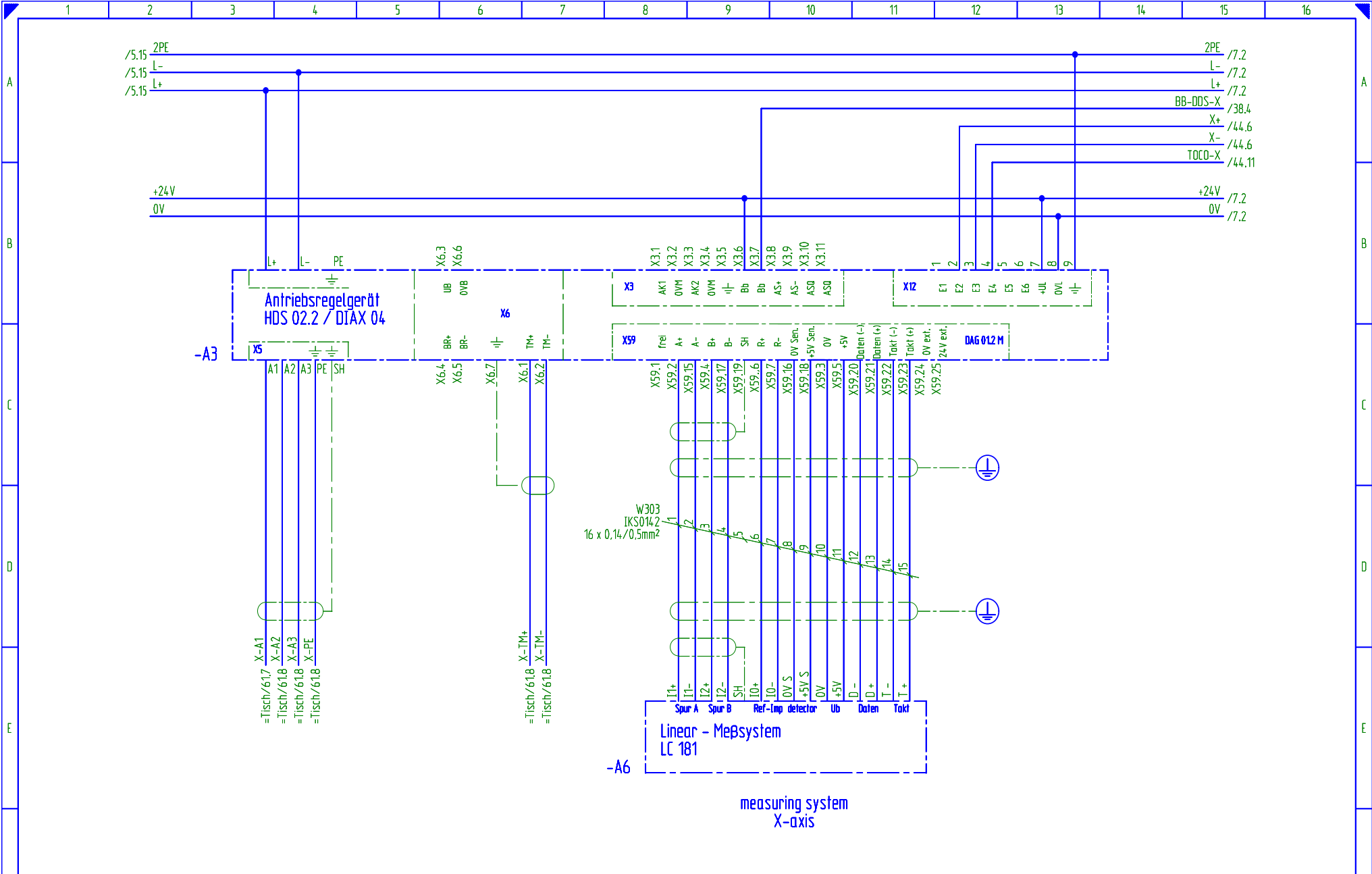

order no.:	29.026	date:	15.09.1999
mach.no.:	990820	drawer:	A. Könnemann
KS-file:	50990820.PRO	modify no.:	
d. carrier:	. filing	01	modify:

GVM	Indramat MTC 200	customer:	
Vakuu Tisch	drill-bit gauging	Xynatech	
Westwind D1296	Handbediengerät EBG 2		
Meßtaster	synchron Linearantriebe, DTAX04	New Mexico	

**Antriebsregler
X-axis**

circuit diagram



E. Wessel GmbH & Co.KG
electr. produk. equip.
Tel.: D - 05231/9663-0
32758 Detmold Farbenweg 6

= Rack	sheet 6
+ GVM	
	72 st.

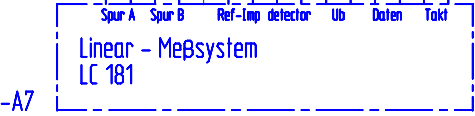
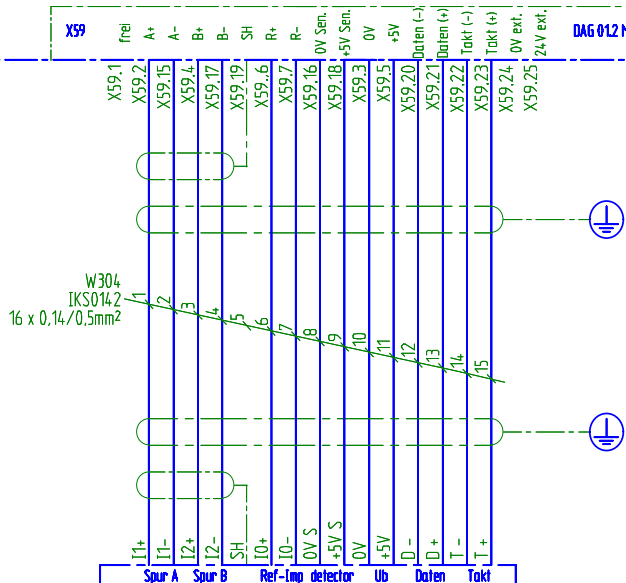
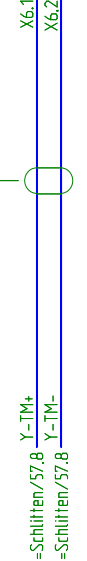
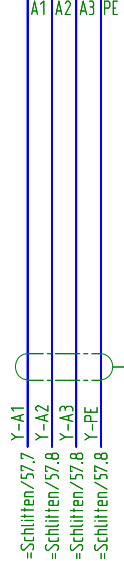
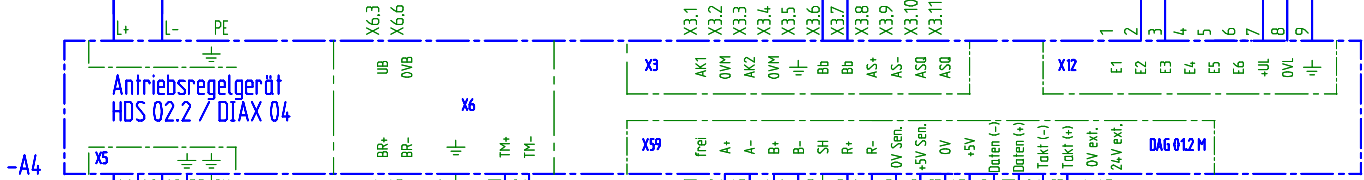
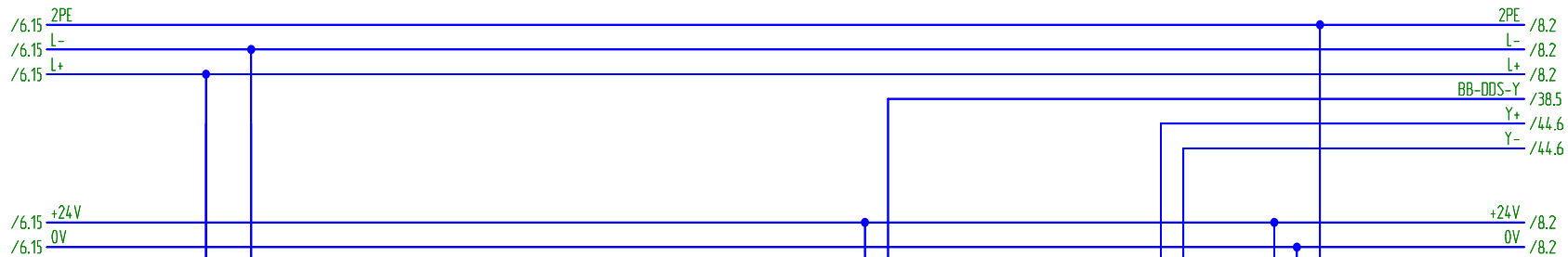

measuring system
Y-axis

order no.:	29.026	date:	15.09.1999
mach.no.:	990820	drawer:	A. Könnemann
KS-file:	50990820.PRO	modify no.:	
d. carrier:		filing:	01

GVM
Vakuu Tisch
Westwind D1296
Meßtaster

Indramat MTC 200
drill-bit gauging
Handbediengerät EBG 2
synchron Linearantriebe, DTAX04

customer:
Xynatech
New Mexico

**Antriebsregler
Y-axis**
circuit diagram



E. Wessel GmbH & Co.KG
electr. produk. equip.
Tel.: D - 05231/9663-0
32758 Detmold Farbenweg 6

= Rack
+ GVM
sheet 7
72 st.

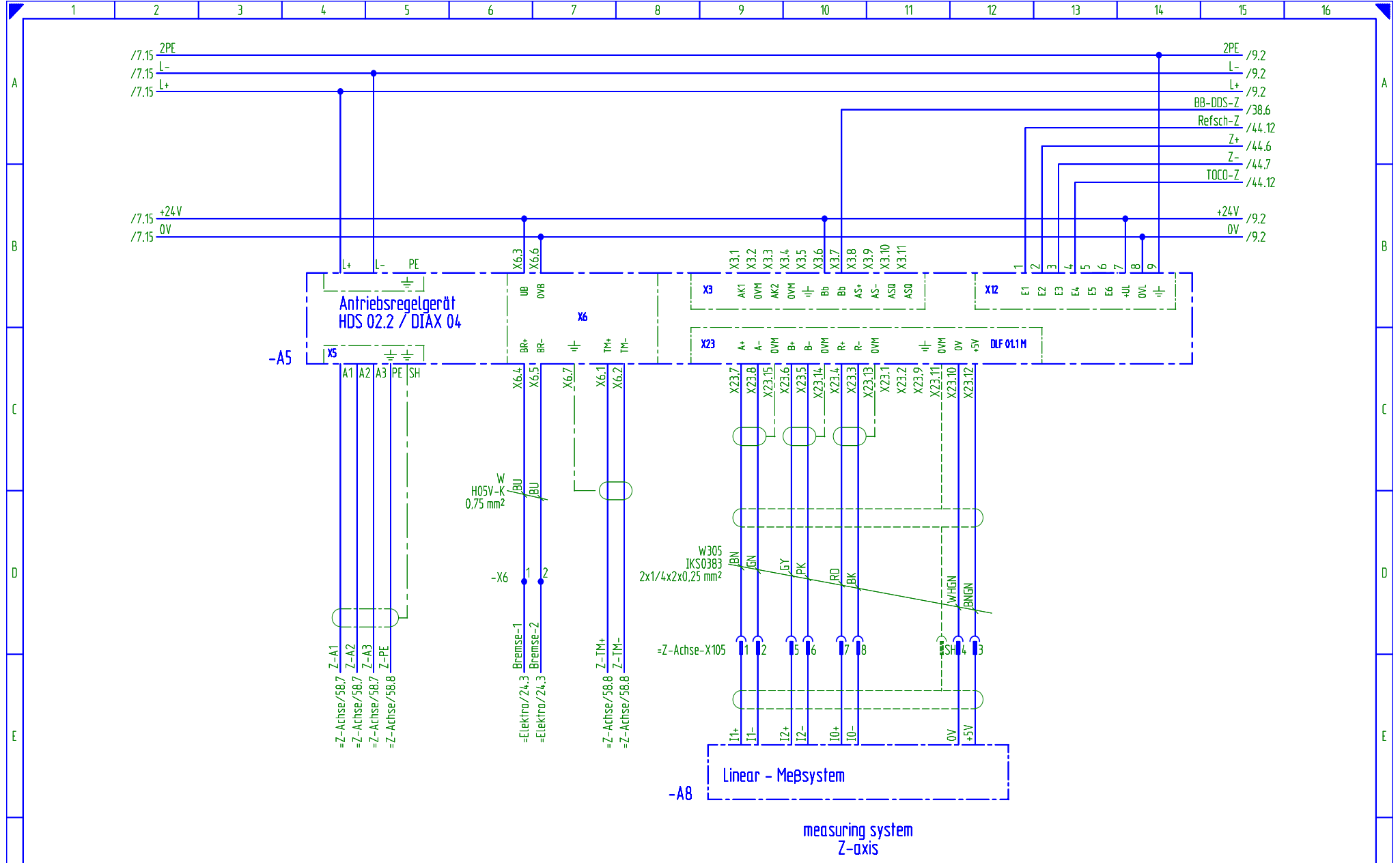

order no.:	29.026	date:	15.09.1999
mach.no.:	990820	drawer:	A. Käsemann
KS-file:	50990820.PRO	modify no.:	
d. carrier:		filing:	01

GVM
 Vakuum Tisch
 Westwind D1296
 Meßtaster

Indramat MTC 200
 drill-bit gauging
 Handbediengerät EBG 2
 synchron Linearantriebe, DIAX04

customer:
 Xynatech
 New Mexico

**Antriebsregler
 Z-axis**
 circuit diagram

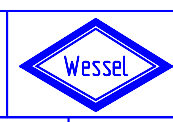

E. Wessel GmbH & Co.KG
 electr. produk. equip.
 Tel.: D - 05231/9663-0
 32758 Delmold Farbenweg 6

= Rack + GVM	sheet 8
	72 st.

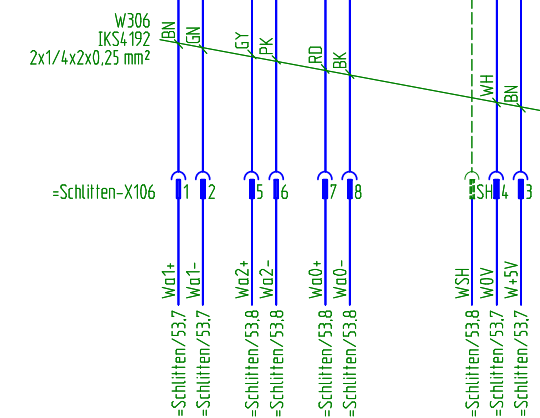
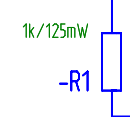
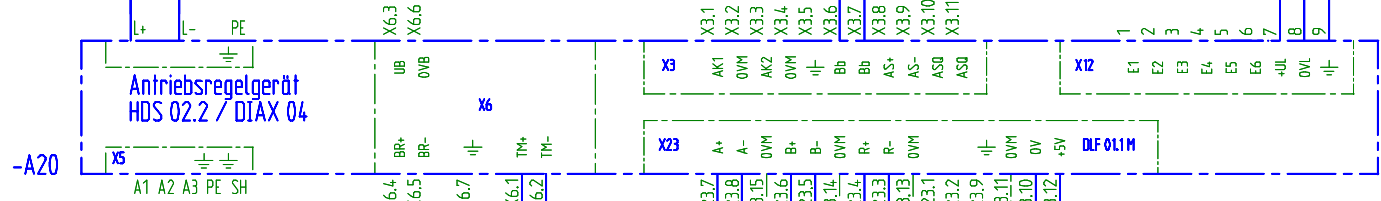
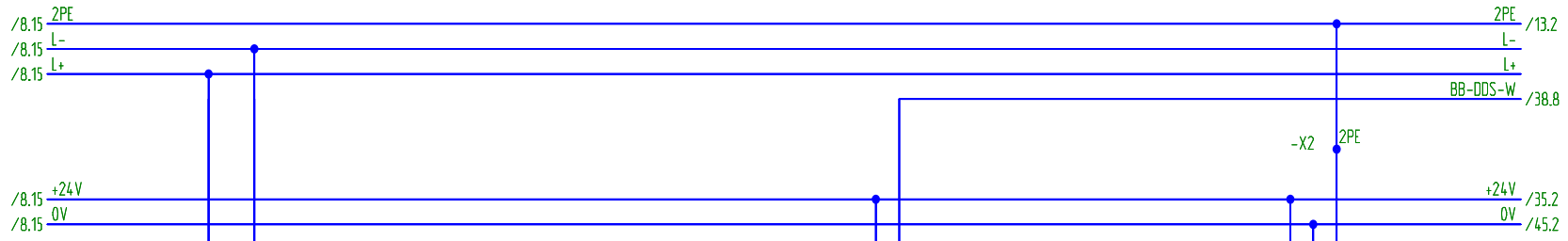

order no.:	29.026	date:	15.09.1999	GVM	Indramat MTC 200	customer:	Antriebsregler W-Achse			E. Wessel GmbH & Co.KG electr. produk. equip. Tel.: D - 05231/9663-0 32758 Detmold Farbenweg 6	= Rack
mach.no.:	990820	drawer:	A. Könnemann	Vakuum Tisch	drill-bit gauging	Xynatech	circuit diagram				+ GVM
KS-file:	50990820.PRO	modify no.:		Westwind D1296	Handbediengerät EBG 2						sheet 9
d. carrier:		filing	01	Meßtaster	synchron Linearantriebe, DIAX04	New Mexico					72 sh.

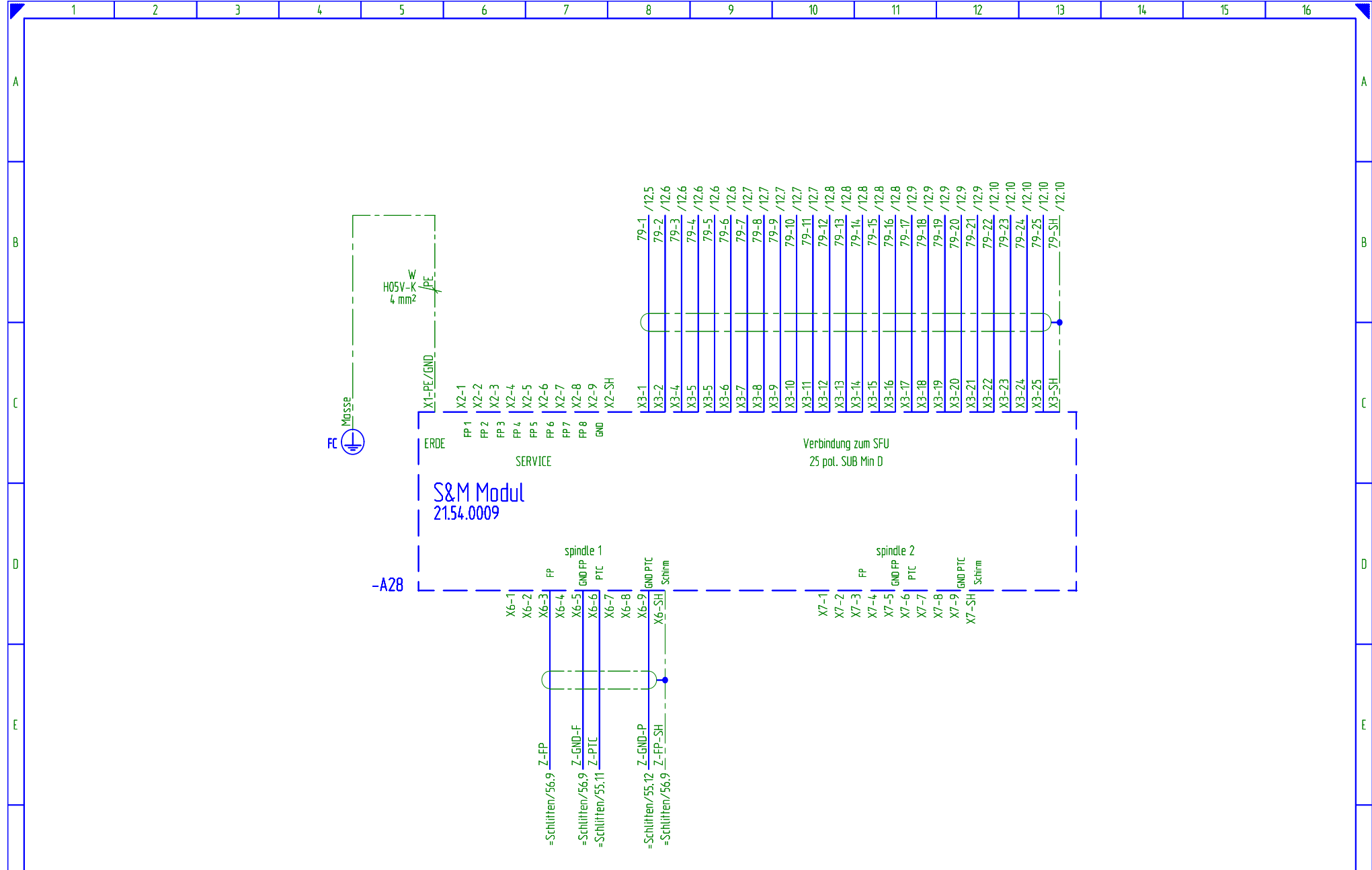

order no.:	29.026	date:	15.09.1999
mach.no.:	990820	drawer:	A. Könnemann
KS-file:	50990820.PRO	modify no.:	
d. carrier:	. filing 01	modify:	

GVM
 Vakuu Tisch
 Westwind D1296
 Meßtaster

Indramat MTC 200
 drill-bit gauging
 Handbediengerät EBG 2
 synchron Linearantriebe, D1AX04

customer:
 Xynatech
 New Mexico

Spindelanschlußmodule
 Precise SC 62 M / 3 ph.

circuit diagram



E. Wessel GmbH & Co.KG
 electr. produk. equip.
 Tel.: D - 05231/9663-0
 32758 Detmold Farbenweg 6

= Rack + GVM	sheet 10
	72 sh.

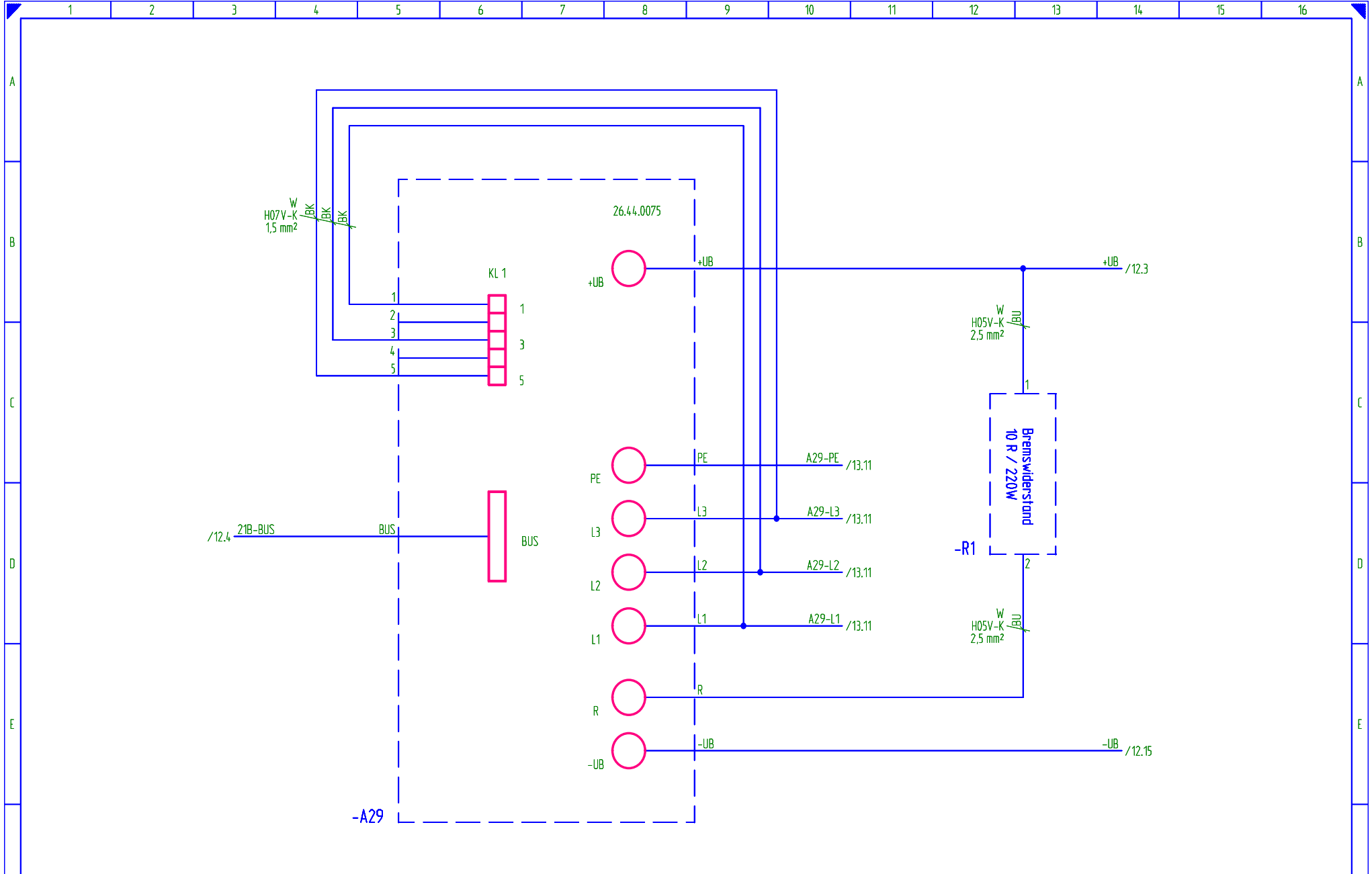

order no.:	29.026	date:	15.09.1999
mach.no.:	990820	drawer:	A. Könnemann
KS-file:	50990820.PRO	modify no.:	
d. carrier:	. filing	01	modify:

GVM
 Vakuu Tisch
 Westwind D1296
 Meßtaster

Indramat MTC 200
 drill-bit gauging
 Handbediengerät EBG 2
 synchron Linearantriebe, DIAXQ4

customer:
 Xynatech
 New Mexico

Stat. Frequenz Umformer
Leistungsversorgung
 circuit diagram



E. Wessel GmbH & Co.KG
 electr. produk. equip.
 Tel.: D - 05231/9663-0
 32758 Detmold Farbenweg 6

= Rack	sheet 11
+ GVM	
	72 sh.

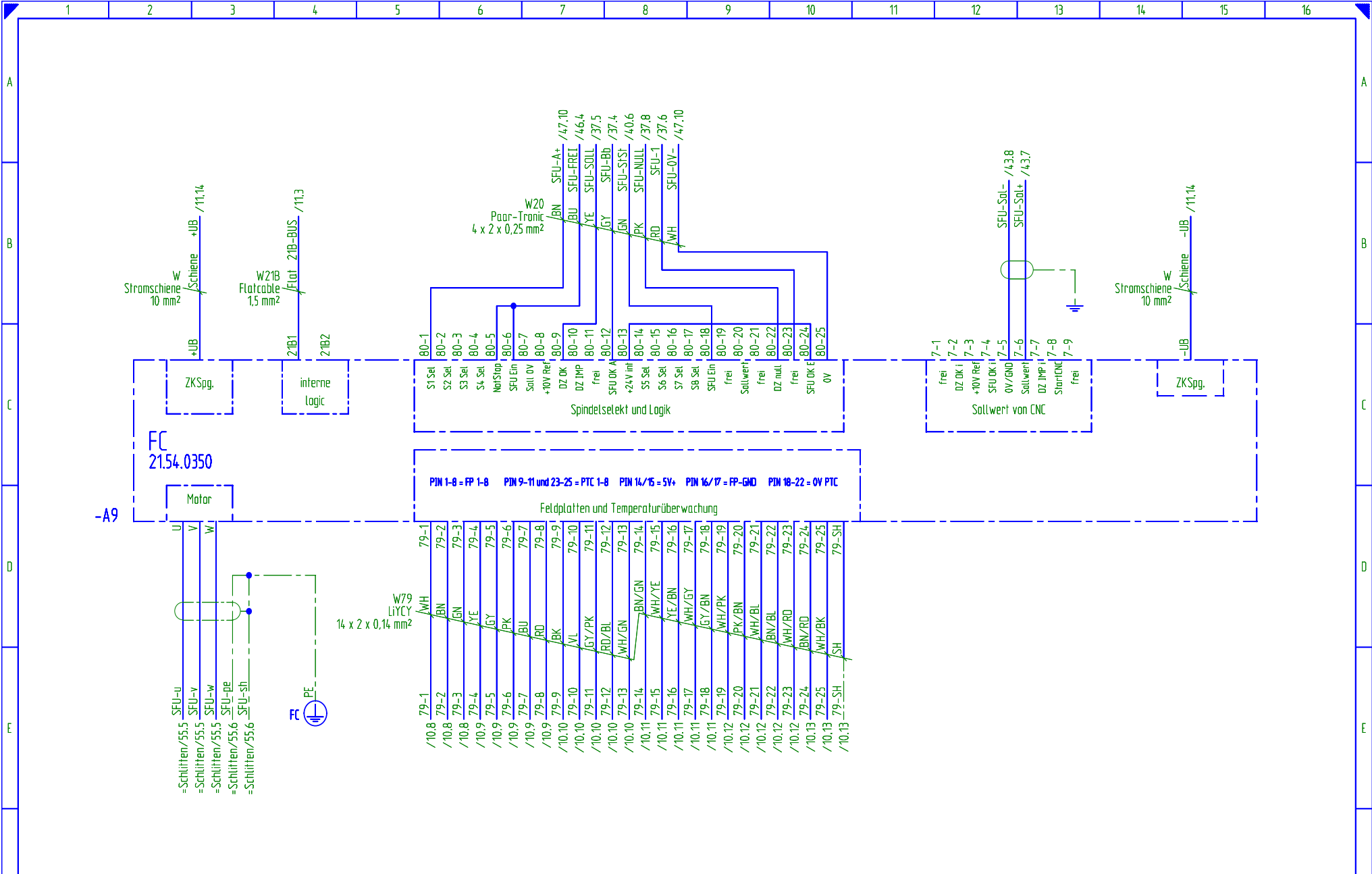

order no.:	29.026	date:	15.09.1999
mach.no.:	990820	drawer:	A. Käsemann
KS-file:	50990820.PRO	modify no.:	
d. carrier:		modify:	

GVM	Indramat MTC 200	customer:	Xynatech
Vakuum Tisch	drill-bit gauging		
Westwind D1296	Handbediengerät EBG 2		
Meßtaster	synchron Linearantriebe, OIAX04	New Mexico	

Stat. Frequenz Umformer
Westwind D 1296
 circuit diagram



E. Wessel GmbH & Co.KG
 electr. produk. equip.
 Tel.: D - 05231/9663-0
 32758 Detmold Farbenweg 6

= Rack	sheet 12
+ GVM	
	72 st.

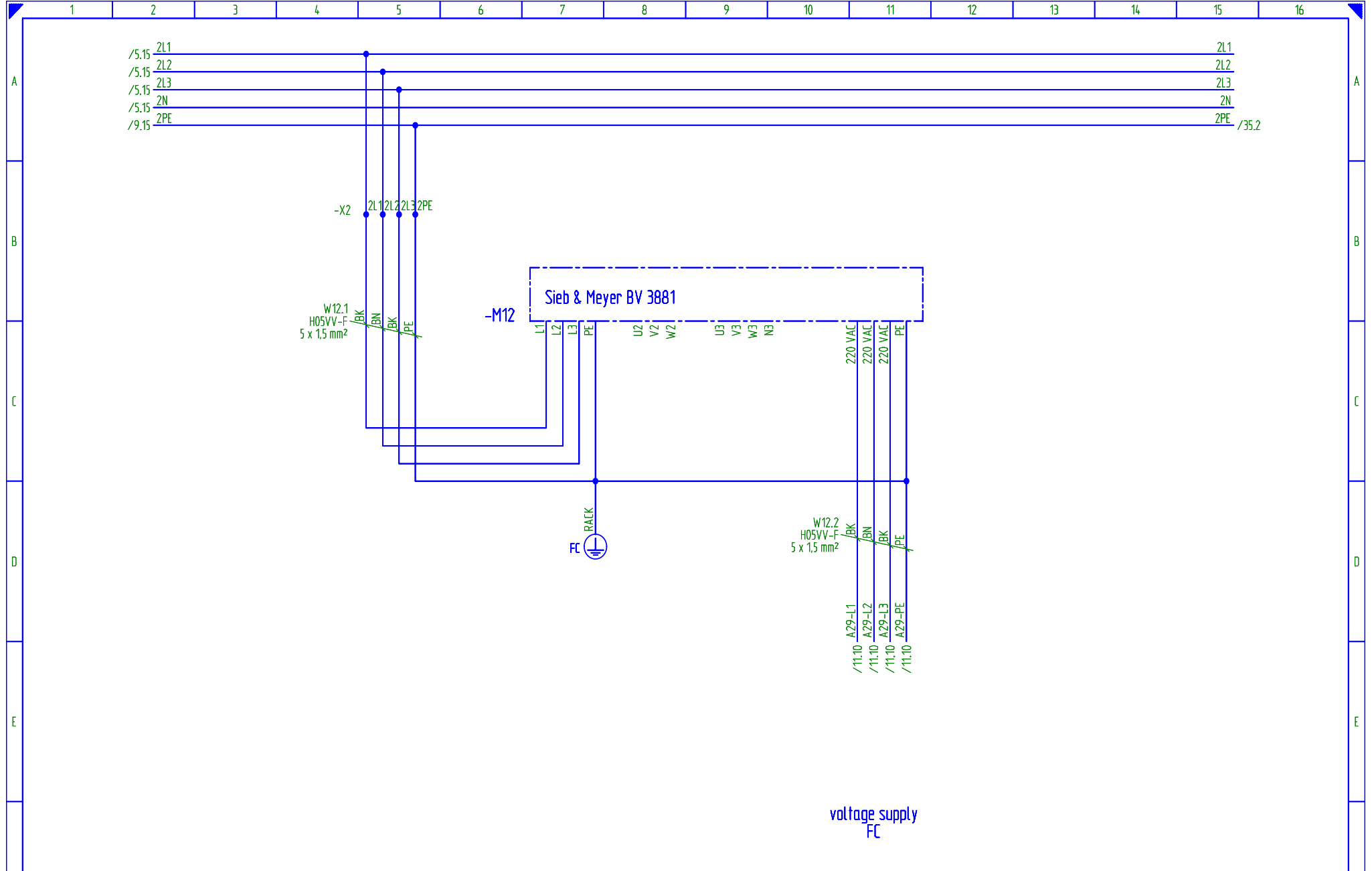

order no.:	29.026	date:	15.09.1999
mach.no.:	990820	drawer:	A. Könnemann
KS-file:	50990820.PRO	modify no.:	
d. carrier:	. filing	01	modify:

GVM	Indramat MTC 200	customer:	
Vakuum Tisch	drill-bit gauging	Xynatech	
Westwind D1296	Hanbediengerät EBG 2	.	
Meßtaster	synchron Linearantriebe, DIAX04	New Mexico	

voltage supply
FC
circuit diagram



E. Wessel GmbH & Co.KG
electr. produk. equip.
Tel.: D - 05231/9663-0
32758 Delmold Farbenweg 6

= Rack	sheet 13
+ GVM	
	72 sh.

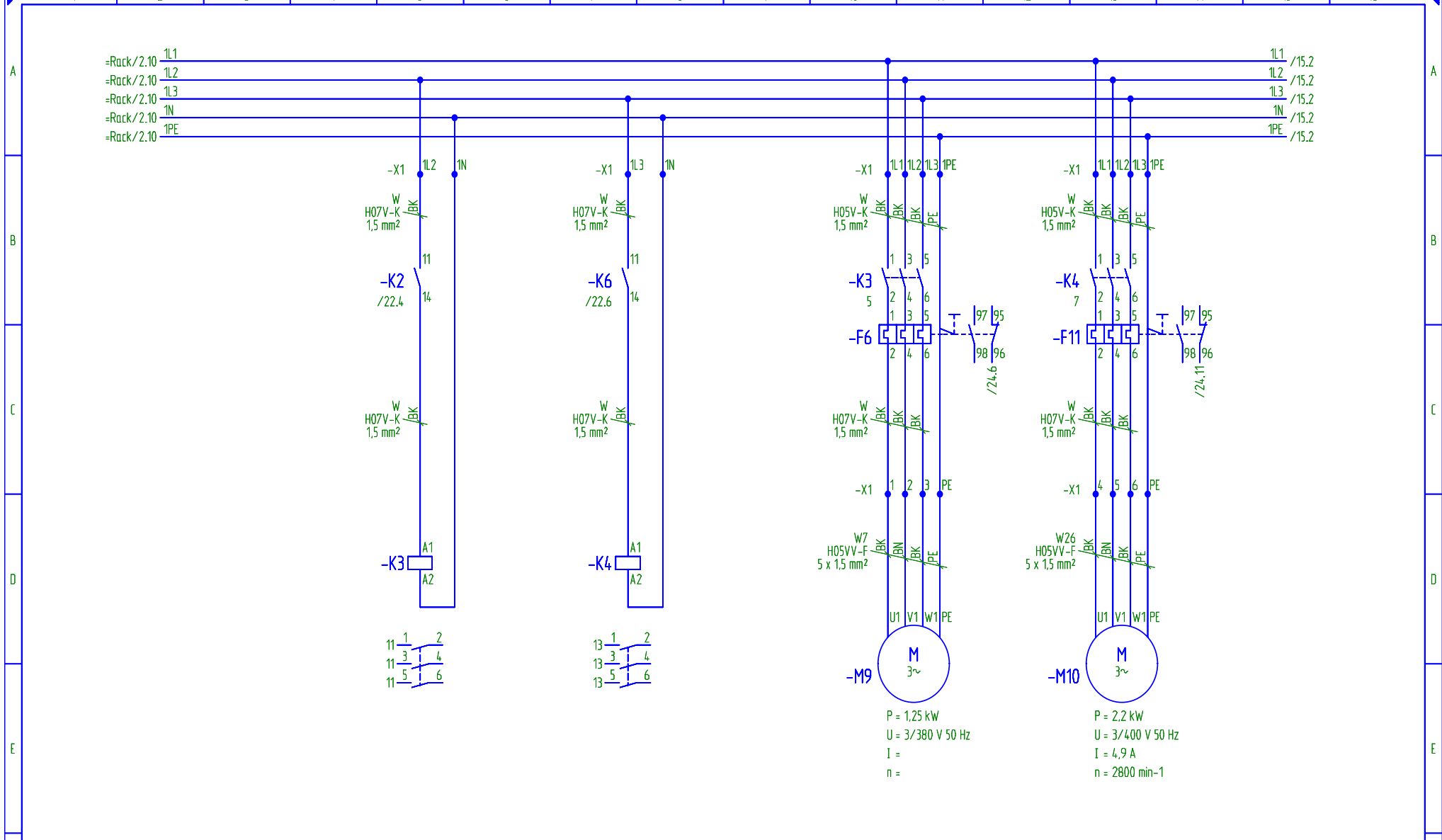

Vakuum Pumpe

vacuum unit

Vakuum Pumpe

vacuum unit

order no.:	29.026	date:	15.09.1999
mach.no.:	990820	drawer:	A. Könnemann
KS-file:	50990820.PRO	modify no.:	
d. carrier:		filing	01

GVM	Indramat MTC 200
Vakuum Tisch	drill-bit gauging
Westwind D1296	Hanbediengerät EBG 2
Meßtaster	synchron Linearantriebe, DIAX04

customer:	Xynatech
	New Mexico

**Leistungsversorgung
Vakuum Pumpe**
circuit diagram



E. Wessel GmbH & Co.KG
electr. produk. equip.
Tel.: D - 05231/9663-0
32758 Detmold Farbenweg 6

= electro	
+ GVM	sheet 14
	72 st.

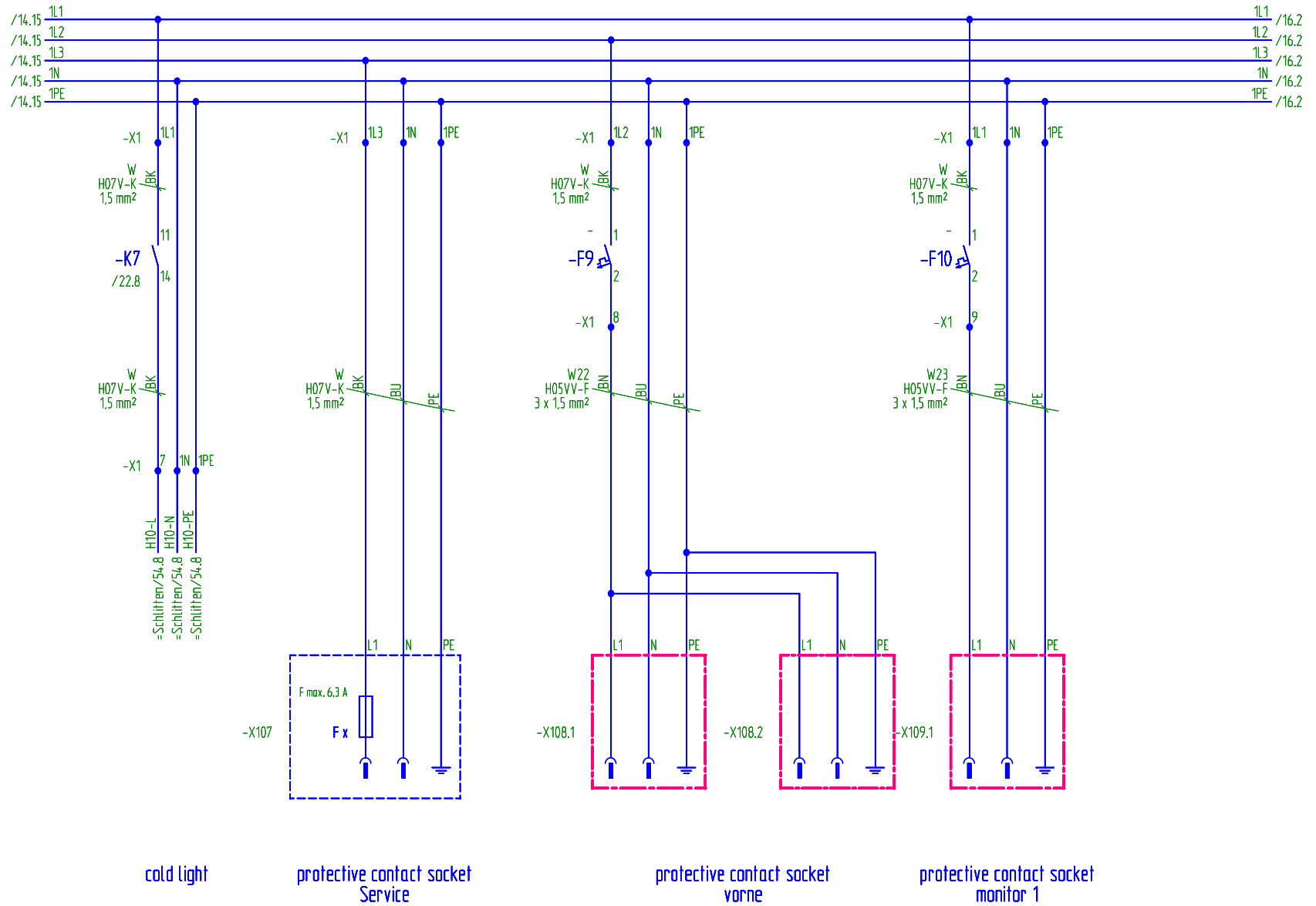

order no.:	29.026	date:	15.09.1999
mach.no.:	990820	drawer:	A. Käsemann
KS-file:	50990820.PRO	modify no.:	
d. carrier:		filing:	01

GVM
 Vakuu Tisch
 Westwind D1296
 Meßtaster

Indramat MTC 200
 drill-bit gauging
 Handbediengerät EBG 2
 synchron Linearantriebe, DIAX04

customer:
 Xynatech
 New Mexico

voltage supply
Maschinenbeleuchtung
 circuit diagram



E. Wessel GmbH & Co.KG
 electr. produk. equip.
 Tel.: D - 05231/9663-0
 32758 Detmold, Farbenweg 6

= electro	sheet 15
+ GVM	
	72 st.

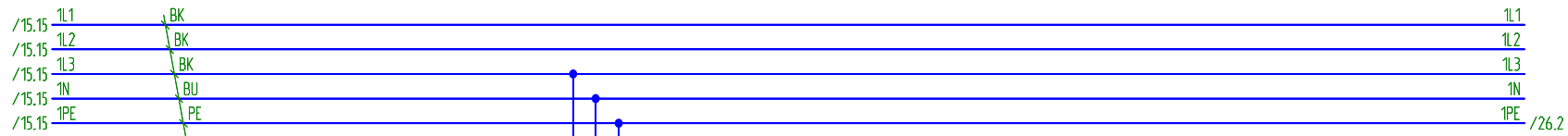

W
HO7V-K
2,5 mm²



W
HO5V-K
1,5 mm²

W
HO5V-K
0,75 mm²

W
HO5V-K
0,75 mm²

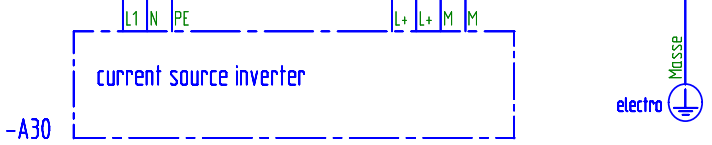

$U_E = 230 \text{ VAC } 1\text{Ph./N/PE}$
 $U_A = 24 \text{ VDC } +/-3\%$
 $I_A = 0-5 \text{ A}$
 Fuse= F 4 A / 250 V

order no.:	29.026	date:	15.09.1999
mach.no.:	990820	drawer:	A. Könnemann
KS-file:	50990820.PRO	modify no.:	
d. carrier:		filing:	01

GVM
 Vakuu Tisch
 Westwind D1296
 Meßtaster

Indramat MTC 200
 drill-bit gauging
 Handbediengerät EBG 2
 synchron Linearantriebe, DIAXQ4

customer:
 Xynatech
 New Mexico

voltage supply 24 V
 circuit diagram



E. Wessel GmbH & Co.KG
 electr. produk. equip.
 Tel.: D - 05231/9663-0
 32758 Detmold, Farbenweg 6

= electro	sheet 16
+ GVM	
	72 sh.

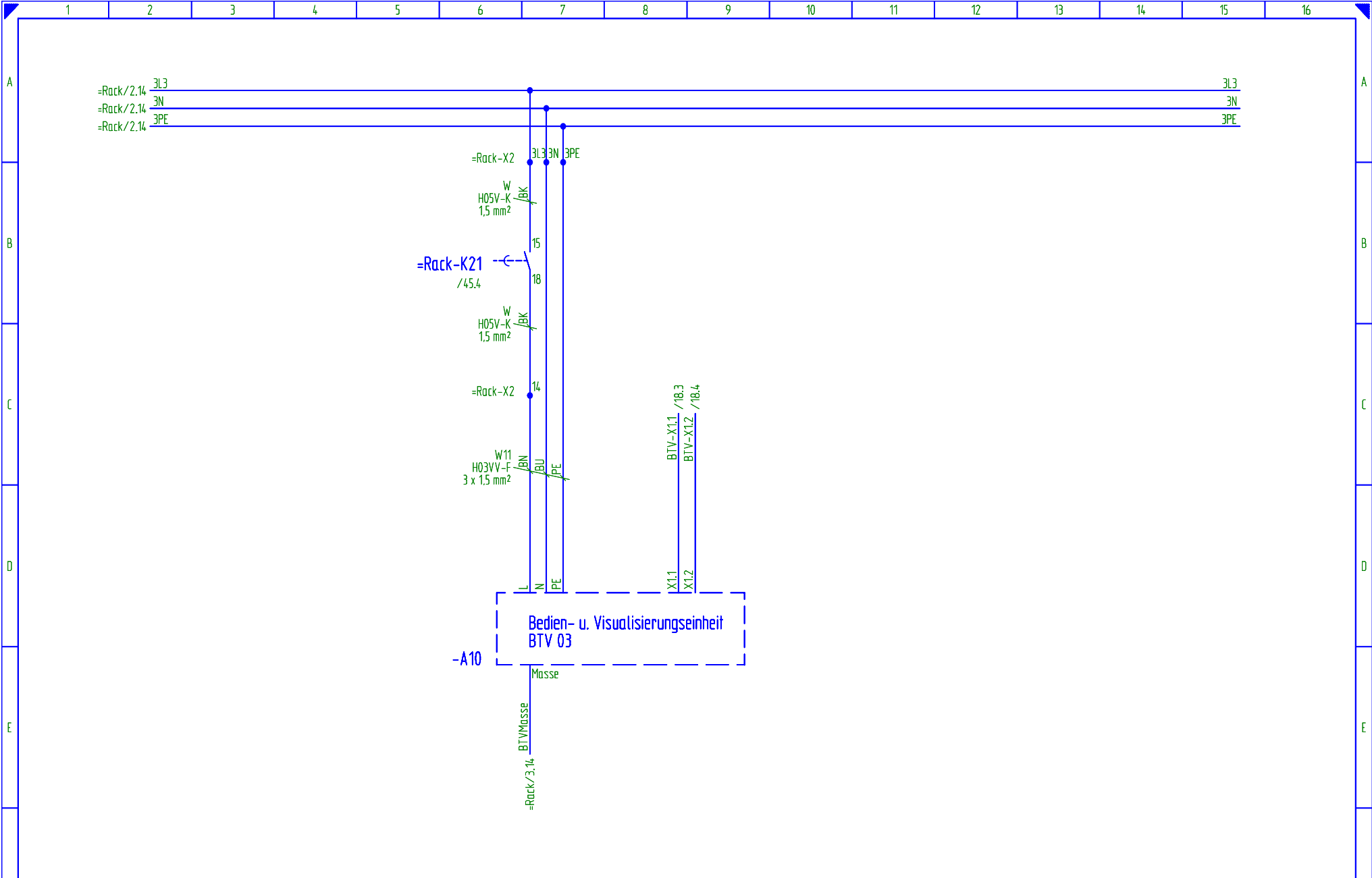

order no.:	29.026	date:	15.09.1999
mach.no.:	990820	drawer:	A. Könnemann
KS-file:	50990820.PRO	modify no.:	
d. carrier:	. filing	01	modify:

GVM
 Vakuu Tisch
 Westwind D1296
 Meßtaster

Indramat MTC 200
 drill-bit gauging
 Handbediengerät EBG 2
 synchron Linearantriebe, DIAX04

customer:
 Xynatech
 New Mexico

Bedieneinheit
Achsprozessor-Baustein
 circuit diagram



E. Wessel GmbH & Co.KG
 electr. produk. equip.
 Tel.: D - 05231/9663-0
 32758 Detmold, Farbenweg 6

= BTV-03	sheet 17
+ GVM	72 sh.

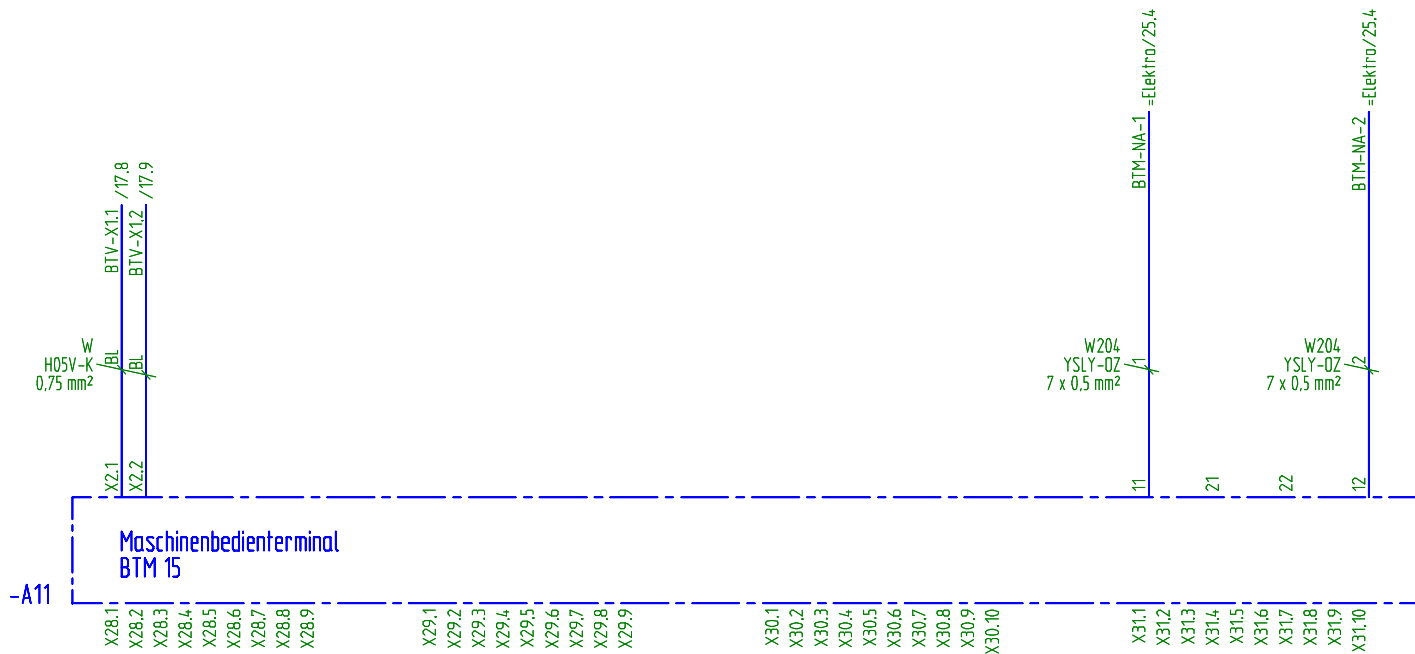

order no.:	29.026	date:	15.09.1999
mach.no.:	990820	drawer:	A. Könnemann
KS-file:	50990820.PRO	modify no.:	
d. carrier:	. filing	01	modify:

GVM
 Vakuu Tisch
 Westwind D1296
 Meßtaster

Indramat MTC 200
 drill-bit gauging
 Hanbediengerät EBG 2
 synchron Linearantriebe, DIAXQ4

customer:
 Xynatech
 New Mexico

**Maschinenbedienterminal
 BTM 15**
 circuit diagram

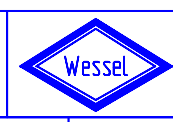

E. Wessel GmbH & Co.KG
 electr. produk. equip.
 Tel.: D - 05231/9663-0
 32758 Detmold Farbenweg 6

= BTV-03 + GVM	sheet 18
	72 sh.

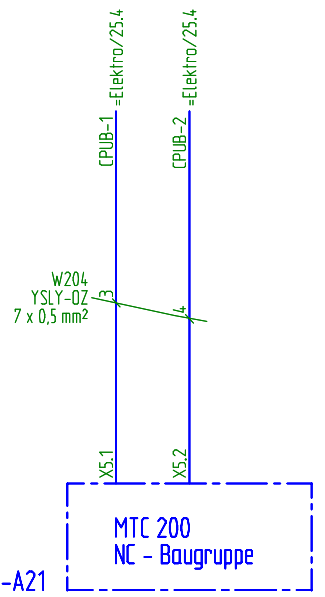

order no.:	29.026	date:	15.09.1999
mach.no.:	990820	drawer:	A. Könnemann
XS-file:	50990820.PRO	modify no.:	
d. carrier:	. filing 01	modify:	

GVM
 Vakuum Tisch
 Westwind D1296
 Meßtaster

Indramat MTC 200
 drill-bit gauging
 Handbediengerät EBG 2
 synchron Linearantriebe, DIAX04

customer:
 Xynatech
 New Mexico

MTC 200
NC-Baugruppe
 circuit diagram



E. Wessel GmbH & Co.KG
 electr. produk. equip.
 Tel.: D - 05231/9663-0
 32758 Detmold Farbenweg 6

= BTV-03
+ GVM
sheet 19
72 sh.

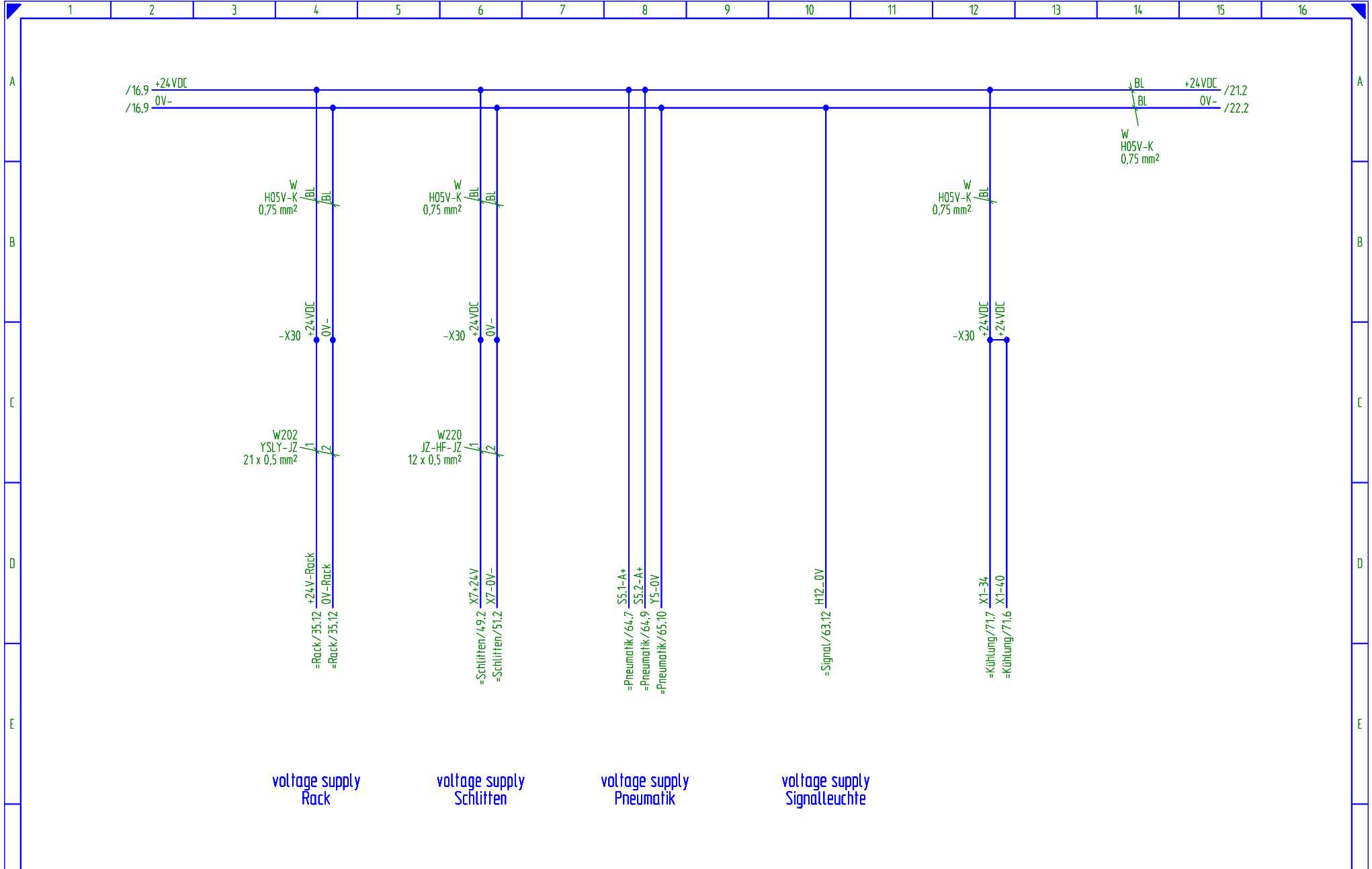

voltage supply
Rack

voltage supply
Schlitten

voltage supply
Pneumatik

voltage supply
Signalleuchte

order no.:	29.026	date:	15.09.1999
mach.no.:	990820	drawer:	A. Könnemann
KS-file:	50990820.PRO	modify no.:	
d. carrier:		modify:	

GVM
Vakuum Tisch
Westwind D1296
Meßtaster

Indramat MTC 200
drill-bit gauging
Hanbediengerät EBG 2
synchron Linearantriebe, DIAXQ4

customer:
Xynatech
New Mexico

voltage supply 24 V
circuit diagram



E. Wessel GmbH & Co.KG
electr. produk. equip.
Tel.: D - 05231/9663-0
32758 Delmold Farbenweg 6

= electro	
+ GVM	sheet 20
	72 sh.

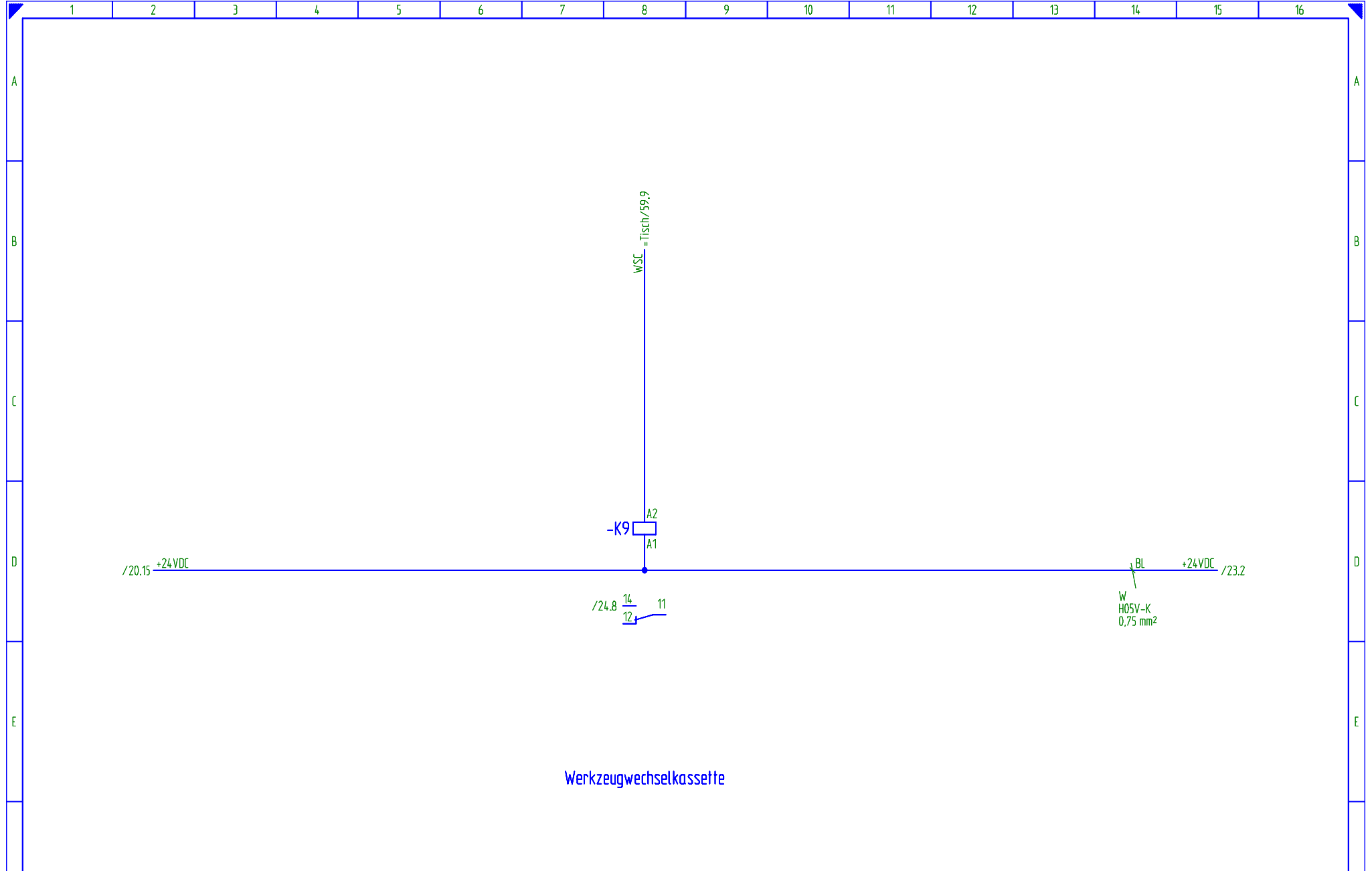

Werkzeugwechselkassette

order no.:	29.026	date:	15.09.1999	GVM	Indramat MTC 200	customer:	Interface-Relais			E. Wessel GmbH & Co.KG	= electro
mach.no.:	990820	drawer:	A. Könnemann	Vakuum Tisch	drill-bit gauging	Xynatech	circuit diagram			electr. produk. equip.	+ GVM
KS-file:	50990820.PRO	modify no.:		Westwind D1296	Hanbediengerät EBG 2	.				Tel.: D - 05231/9663-0	sheet 21
d. carrier:	. filing 01	modify:		Meßtaster	synchron Linearantriebe, DIAXQ4	New Mexico			32758 Detmold Farbenweg 6	72 st.	

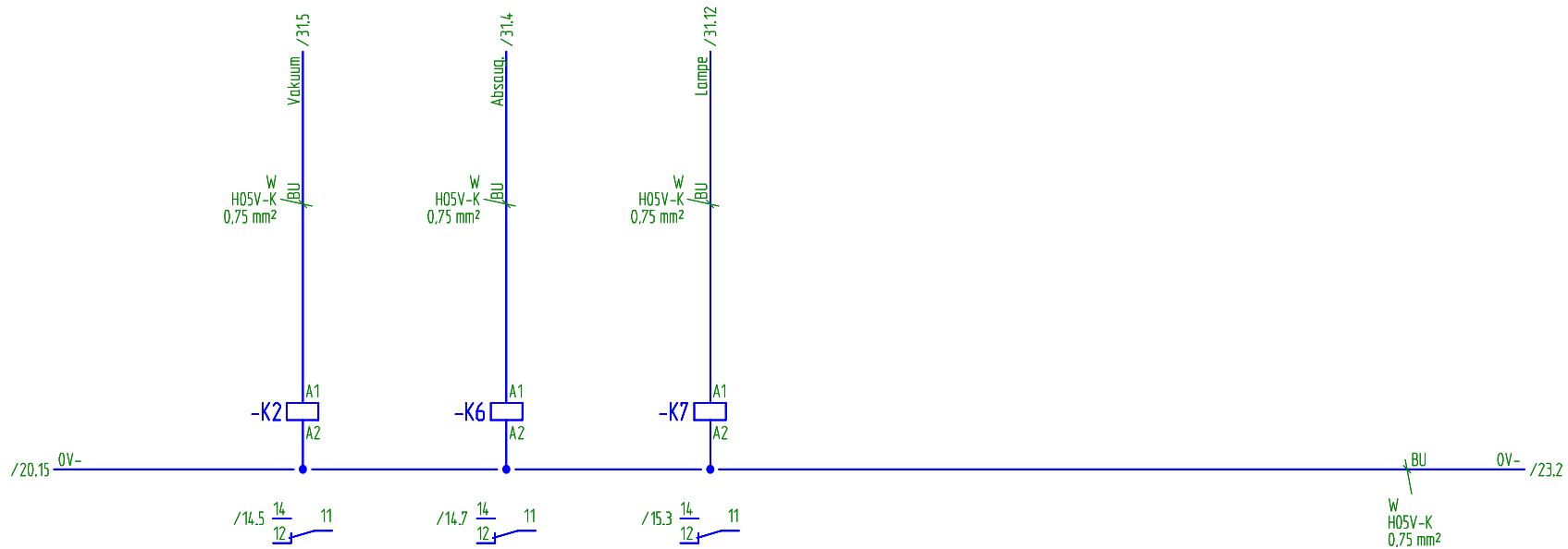

Vakuum-Pumpe

vacuum unit

cold light

order no.:	29.026	date:	15.09.1999
mach.no.:	990820	drawer:	A. Könnemann
KS-file:	50990820.PRO	modify no.:	
d. carrier:	. filing 01	modify:	

GVM	Indramat MTC 200
Vakuum Tisch	drill-bit gauging
Westwind D1296	Hanbediengerät EBG 2
Meßtaster	synchron Linearantriebe, DIAX04

customer:	Xynatech
	New Mexico

Interface-Relais

circuit diagram



E. Wessel GmbH & Co.KG
 electr. produk. equip.
 Tel.: D - 05231/9663-0
 32758 Delmold Farbenweg 6

= electro
+ GVM
sheet 22
72 st.

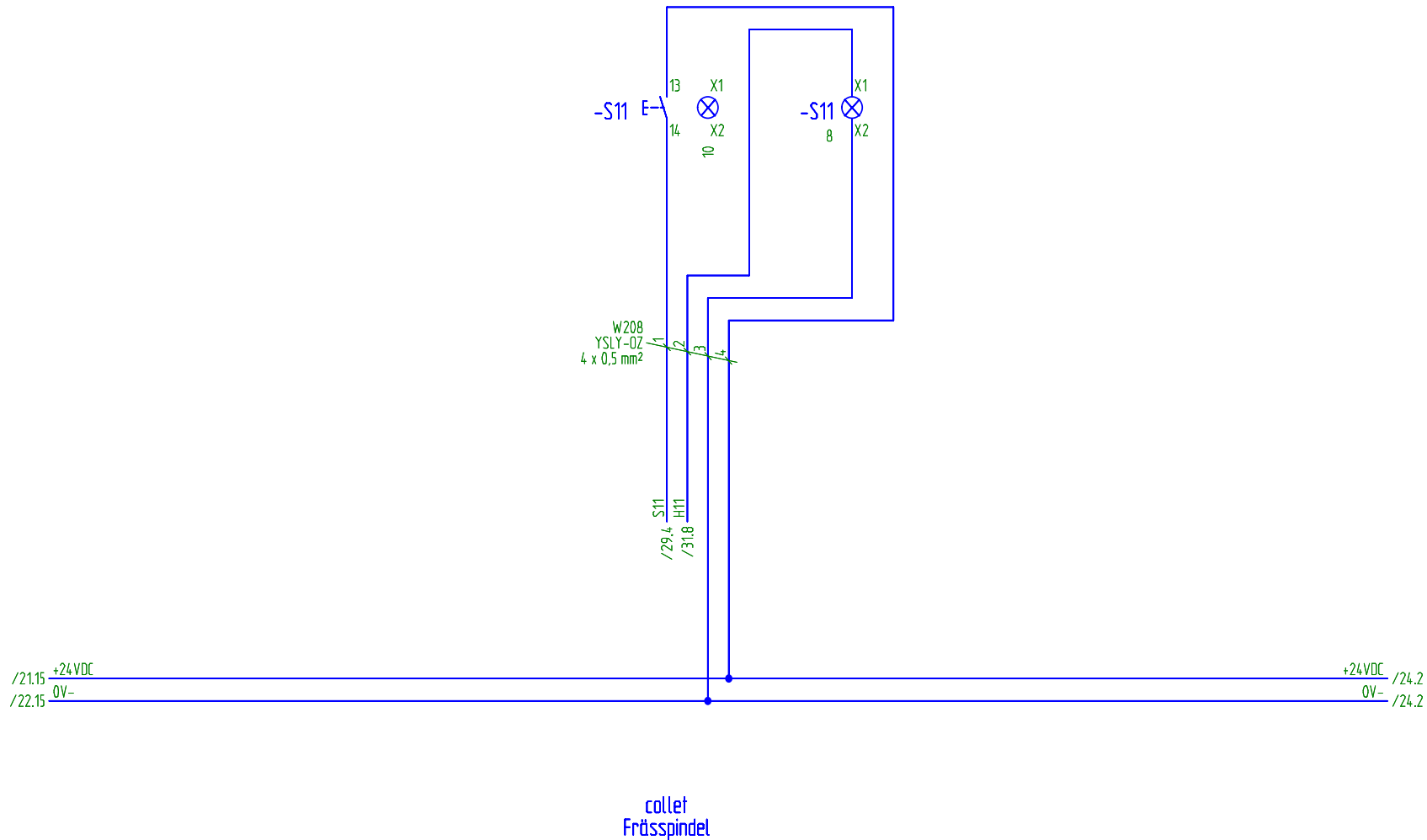

order no.:	29.026	date:	15.09.1999
mach.no.:	990820	drawer:	A. Könnemann
KS-file:	50990820.PRO	modify no.:	
d. carrier:	.	filing	01

GVM
 Vakuu Tisch
 Westwind D1296
 Meßtaster

Indramat MTC 200
 drill-bit gauging
 Handbediengerät EBG 2
 synchron Linearantriebe, DIAX04

customer:
 Xynatech
 New Mexico

Schalter
Spannzange Frässpindel
 circuit diagram



E. Wessel GmbH & Co.KG
 electr. produk. equip.
 Tel.: D - 05231/9663-0
 32758 Detmold, Farbenweg 6

= electro	sheet23
+ GVM	72 sh.

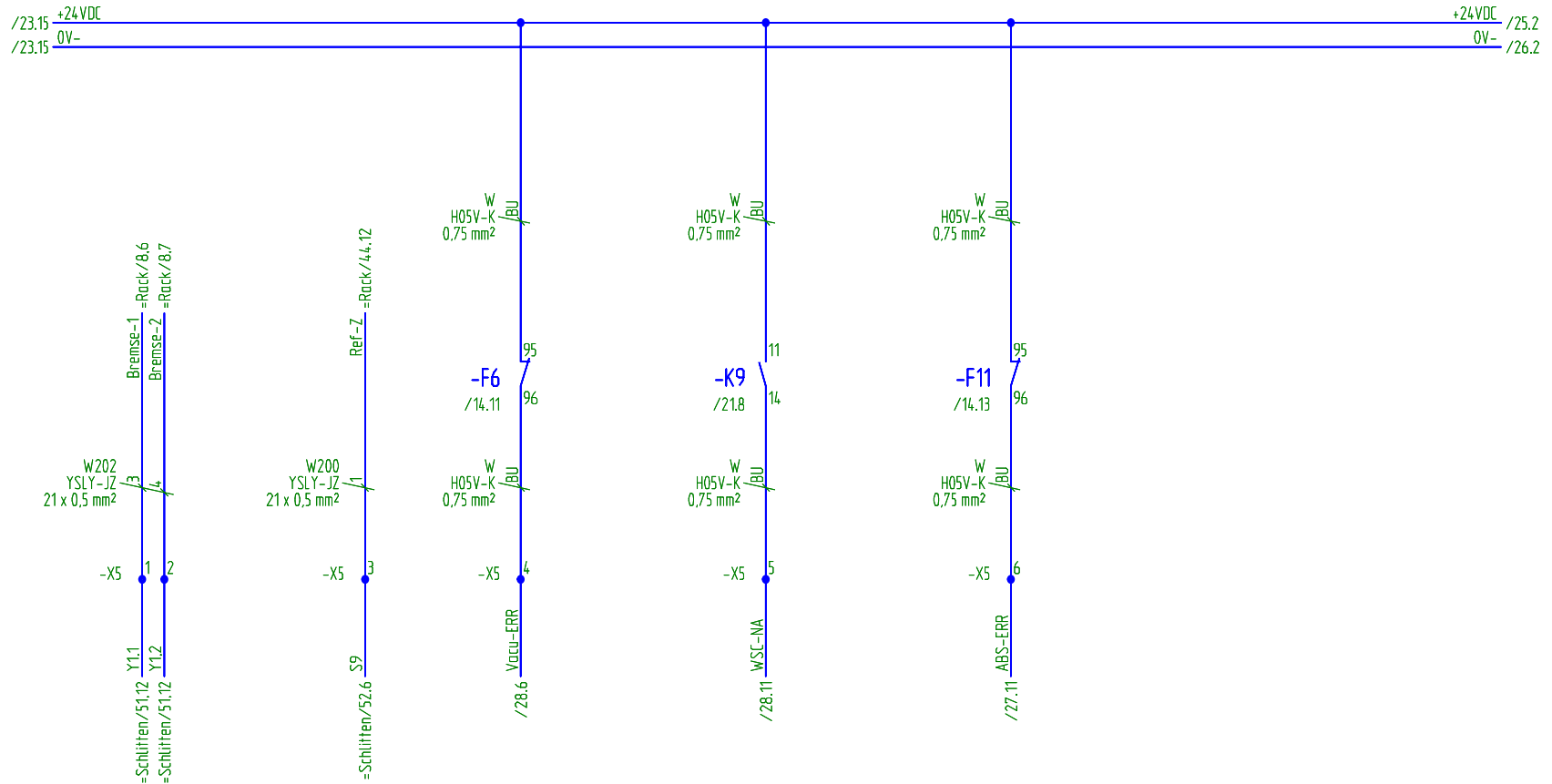

Oberstromrelais
Vakuum-Pumpe

Werkzeugwechselkassette

Oberstromrelais
vacuum unit

order no.:	29.026	date:	15.09.1999
mach.no.:	990820	drawer:	A. Könnemann
XS-file:	50990820.PRO	modify no.:	
d. carrier:	. filing	01	modify:

GVM	Indramat MTC 200
Vakuum Tisch	drill-bit gauging
Westwind D1296	Hanbediengerät EBG 2
Meßtaster	synchron Linearantriebe, DIAX04

customer:	Xynatech
	New Mexico

Werkzeugwechselkassette
circuit diagram



E. Wessel GmbH & Co.KG
electr. produk. equip.
Tel.: D - 05231/9663-0
32758 Detmold Farbenweg 6

= electro
+ GVM
sheet 24
72 sh.

/24.15 +24VDC

+24VDC /26.2

W
H05V-K
0,75 mm²
/BL

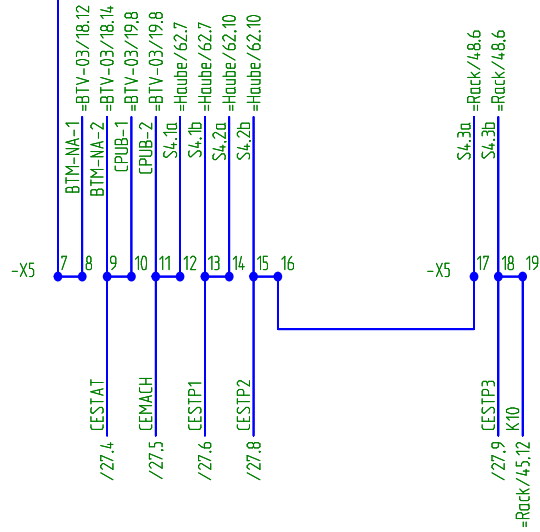

order no.:	29.026	date:	15.09.1999
mach.no.:	990820	drawer:	A. Könnemann
XS-file:	50990820.PRO	modify no.:	
d. carrier:	. filing 01	modify:	

GVM
Vakuu Tisch
Westwind D1296
Meßtaster

Indramat MTC 200
drill-bit gauging
Hanbediengerät EBG 2
synchron Linearantriebe, DIAX04

customer:
Xynatech
New Mexico

control switch
circuit diagram



E. Wessel GmbH & Co.KG
electr. produk. equip.
Tel.: D - 05231/9663-0
32758 Detmold Farbenweg 6

= electro	sheet 25
+ GVM	
	72 sh.

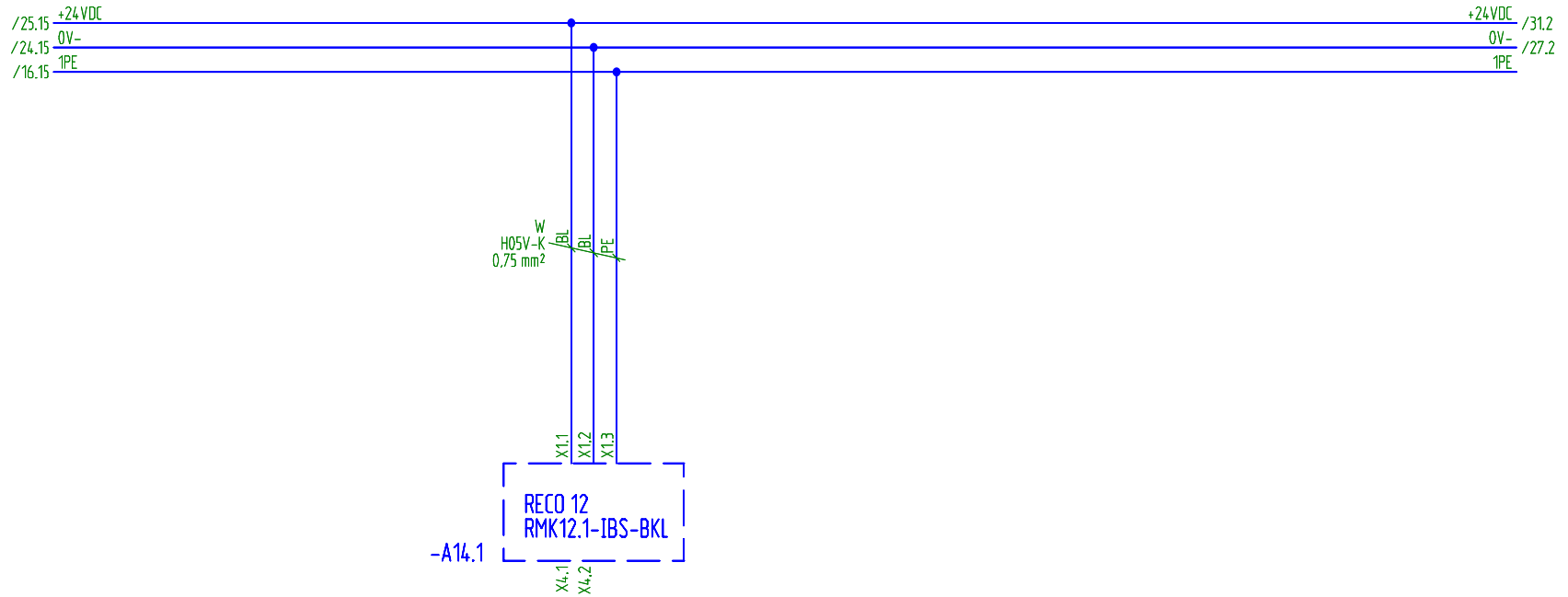

order no.:	29.026	date:	15.09.1999
mach.no.:	990820	drawer:	A. Könnemann
KS-file:	50990820.PRO	modify no.:	
d. carrier:	. filing	01	modify:

GVM
 Vakuum Tisch
 Westwind D1296
 Meßtaster

Indramat MTC 200
 drill-bit gauging
 Handbediengerät EBG 2
 synchron Linearantriebe, DIAXQ4

customer:
 Xynatech
 New Mexico

InterBus-S - Buskoppelmodul
RECO 12
 circuit diagram



E. Wessel GmbH & Co.KG
 electr. produk. equip.
 Tel.: D - 05231/9663-0
 32758 Delmold Farbenweg 6

= electro	
+ GVM	sheet 26
	72 sh.

/26.15 OV- /28.2 OV-

H05V-K
0,75 mm²
W
/BU

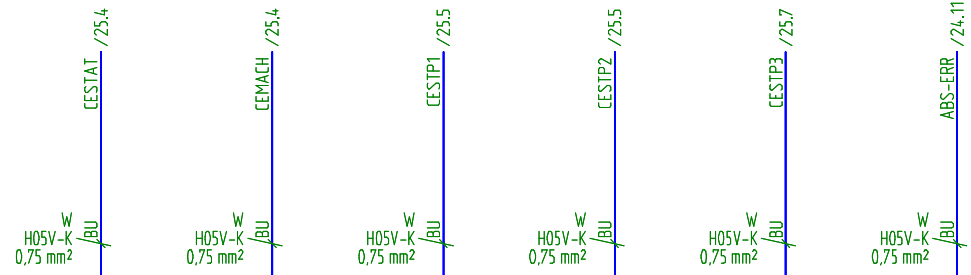

bitadress: .0 .1 .2 .3 .4 .5 .6 .7 .8 .9 OVL

InterBus-S Eingangsmodul

refer /28.2 Stecker: X1

RME12.1-32-DC024

-A12.1

(*PB Not-Aus BTM 15*)

(*NC-Einschub BTV 03*)

(*PB Not-Aus 2 Maschine*)

(*PB Not-Aus 3 Maschine*)

(*PB Not-Aus 4 Steuerung*)

(*Thermokontakt Absaugung*)

order no:	29.026	date:	15.09.1999
mach.no.:	990820	drawer:	A. Könnemann
KS-file:	50990820.PRO	modify no.:	
d. carrier:		modify:	

GVM	Indramat MTC 200	customer:	Xynatech
Vakuum Tisch	drill-bit gauging		
Westwind D1296	Hanbediengerät EBG 2		
Meßtaster	synchron Linearantriebe, DIAX04		New Mexico

InterBus-S - Eingangsmodul
Byte 3
circuit diagram



E. Wessel GmbH & Co.KG
electr. produk. equip.
Tel.: D - 05231/9663-0
32758 Detmold Farbenweg 6

= electro	sheet 27
+ GVM	
	72 sh.

1 2 3 4 5 6 7 8 9 10 11 12 13 14 15 16

A /27.15 OV- OV- /29.2

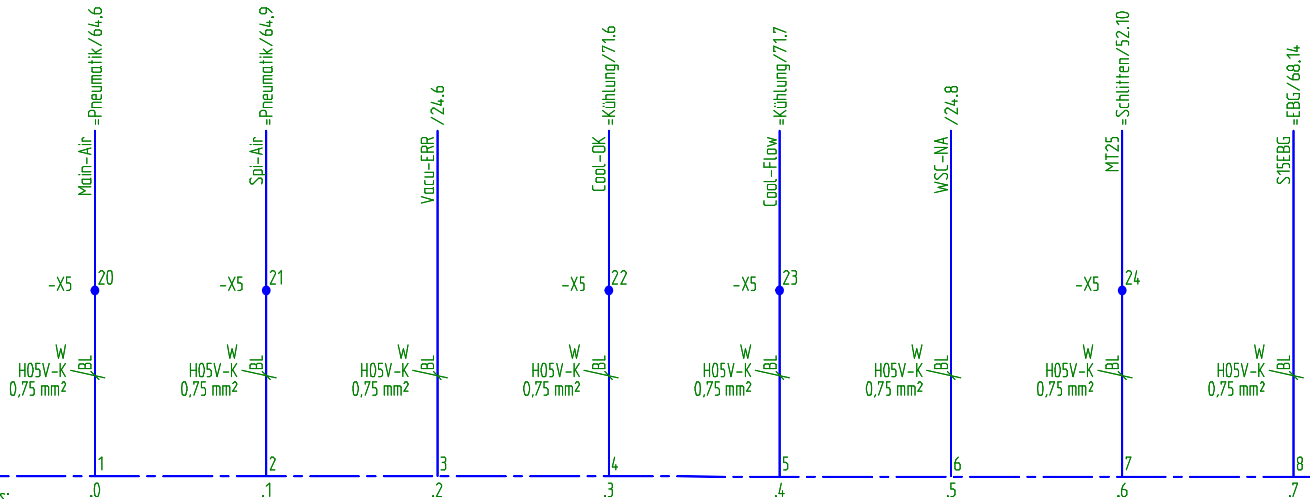

InterBus-S Eingangsmodul

refer /27.2 Stecker: X2

RME12.1-32-DC024

-A12.1

- (*) Druckschalter Hauptluft(*)
- (*) Druckschalter Spindelluft(*)
- (*) Thermokontakt Vakuumpumpe(*)
- (*) Kuehlsystem betriebsbereit(*)
- (*) Kuehlsystem Flusswaechter OK(*)
- (*) Werkzeugwechselkassette(*)
- (*) Messtaster oben(*)
- (*) EBG Optik Ein/Aus(*)

order no.:	29.026	date:	15.09.1999
mach.no.:	990820	drawer:	A. Könnemann
KS-file:	50990820.PRO	modify no.:	
d. carrier:		modify:	

GVM
 Vakuu Tisch
 Westwind D1296
 Meßtaster

Indramat MTC 200
 drill-bit gauging
 Handbediengerät EBG 2
 synchron Linearantriebe, DIAX04

customer:
 Xynatech
 New Mexico

InterBus-S - Eingangsmodul
 Byte 2
 circuit diagram



E. Wessel GmbH & Co.KG
 electr. produk. equip.
 Tel.: D - 05231/9663-0
 32758 Detmold, Farbenweg 6

= electro	sheet 28
+ GVM	
	72 st.

/28.15 OV- /30.2 OV-

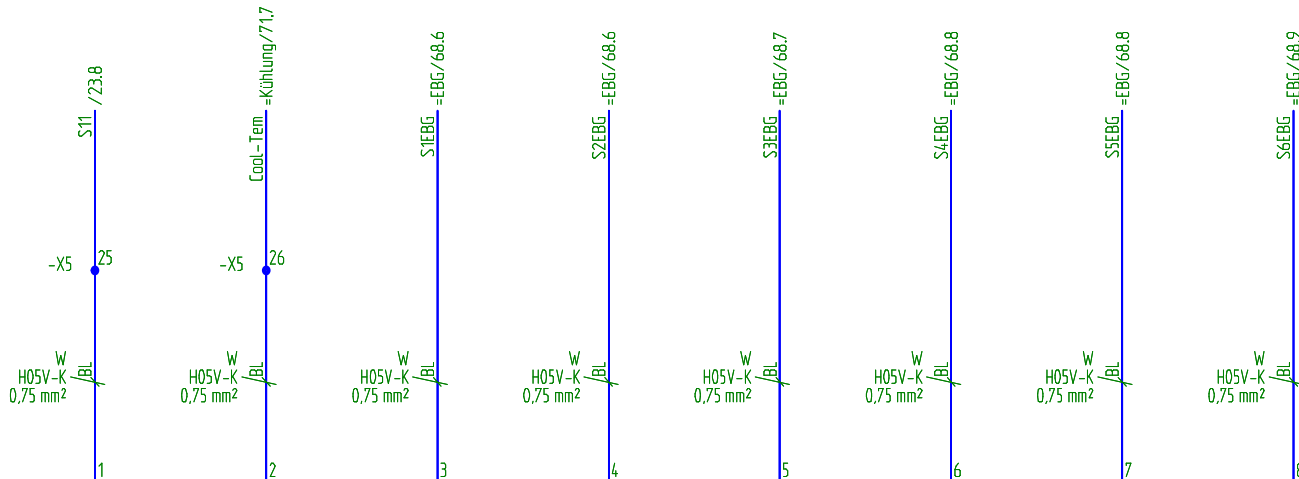

bitaddress: 0 1 2 3 4 5 6 7 9 OVL

InterBus-S Eingangsmodul

refer /30.2 Stecker: X3 RME12.1-32-DC024

-A12.1

- (*Spannzange Fraesspindel*)
- (*Kuehlsystem Temperatur OK*)
- (*EBG Vorschub 10%*)
- (*EBG Y-Achse Y***)
- (*EBG Vorschub 100%*)
- (*EBG X-Achse X***)
- (*EBG Isterfte nullen*)
- (*EBG X-Achse X-*)

order no:	29.026	date:	15.09.1999
mach.no.:	990820	drawer:	A. Koenemann
KS-file:	50990820.PRO	modify no.:	02
d. carrier:	.	filing:	01
		modify:	02.04.98

GVM
 Indramat MTC 200
 Vakuu Tisch
 Westwind D1296
 Meßtaster
 synchron Linearantriebe, DIAX04

customer:
 Xynatech
 New Mexico

InterBus-S - Eingangsmodul
 Byte 1
 circuit diagram



E. Wessel GmbH & Co.KG
 electr. produk. equip.
 Tel.: D - 05231/9663-0
 32758 Detmold Farbenweg 6

= electro	sheet 29
+ GVM	
	72 sh.

/29.15 0V- /31.2 0V-

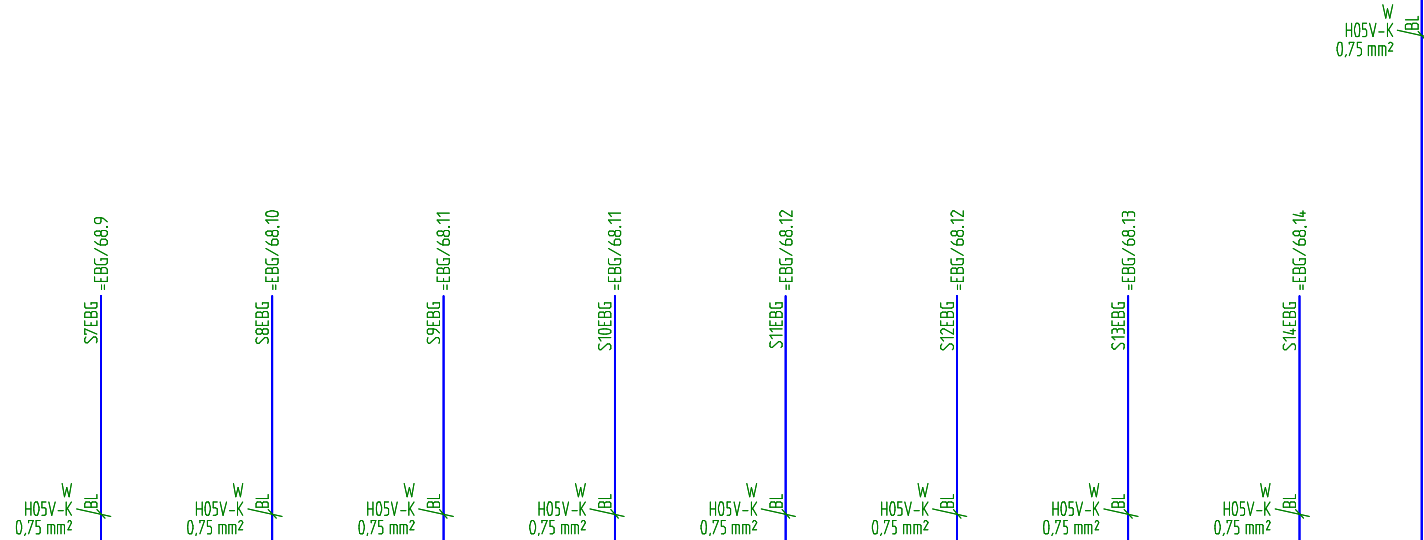

bitaddress: .0 .1 .2 .3 .4 .5 .6 .7 0VL

InterBus-S Eingangsmodul

refer /29.2 Stecker: X4 RME12.1-32-DC024

-A12.1

(*EBG Automatikbetrieb*)

(*EBG Y-Achse Y-*)

(*EBG Handbetrieb*)

(*EBG Automatik Start*)

(*EBG Kontinuierlich*)

(*EBG Eingang*)

(*EBG Automatik Stop*)

(*EBG Messtaster runter*)

order no.:	29.026	date:	15.09.1999
mach.no.:	990820	drawer:	A. Könnemann
KS-file:	50990820.PRO	modify no.:	02
d. carrier:	. filing	01	modify:
			02.04.98

GVM
 Vakuum Tisch
 Westwind D1296
 Meßtaster

Indramat MTC 200
 drill-bit gauging
 Handbediengerät EBG 2
 synchron Linearantriebe, DIAX04

customer:
 Xynatech
 New Mexico

InterBus-S - Eingangsmodul
 Byte 0
 circuit diagram



E. Wessel GmbH & Co.KG
 electr. produk. equip.
 Tel.: D - 05231/9663-0
 32758 Detmold Farbenweg 6

= electro	sheet 30
+ GVM	
	72 sh.

/26.15 +24 VDC
/30.15 0V-

+24 VDC /32.2
0V- /32.2

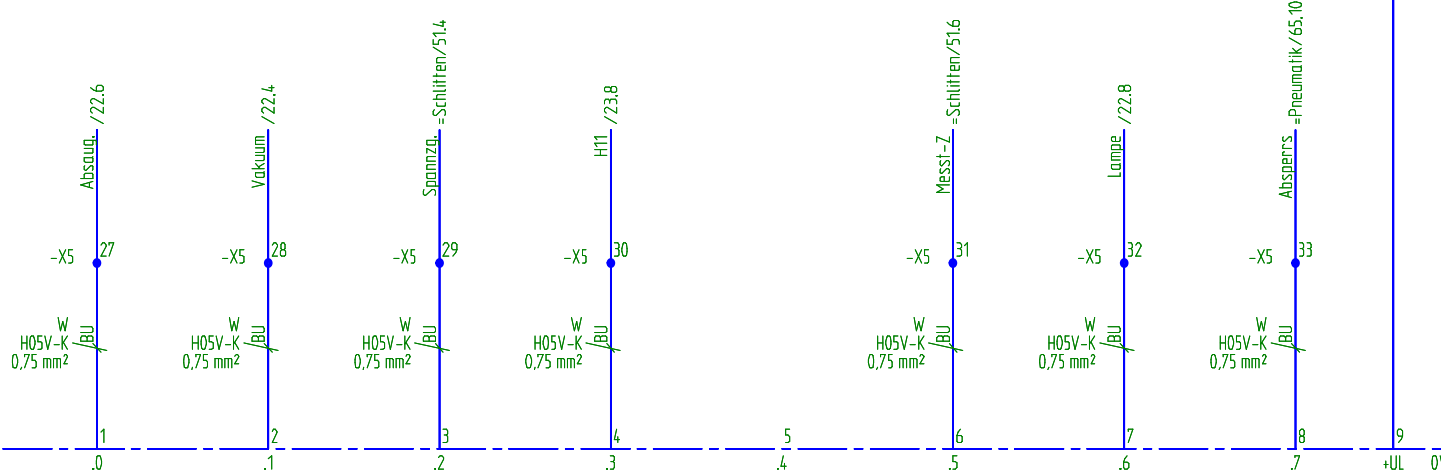

InterBus-S Ausgangsmodul

refer /32.2

Stecker: X1

RMA12.1-32-DC024-200

-A13.1

(*Absaugung Ein*)

(*Vakuumpumpe EIN*)

(*Spannzange Spindel auf*)

(*Leichtmelder Spannzange*)

(*Messfahnen TM25P*)

(*Kaltlichtquelle Ein*)

(*Absperrschieber Auf*)

order no.:	29.026	date:	15.09.1999
mach.no.:	990820	drawer:	A. Könnemann
KS-file:	50990820.PRO	modify no.:	02
d. carrier:	.	filing:	01
		modify:	02.04.98

GVM	Indramat MTC 200	customer:	
Vakuumpumpe	drill-bit gauging	Xynatech	
Westwind D1296	Handbediengerät EBG 2		
Messtaster	synchron Linearantriebe, DIAX04	New Mexico	

InterBus-S - Ausgangsmodul	
Byte 3	
circuit diagram	



E. Wessel GmbH & Co.KG
electr. produk. equip.
Tel.: D - 05231/9663-0
32758 Detmold Farbenweg 6

= electro
+ GVM
sheet 31
72 sh.

/31.15 +24VDC
/31.15 0V-

+24VDC /33.2
0V- /33.2

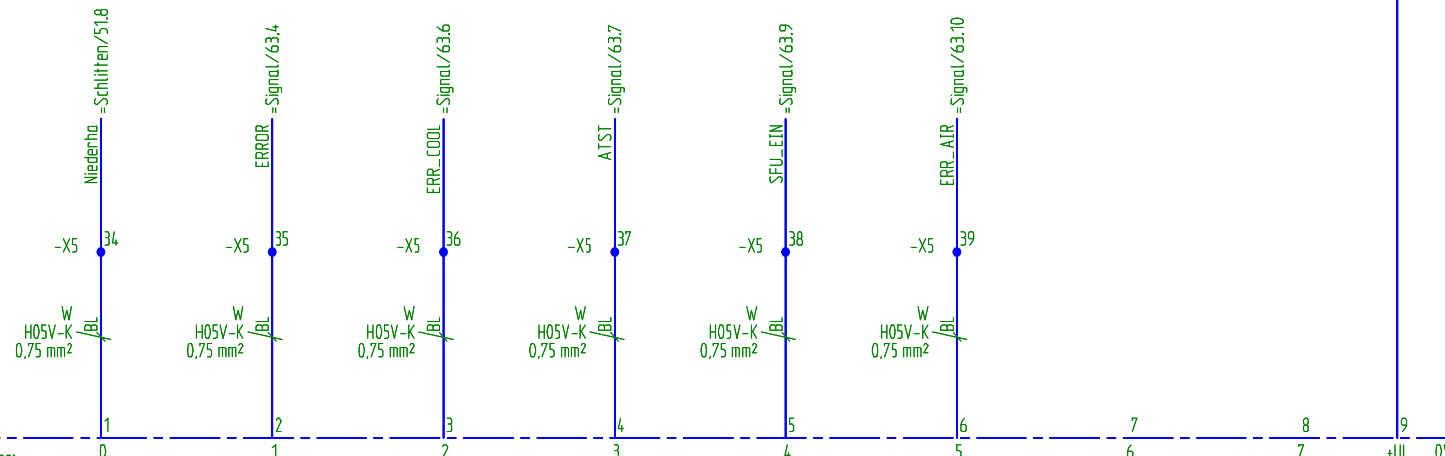

InterBus-S Ausgangsmodul

refer /31.2 Stecker: X2

RMA12.1-32-DC024-200

-A13.1

(*Niederhalter Rauf*)

(*Meldeteuchte Maschinenfehler*)

(*Meldeteuchte Fehl. Kühlung*)

(*Meldeteuchte AUTO Start*)

(*Meldeteuchte Spindel läuft*)

(*Meldeteuchte Fehl. Luftver.*)

order no.:	29.026	date:	15.09.1999
mach.no.:	990820	drawer:	A. Könnemann
KS-file:	50990820.PRO	modify no.:	
d. carrier:		filing:	01

GVM	Indramat MTC 200
Vakuum Tisch	drill-bit gauging
Westwind D1296	Hanbediengerät EBG 2
Meshtaster	synchron Linearantriebe, DIAX04

customer:	Xynatech
	New Mexico

InterBus-S - Ausgangsmodul
Byte 2
circuit diagram



E. Wessel GmbH & Co.KG
electr. produk. equip.
Tel.: D - 05231/9663-0
32758 Detmold Farbenweg 6

= electro
+ GVM
sheet 32
72 sh.

/32.15 +24 VDC
/32.15 0V-

+24 VDC /34.2
0V- /34.2

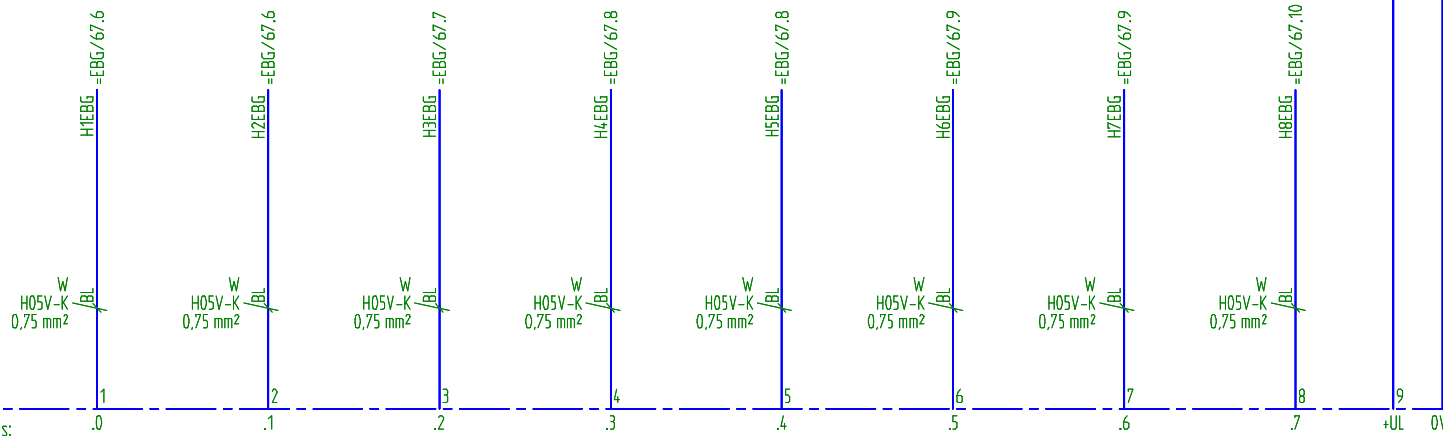

InterBus-S Ausgangsmodul

refer /34.2

Stecker: X3

RMA12.1-32-DC024-200

-A13.1

(*EBG Vorschub 10%*)

(*EBG Y-Achse Y+*)

(*EBG Vorschub 100%*)

(*EBG X-Achse X+*)

(*EBG Isterte nullen*)

(*EBG X-Achse X-*)

(*EBG Automatikbetrieb*)

(*EBG Y-Achse Y-*)

order no.:	29.026	date:	15.09.1999
mach.no.:	990820	drawer:	A. Könnemann
KS-file:	50990820.PRO	modify no.:	
d. carrier:		filing:	01

GVM	Indramat MTC 200
Vakuum Tisch	drill-bit gauging
Westwind D1296	Hanbediengerät EBG 2
Meßtaster	synchron Linearantriebe, DIAX04

customer:	Xynatech
	New Mexico

InterBus-S - Ausgangsmodul
Byte 1
circuit diagram



E. Wessel GmbH & Co.KG
electr. produk. equip.
Tel.: D - 05231/9663-0
32758 Detmold Farbenweg 6

= electro
+ GVM
sheet 33
72 sh.

/33.15 +24 VDC
/33.15 0V-

+24 VDC =Tisch/60.2
0V- =Rack/35.2

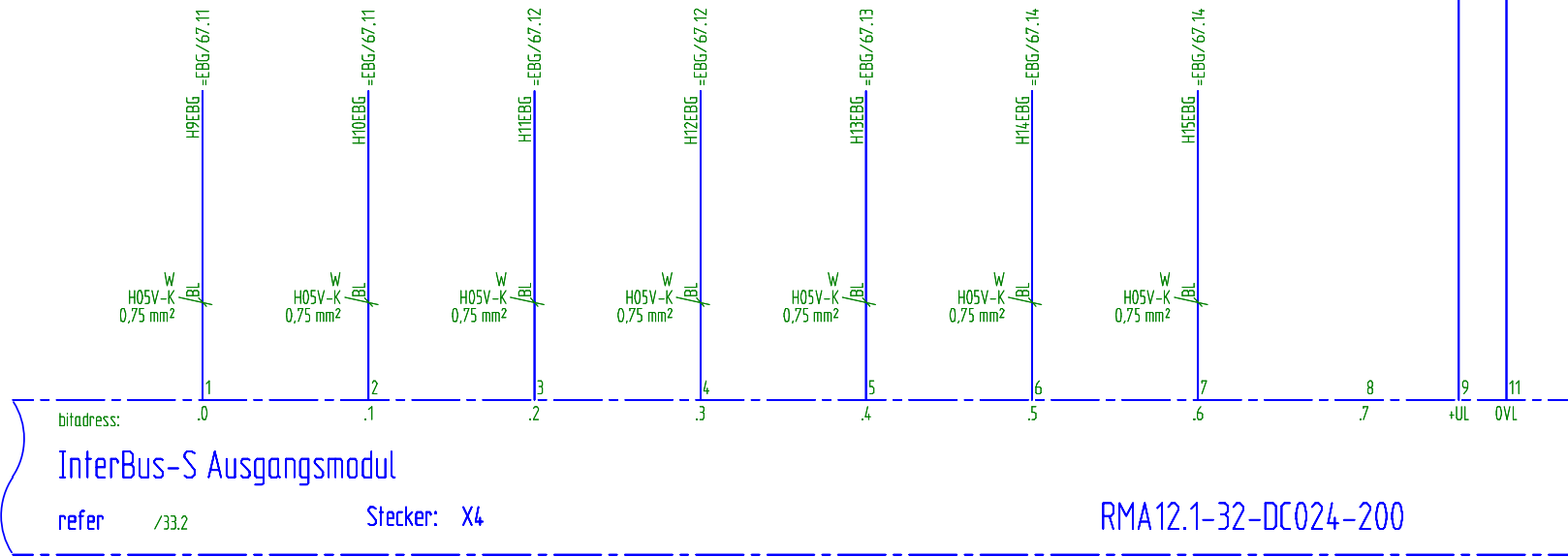

InterBus-S Ausgangsmodul

refer /33.2 Stecker: X4

RMA12.1-32-DC024-200

-A13.1

(*EBG Handbetrieb*)

(*EBG Automatik Start*)

(*EBG Kontinuierlich*)

(*EBG Eingang*)

(*EBG Automatik Stop*)

(*EBG Messtaster runter*)

(*EBG Optik Ein/Aus*)

order no.:	29.026	date:	15.09.1999
mach.no.:	990820	drawer:	A. Könnemann
KS-file:	50990820.PRO	modify no.:	
d. carrier:		filing:	01

GVM	Indramat MTC 200
Vakuum Tisch	drill-bit gauging
Westwind D1296	Handbediengerät EBG 2
Meßtaster	synchron Linearantriebe, DIAX04

customer:	Xynatech
	New Mexico

InterBus-S - Ausgangsmodul
Byte 0
circuit diagram



E. Wessel GmbH & Co.KG
electr. produk. equip.
Tel.: D - 05231/9663-0
32758 Detmold Farbenweg 6

= electro
+ GVM
sheet 34
72 sh.

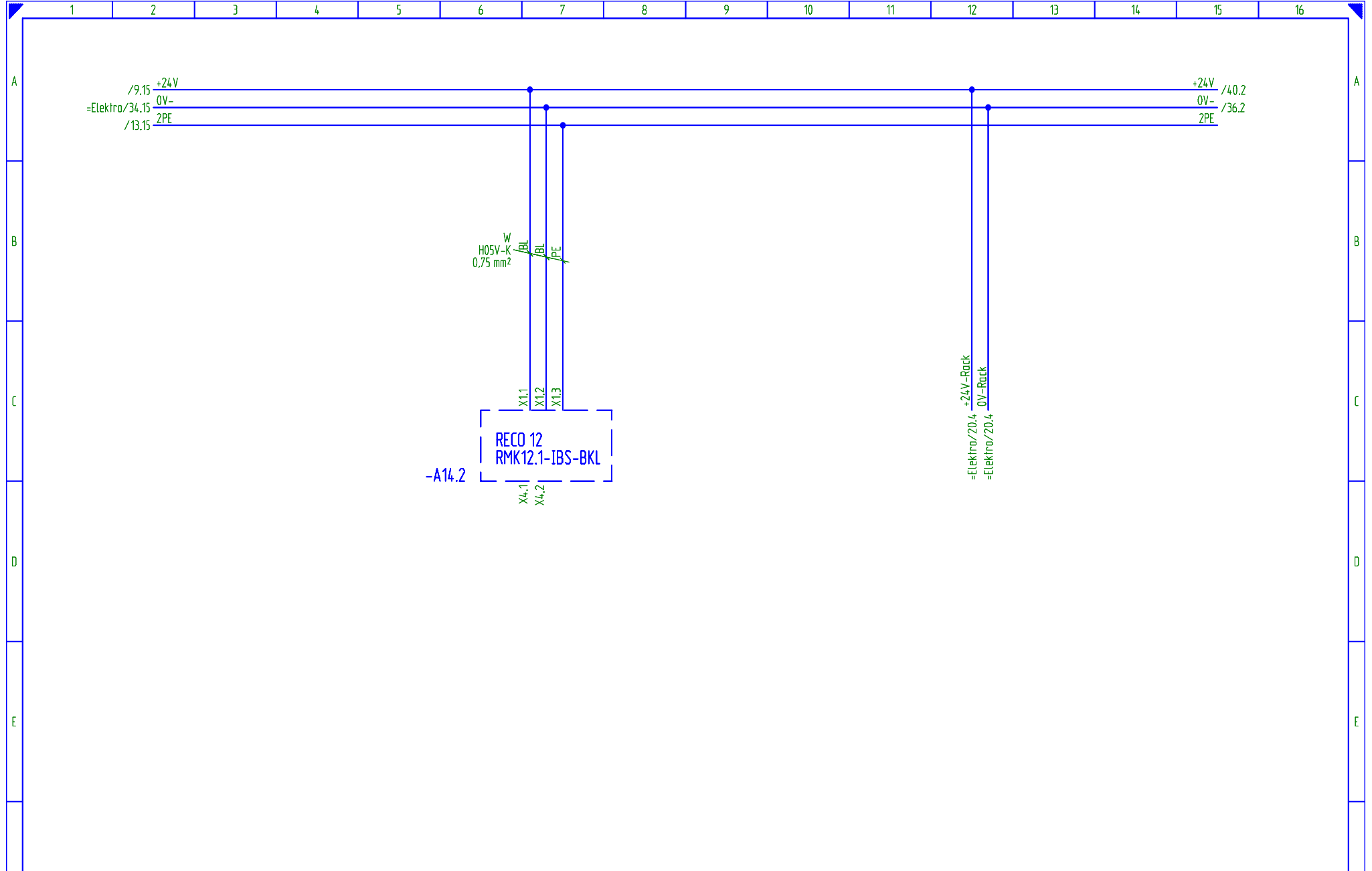

order no.:	29.026	date:	15.09.1999
mach.no.:	990820	drawer:	A. Könnemann
KS-file:	50990820.PRO	modify no.:	
d. carrier:	.	filing	01

GVM
 Vakuu Tisch
 Westwind D1296
 Meßtaster

Indramat MTC 200
 drill-bit gauging
 Handbediengerät EBG 2
 synchron Linearantriebe, DIAX04

customer:
 Xynatech
 New Mexico

InterBus-S - Buskoppelmodul
RECO 12
 circuit diagram



E. Wessel GmbH & Co.KG
 electr. produk. equip.
 Tel.: D - 05231/9663-0
 32758 Delmold Farbenweg 6

= Rack	sheet 35
+ GVM	
	72 sh.

/35.15 OV- /37.2 OV-

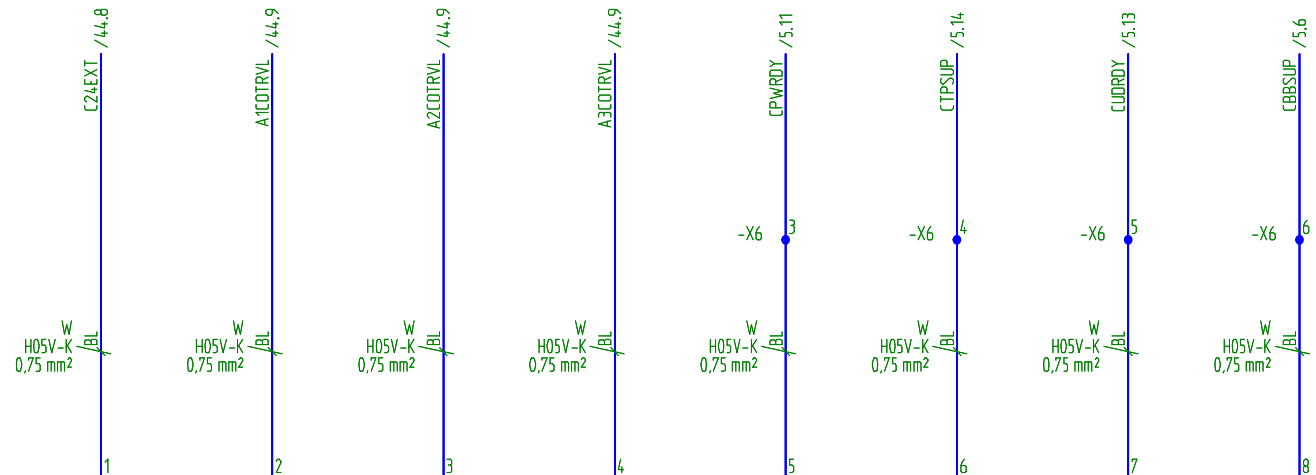

bitadress: .0 .1 .2 .3 .4 .5 .6 .7 9 OVL

InterBus-S Eingangsmodul

refer /37.2 Stecker: X1 RME12.1-32-DC024

-A12.2

(*24 Volt extern*)

(*Sicherheitsenschalter X-Achse*)

(*Sicherheitsenschalter Y-Achse*)

(*Sicherheitsenschalter Z-Achse*)

(*Netzschuetz HVE aktiviert*)

(*Temperaturvorwarnung HVE*)

(*Zwischenkreis Antriebe OK*)

(*Betriebsbereit HVE*)

order no:	29.026	date:	15.09.1999
mach.no.:	990820	drawer:	A. Könnemann
KS-file:	50990820.PRO	modify no.:	
d. carrier:		filing:	01

GVM
 Vakuum Tisch
 Westwind D1296
 Meßtaster

Indramat MTC 200
 drill-bit gauging
 Handbediengerät EBG 2
 synchron Linearantriebe, DIAX04

customer:
 Xynatech
 New Mexico

InterBus-S - Eingangsmodul
 Byte 3
 circuit diagram



E. Wessel GmbH & Co.KG
 electr. produk. equip.
 Tel.: D - 05231/9663-0
 32758 Detmold, Farbenweg 6

= Rack	sheet 36
+ GVM	
	72 st.

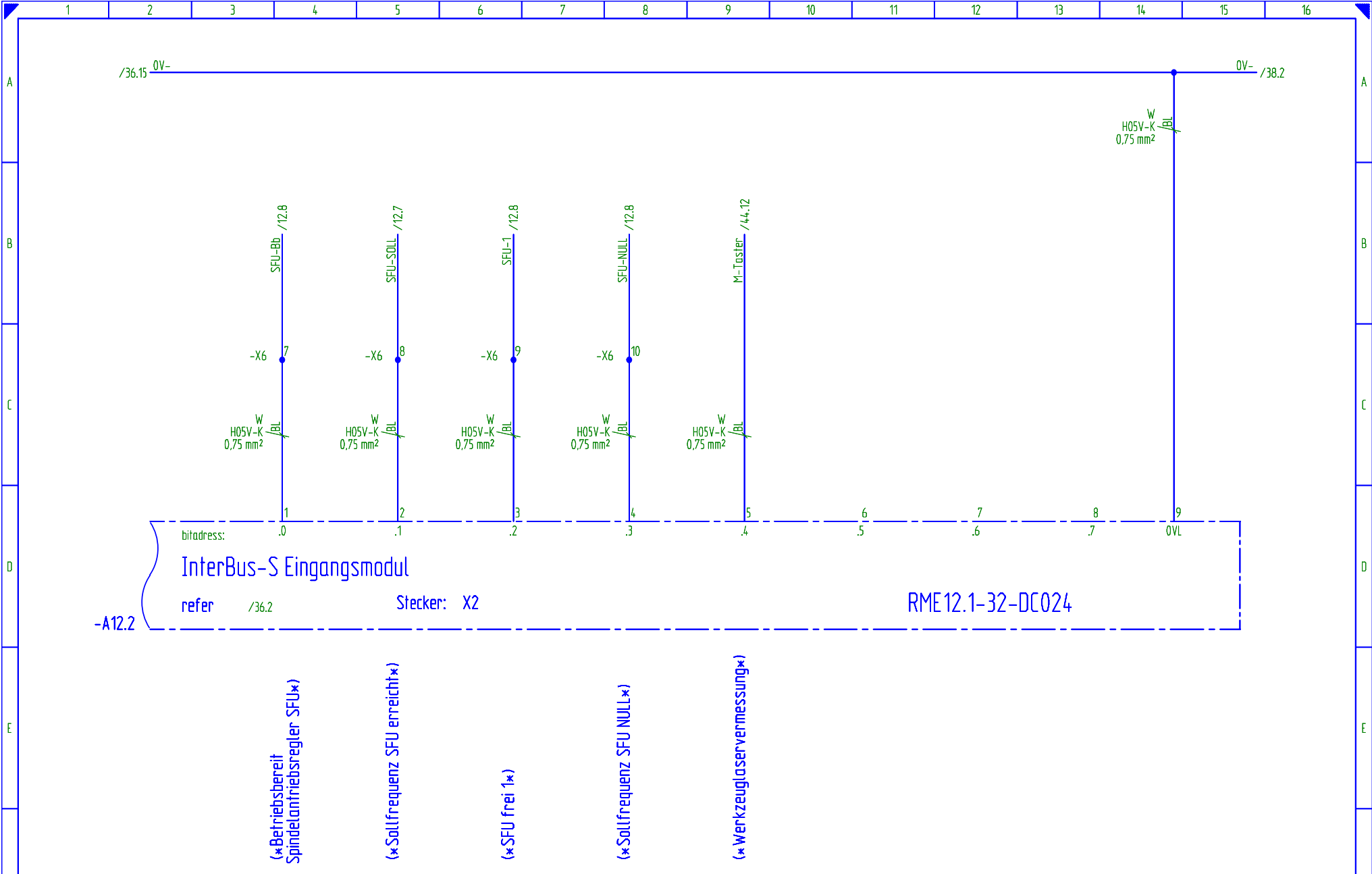

order no.:	29.026	date:	15.09.1999
mach.no.:	990820	drawer:	A. Könnemann
KS-file:	50990820.PRO	modify no.:	
d. carrier:		filing:	01
		modify:	

GVM	Indramat MTC 200	customer:	
Vakuum Tisch	drill-bit gauging	Xynatech	
Westwind D1296	Hanbediengerät EBG 2		
Meßtaster	synchron Linearantriebe, DIAX04	New Mexico	

InterBus-S - Eingangsmodule
Byte 2
 circuit diagram



E. Wessel GmbH & Co.KG
 electr. produk. equip.
 Tel.: D - 05231/9663-0
 32758 Detmold Farbenweg 6

= Rack	sheet 37
+ GVM	
	72 sh.

/37.15 0V- 0V- /39.2

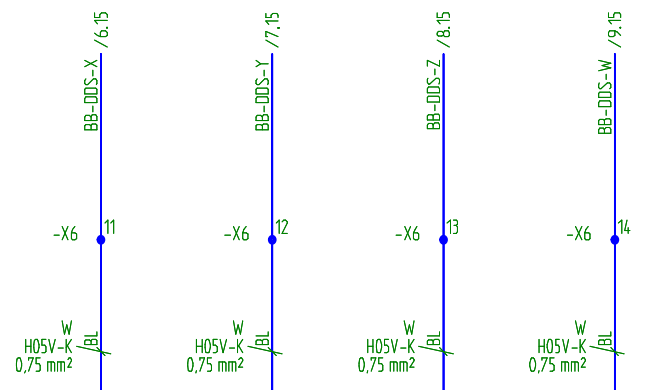

H05V-K
0,75 mm²

bitadress: 0 1 2 3 4 5 6 7 8 9 OVL

InterBus-S Eingangsmodul

refer /39.2 Stecker: X3 RME12.1-32-DC024

-A12.2

(*BB DDS X-Achse*)
 (*BB DDS Y-Achse*)
 (*BB DDS Z-Achse*)
 (*BB DDS W-Achse*)

order no:	29.026	date:	15.09.1999	GVM	Indramat MTC 200	customer:	InterBus-S - Eingangsmodul		E. Wessel GmbH & Co.KG electr. produk. equip. Tel.: D - 05231/9663-0 32758 Detmold Farbenweg 6	= Rack + GVM
mach.no.:	990820	drawer:	A. Könnemann	Vakuum Tisch	drill-bit gauging	Xynatech	Byte 1			
KS-file:	50990820.PRO	modify no.:		Westwind D1296	Hanbediengerät EBG 2					
d. carrier:		filing	01	Meßtaster	synchron Linearantriebe, DIAX04	New Mexico	circuit diagram			72 st.

/38.15 OV-

OV- /40.2

W
H05V-K
0,75 mm²

	1	2	3	4	5	6	7	8	9
bitaddress:	.0	.1	.2	.3	.4	.5	.6	.7	OVL

InterBus-S Eingangsmodul

refer /38.2 Stecker: X4

RME12.1-32-DC024

-A12.2

order no:	29.026	date:	15.09.1999	GVM	Indramat MTC 200	customer:	InterBus-S - Eingangsmodul		E. Wessel GmbH & Co.KG	= Rack
mach.no.:	990820	drawer:	A. Könnemann	Vakuum Tisch	drill-bit gauging	Xynatech	Byte 0		electr. produk. equip.	+ GVM
KS-file:	50990820.PRO	modify no.:		Westwind D1296	Hanbediengerät EBG 2	.		Tel.: D - 05231/9663-0		sheet 39
d. carrier:	. filing	01	modify:	Meßtaster	synchron Linearantriebe, DIAX04	New Mexico	circuit diagram	32758 Detmold Farbenweg 6		72 st.

/35.15 +24V
/39.15 0V-

+24V /4.12
0V- /4.12

W
H05V-K
0,75 mm² /BL

POWON /45.8

POWOFF /45.9

SFU-SISL /12.8

BZ-SFU /45.5

BZ-Masch /45.7

-X6 15

-X6 16

-X6 17

-X6 18

-X6 19

W
H05V-K
0,75 mm² /BL

W
H05V-K
0,75 mm² /BL

W
H05V-K
0,75 mm² /BL

W
H05V-K
0,75 mm² /BL

W
H05V-K
0,75 mm² /BL

bitadress:

.0

.1

.2

.3

.4

.5

.6

.7

+UL OVL

InterBus-S Ausgangsmodul

refer /4.12

Stecker: X1

RMA12.1-32-DC024-200

-A13.2

(*Netzschuetz ein*)

(*Netzschuetz aus*)

(*SFU Start*)

(*Betriebsstundenzähler SFU*)

(*Betriebsstundenzähler Maschine*)

order no:	29.026	date:	15.09.1999
mach.no.:	990820	drawer:	A. Könnemann
KS-file:	50990820.PRO	modify no.:	
d. carrier:	. filing 01	modify:	

GVM	Indramat MTC 200
Vakuum Tisch	drill-bit gauging
Westwind D1296	Hanbediengerät EBG 2
Meßtaster	synchron Linearantriebe, DIAX04

customer:	Xynatech
	New Mexico

InterBus-S - Ausgangsmodul
Byte 3
circuit diagram



E. Wessel GmbH & Co.KG
electr. produk. equip.
Tel.: D - 05231/9663-0
32758 Detmold Farbenweg 6

= Rack
+ GVM
sheet 40
72 sh.

/40.15 +24V
/40.15 0V-

+24V /45.2
0V- =EBG/67.2

W
H05V-K
0.75 mm²

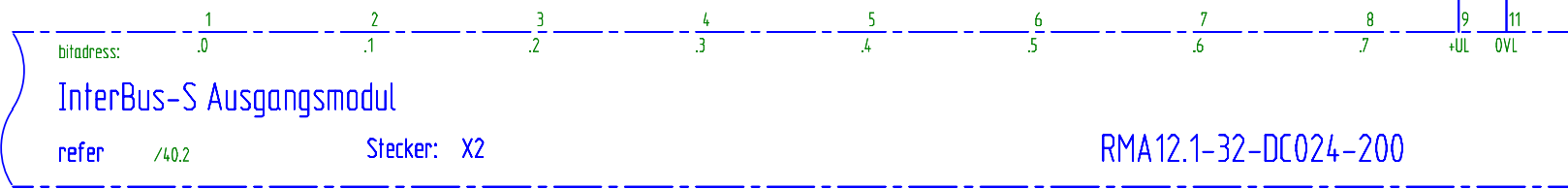

InterBus-S Ausgangsmodul

refer /40.2 Stecker: X2

RMA12.1-32-DC024-200

-A13.2

order no:	29.026	date:	15.09.1999	GVM	Indramat MTC 200	customer:	InterBus-S - Ausgangsmodul		E. Wessel GmbH & Co.KG electr. produk. equip. Tel.: D - 05231/9663-0 32758 Delmold Farbenweg 6	= Rack
mach.no.:	990820	drawer:	A. Koenemann	Vakuum Tisch	drill-bit gauging	Xynatech	Byte 0			+ GVM
KS-file:	50990820.PRO	modify no.:		Westwind D1296	Hanbediengerät EBG 2	.				sheet 41
d. carrier:	. filing 01	modify:		Meßtaster	synchron Linearantriebe, DIAXQ4	New Mexico	circuit diagram			72 sh.

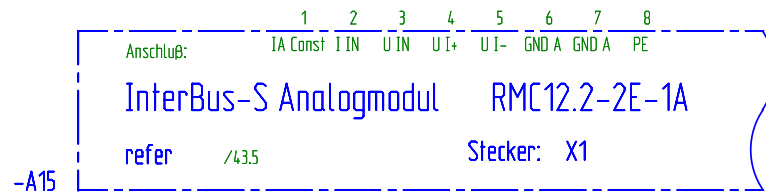
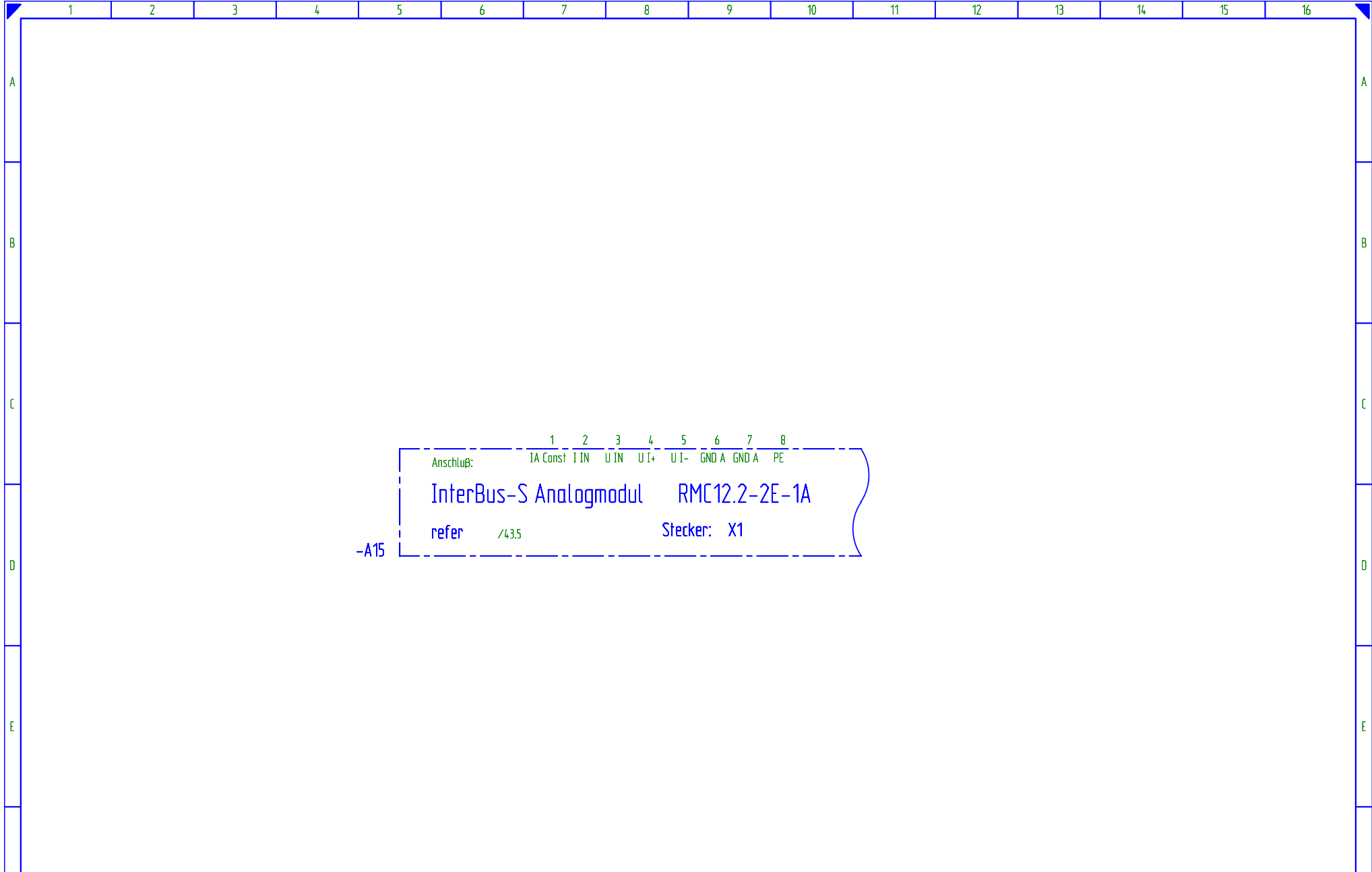

order no:	29.026	date:	15.09.1999
mach.no.:	990820	drawer:	A. Könnemann
KS-file:	50990820.PRO	modify no.:	
d. carrier:	. filing	01	modify:

GVM
 Vakuu Tisch
 Westwind D1296
 Meßtaster

Indramat MTC 200
 drill-bit gauging
 Hanbediengerät EBG 2
 synchron Linearantriebe, DIAXQ4

customer:
 Xynatech
 New Mexico

InterBus-S - Ausgangsmodul Analog
 circuit diagram



E. Wessel GmbH & Co.KG
 electr. produk. equip.
 Tel.: D - 05231/9663-0
 32758 Detmold Farbenweg 6

= Rack	
+ GVM	sheet 42
	72 st.

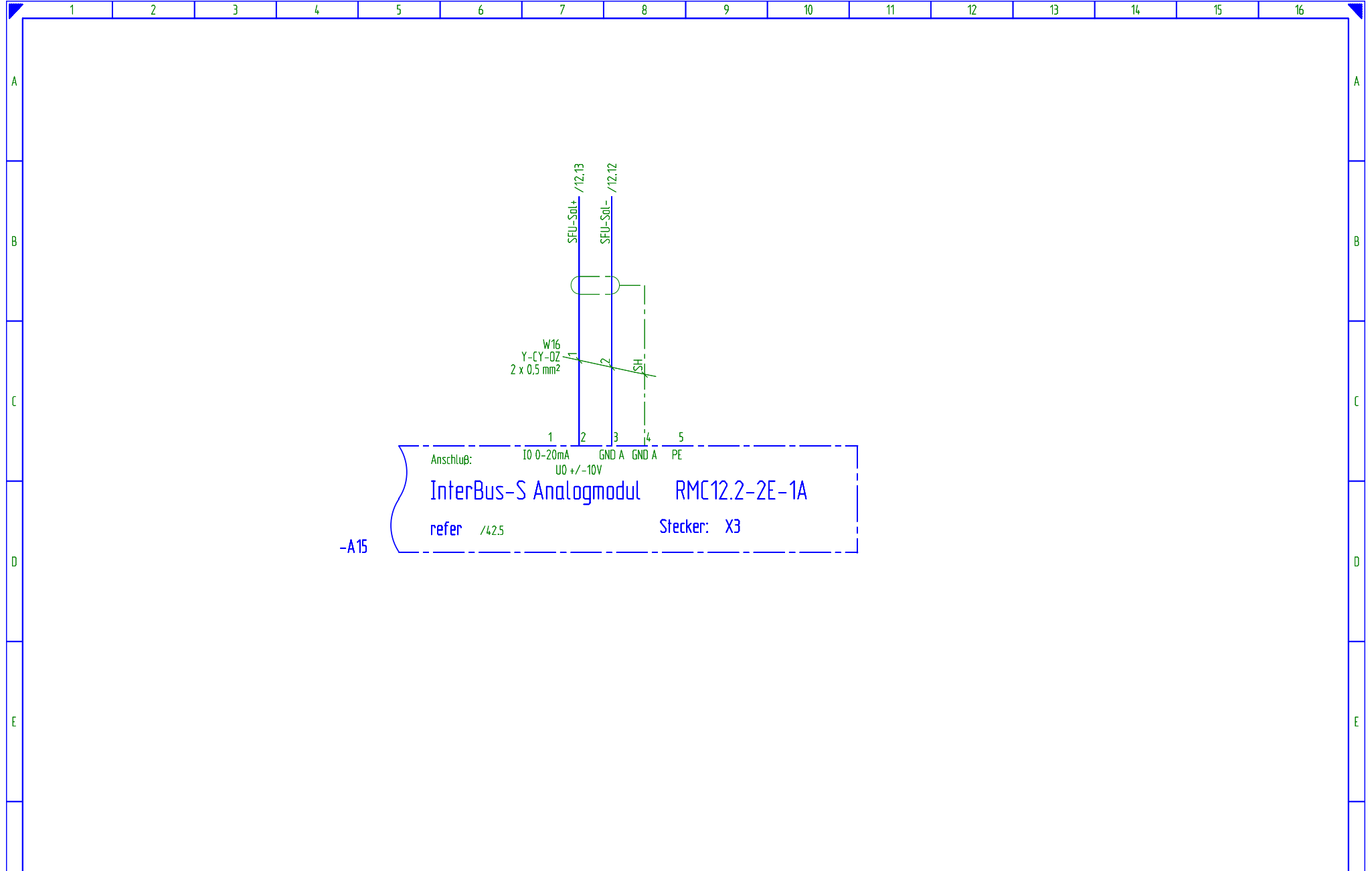

-A15

InterBus-S Analogmodul RMC12.2-2E-1A
 refer /42.5 Stecker: X3

order no:	29.026	date:	15.09.1999
mach.no.:	990820	drawer:	A. Könnemann
KS-file:	50990820.PRO	modify no.:	
d. carrier:	. filing 01	modify:	

GVM
 Vakuum Tisch
 Westwind D1296
 Meßtaster

Indramat MTC 200
 drill-bit gauging
 Handbediengerät EBG 2
 synchron Linearantriebe, DIAXQ4
 New Mexico

customer:
 Xynatech
 .
 New Mexico

InterBus-S - Ausgangsmodul Analog
 circuit diagram



E. Wessel GmbH & Co.KG
 electr. produk. equip.
 Tel.: D - 05231/9663-0
 32758 Detmold Farbenweg 6

= Rack	sheet43
+ GVM	
	72 st.

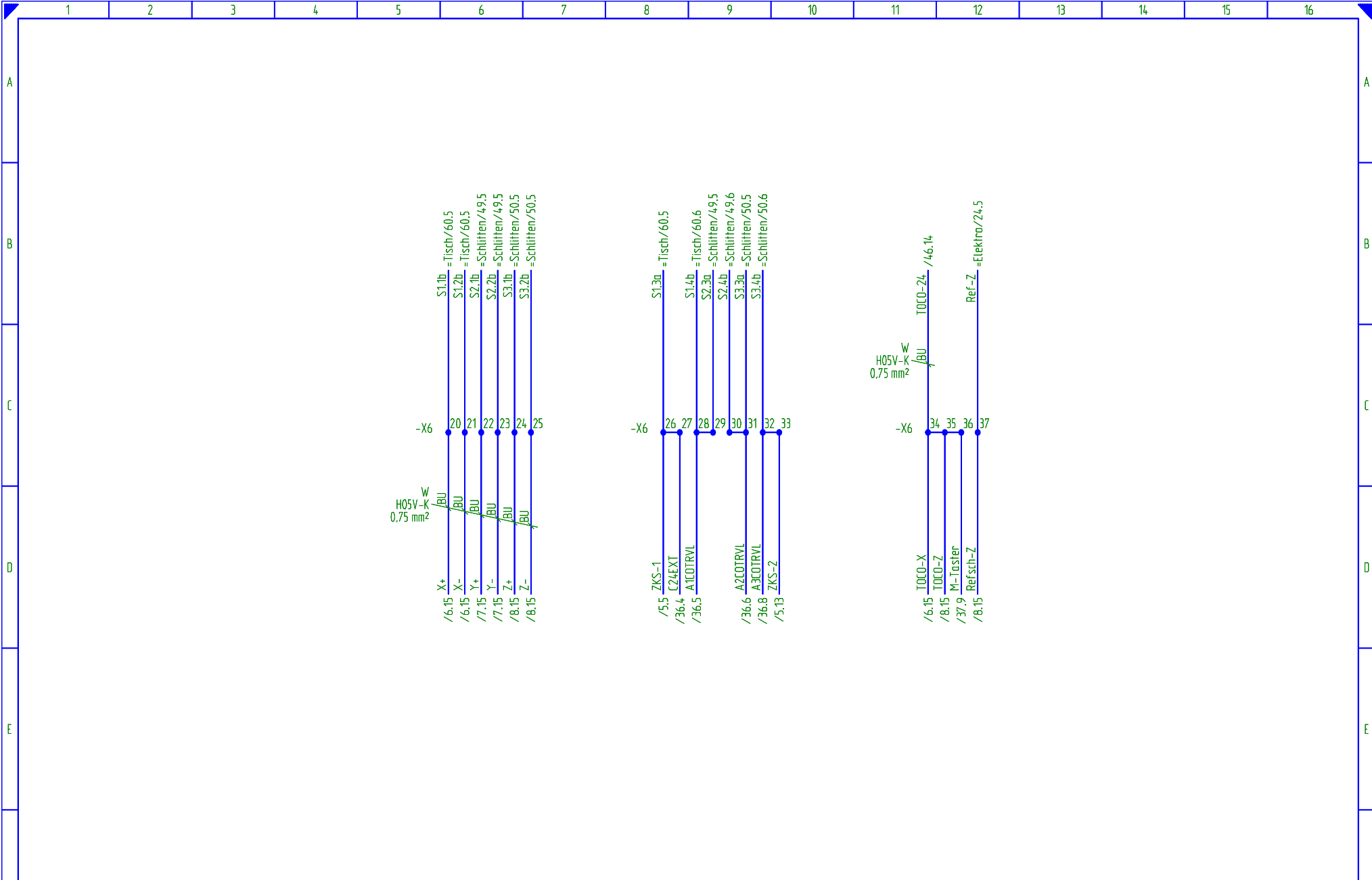

order no.:	29.026	date:	15.09.1999
mach.no.:	990820	drawer:	A. Könnemann
XS-file:	50990820.PRO	modify no.:	01
d. carrier:	.	filing	01
		modify:	AK
		modify:	04.08.98

GVM
 Vakuu Tisch
 Westwind D1296
 Meßtaster

Indramat MTC 200
 drill-bit gauging
 Hanbediengerät EBG 2
 synchron Linearantriebe, DIAXQ4

customer:
 Xynatech
 New Mexico

limit switches
Bereichsendeschalter
 circuit diagram



E. Wessel GmbH & Co.KG
 electr. produk. equip.
 Tel.: D - 05231/9663-0
 32758 Delmold Farbenweg 6

= Rock	sheet 44
+ GVM	
	72 sh.

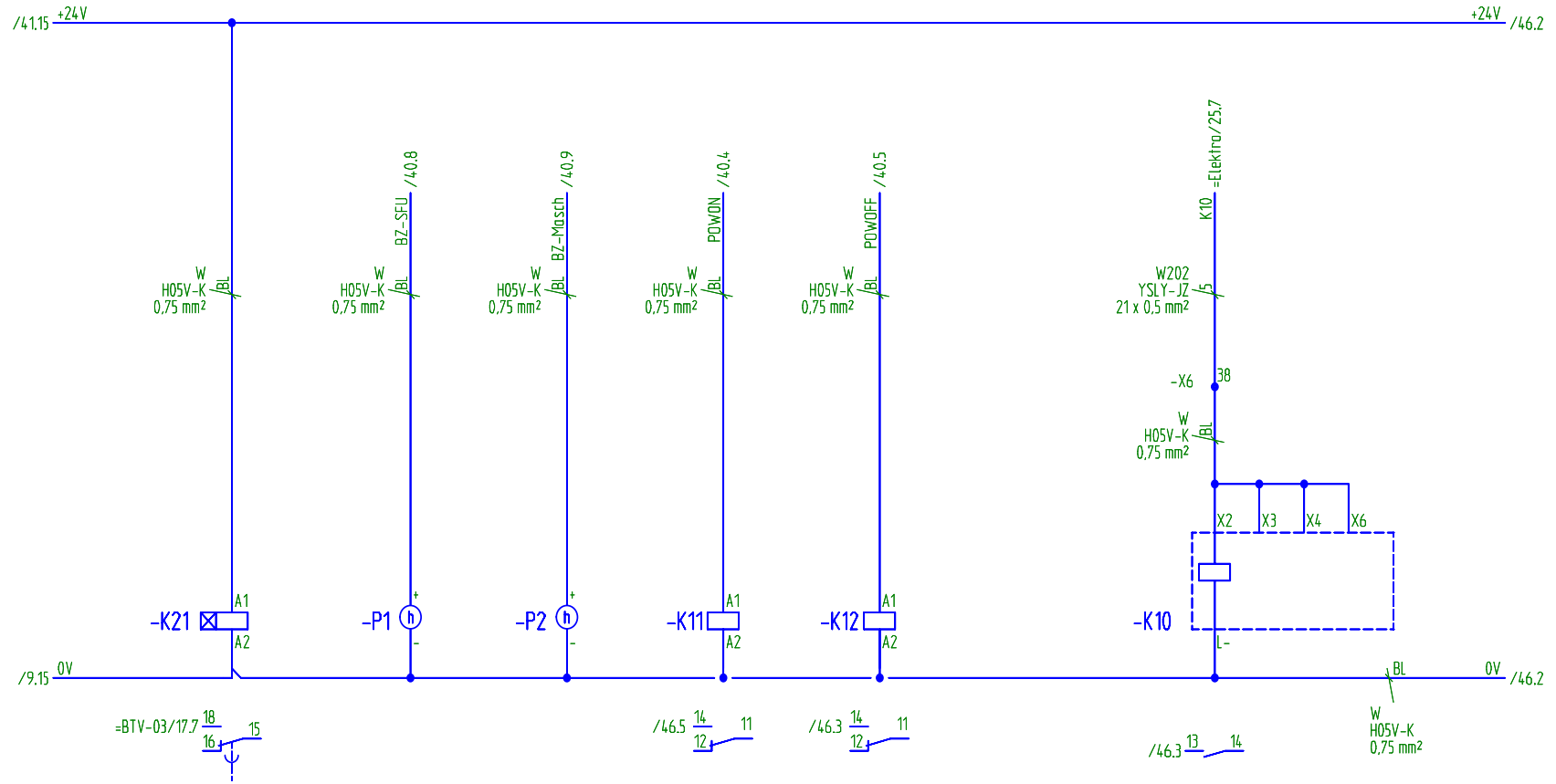

BTV
verzögert Ein

operating time counter
FC Maschine

Leistung
Ein

Leistung
AUS

NOT-AUS
Relais

order no.:	29.026	date:	15.09.1999
mach.no.:	990820	drawer:	A. Könnemann
KS-file:	50990820.PRO	modify no.:	
d. carrier:	. filing	01	modify:

GVM	Indramat MTC 200
Vakuum Tisch	drill-bit gauging
Westwind D1296	Hanbediengerät EBG 2
Meßtaster	synchron Linearantriebe, DIAXQ4

customer:	Xynatech
	New Mexico

Interface-Relais

circuit diagram



E. Wessel GmbH & Co.KG
electr. produk. equip.
Tel.: D - 05231/9663-0
32758 Detmold Farbenweg 6

= Rack	
+ GVM	
	sheet 45
	72 st.

/45.15 +24V
 /45.15 0V
 /45.15 SFU+15V

+24V /47.2
 0V /47.2
 SFU+15V

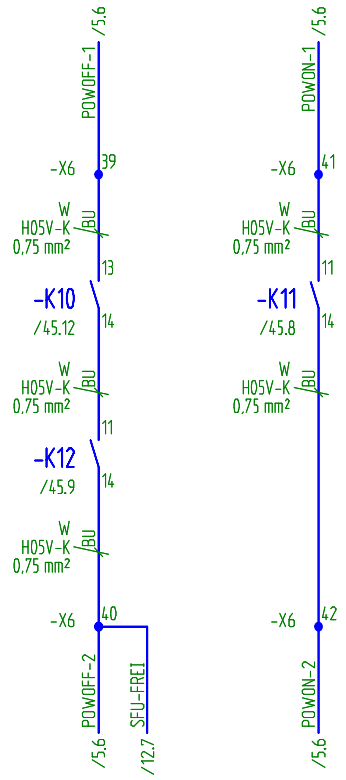

Power On

Power Off

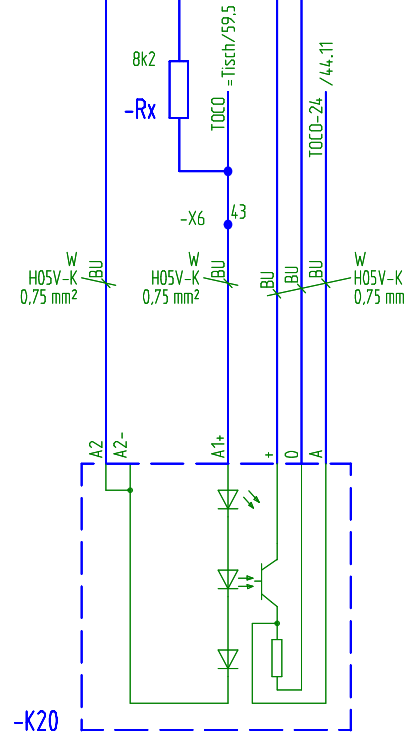

drill-bit gauging
 Signalanpassung

order no.:	29.026	date:	15.09.1999
mach.no.:	990820	drawer:	A. Könnemann
KS-file:	50990820.PRO	modify no.:	
d. carrier:		filing:	01

GVM
 Vakuu Tisch
 Westwind D1296
 Meßtaster

Indramat MTC 200
 drill-bit gauging
 Handbediengerät EBG 2
 synchron Linearantriebe, DIAXQ4

customer:
 Xynatech
 New Mexico

Hilfskontakte
 circuit diagram



E. Wessel GmbH & Co.KG
 electr. produk. equip.
 Tel.: D - 05231/9663-0
 32758 Delmold Farbenweg 6

= Rack	
+ GVM	
	sheet 46
	72 sh.

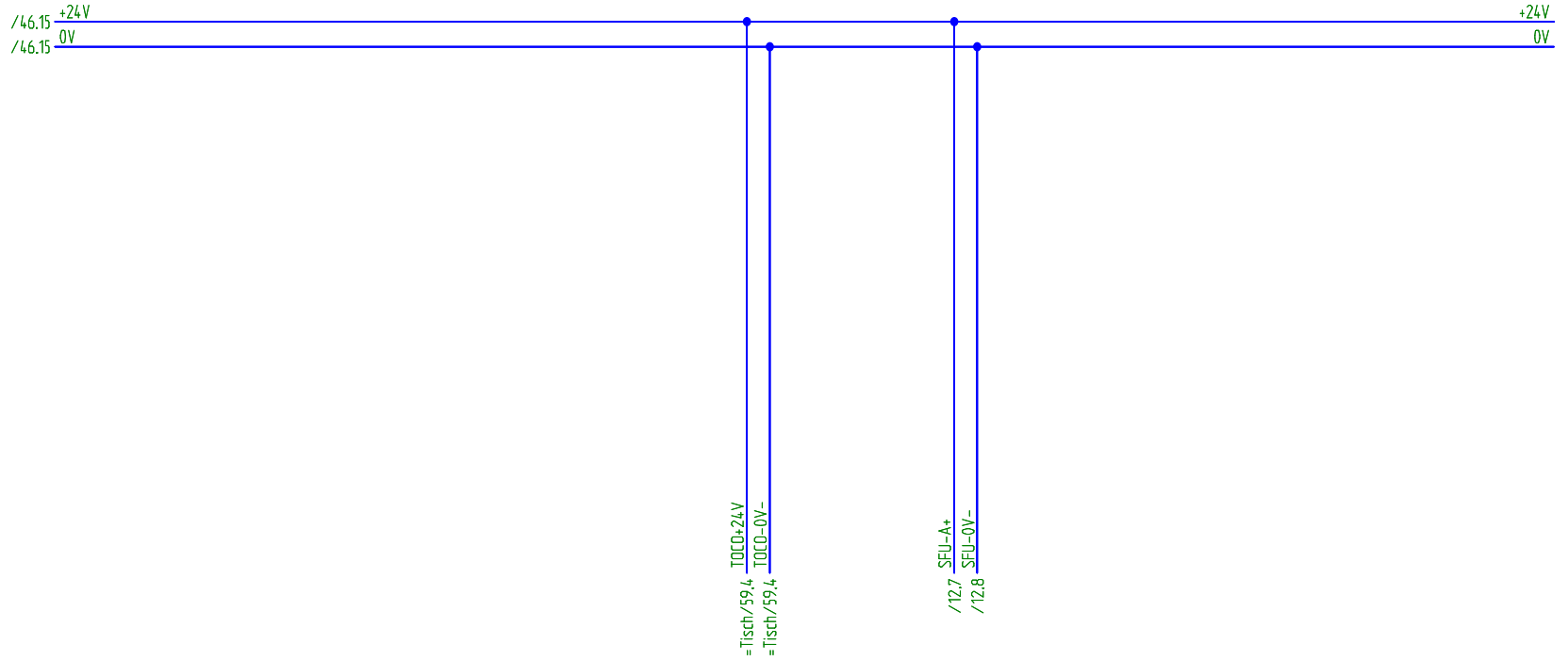

order no.:	29.026	date:	15.09.1999
mach.no.:	990820	drawer:	A. Könnemann
KS-file:	50990820.PRO	modify no.:	
d. carrier:	. filing	01	modify:

GVM
 Vakuu Tisch
 Westwind D1296
 Meßtaster

Indramat MTC 200
 drill-bit gauging
 Hanbediengerät EBG 2
 synchron Linearantriebe, DIAXQ4

customer:
 Xynatech
 New Mexico

voltage supply
 circuit diagram



E. Wessel GmbH & Co.KG
 electr. produk. equip.
 Tel.: D - 05231/9663-0
 32758 Delmold Farbenweg 6

= Rack	sheet 47
+ GVM	
	72 sh.

NOT-AUS 3

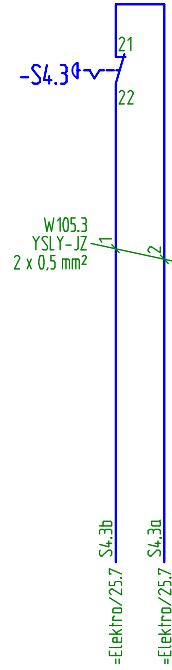

Fronttür
Steuerungsschrank

order no.:	29.026	date:	15.09.1999
mach.no.:	990820	drawer:	A. Könnemann
XS-file:	50990820.PRO	modify no.:	
d. carrier:	. filing 01	modify:	

GVM
Vakuum Tisch
Westwind D1296
Meßtaster

Indramat MTC 200
drill-bit gauging
Hanbediengerät EBG 2
synchron Linearantriebe, DIAXQ4

customer:
Xynatech
New Mexico

emergency-stop
circuit diagram



E. Wessel GmbH & Co.KG
electr. produk. equip.
Tel.: D - 05231/9663-0
32758 Detmold Farbenweg 6

= Rack	sheet 48
+ GVM	
	72 sh.

Bereichsendschalter Y-Achse + Bereichsendschalter Y-Achse - limit switches Y-Achse + limit switches Y-Achse -

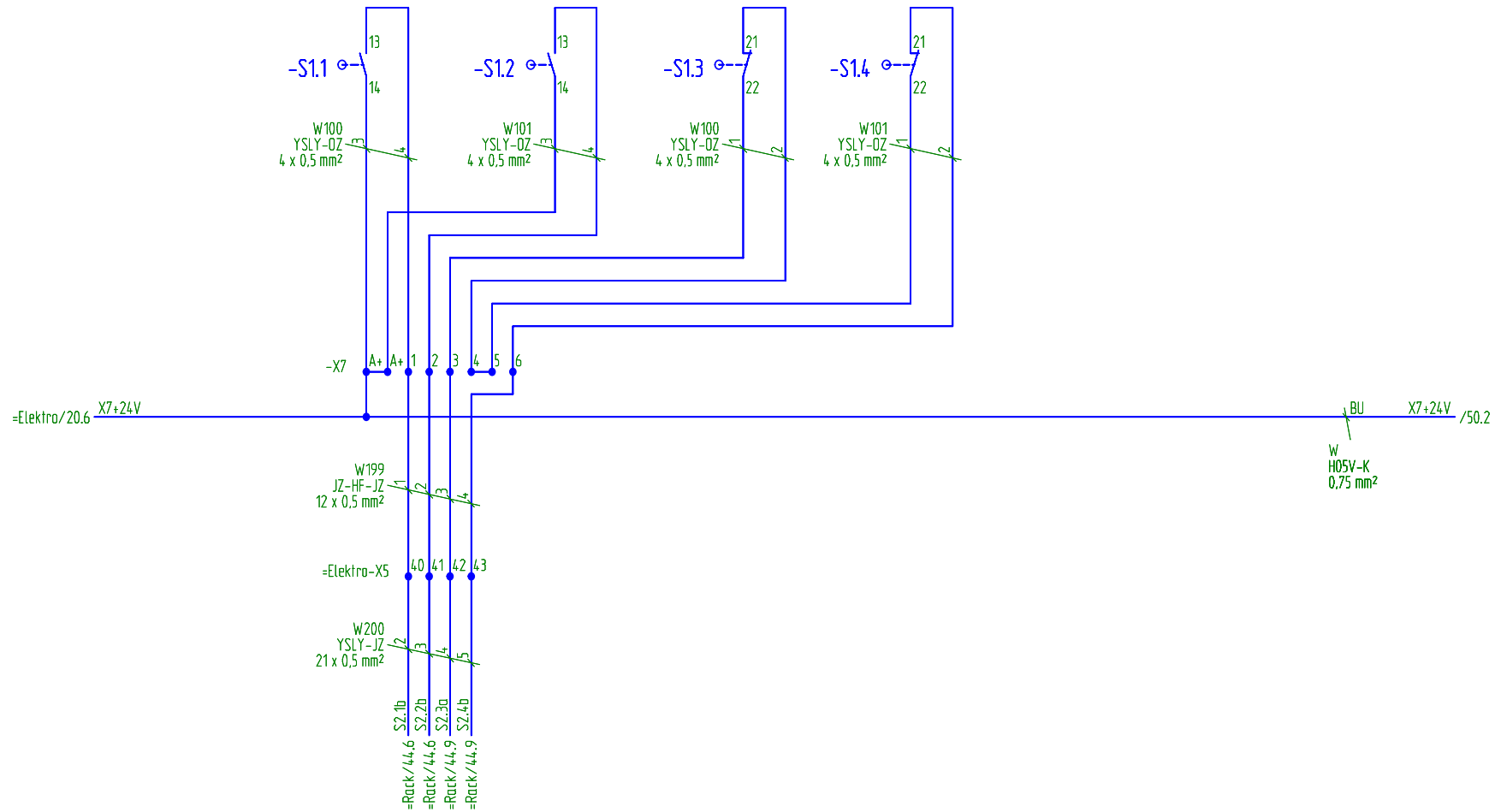

order no.:	29.026	date:	15.09.1999
mach.no.:	990820	drawer:	A. Könnemann
KS-file:	50990820.PRO	modify no.:	01
d. carrier:	.	modify:	04.08.98

GVM
 Vakuu Tisch
 Westwind D1296
 Meßtaster

Indramat MTC 200
 drill-bit gauging
 Handbediengerät EBG 2
 synchron Linearantriebe, DIAX04

customer:
 Xynatech
 New Mexico

limit switches
Bereichsendschalter
 circuit diagram



E. Wessel GmbH & Co.KG
 electr. produk. equip.
 Tel.: D - 05231/9663-0
 32758 Delmold Farbenweg 6

= Schlitten	sheet 49
+ GVM	
	72 sh.

Bereichsendschalter Z-Achse + Bereichsendschalter Z-Achse - limit switches Z-Achse + limit switches Z-Achse -

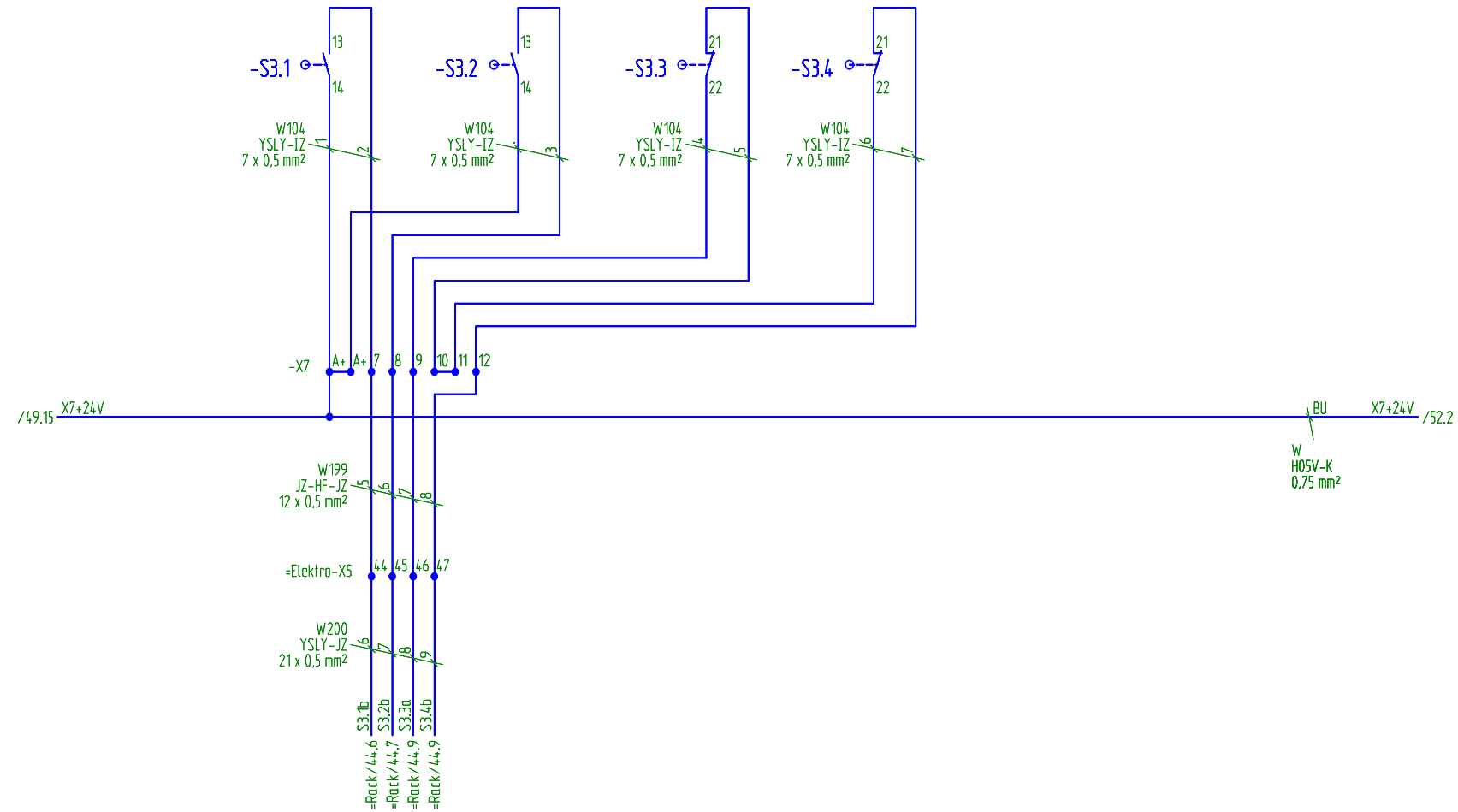

order no.:	29.026	date:	15.09.1999
mach.no.:	990820	drawer:	A. Könnemann
KS-file:	50990820.PRO	modify no.:	
d. carrier:	. filing	01	modify:

GVM
 Vakuum Tisch
 Westwind D1296
 Meßtaster

Indramat MTC 200
 drill-bit gauging
 Handbediengerät EBG 2
 synchron Linearantriebe, DIAX04

customer:
 Xynatech
 New Mexico

limit switches
Bereichsendschalter
 circuit diagram



E. Wessel GmbH & Co.KG
 electr. produk. equip.
 Tel.: D - 05231/9663-0
 32758 Detmold Farbenweg 6

= Schlitten	sheet 50
+ GVM	
	72 sh.

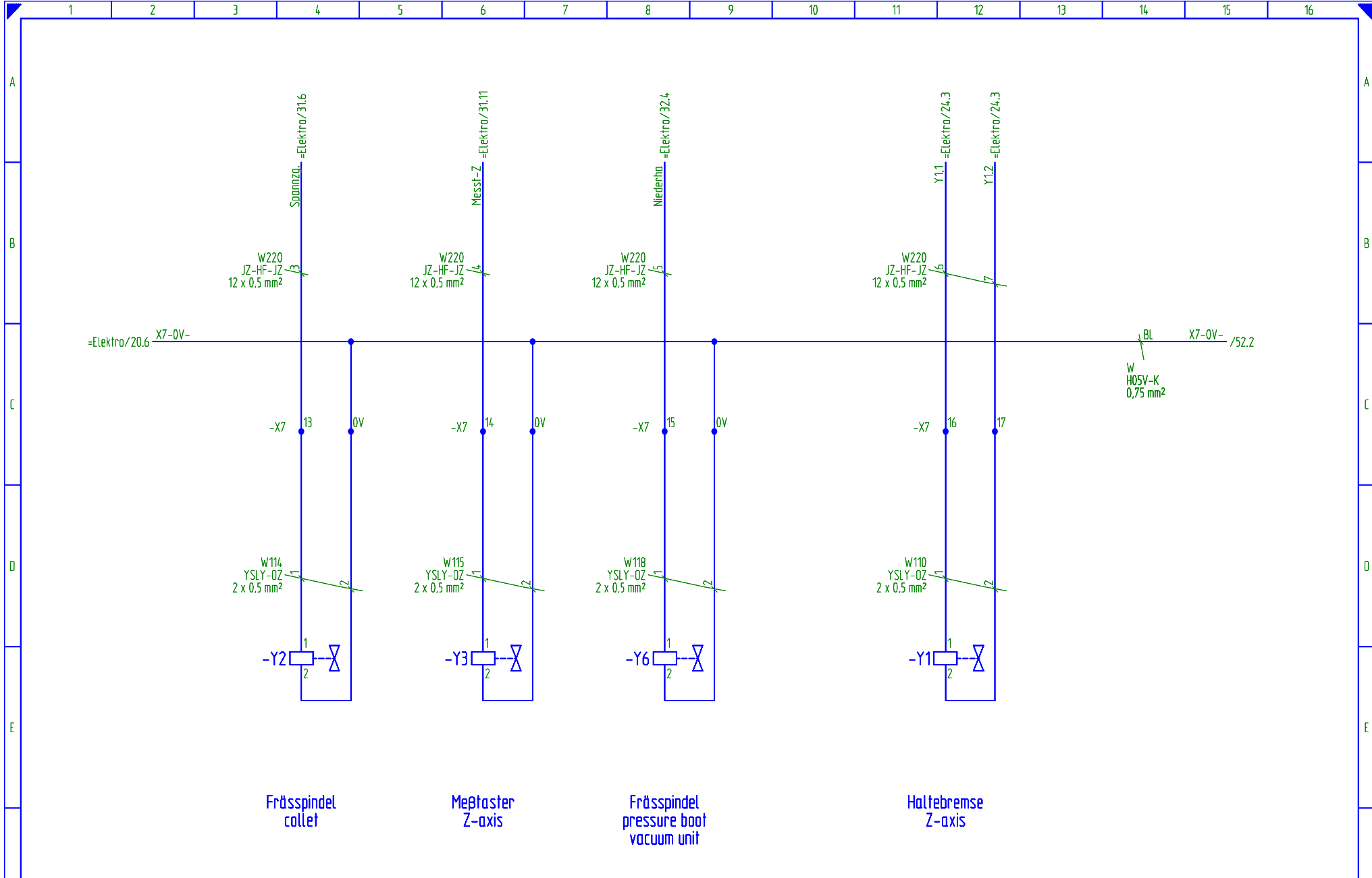

order no.:	29.026	date:	15.09.1999	GVM	Indramat MTC 200	customer:	Magnetventile		 E. Wessel GmbH & Co.KG electr. produk. equip. Tel.: D - 05231/9663-0 32758 Detmold Farbenweg 6	= Schlitten
mach.no.:	990820	drawer:	A. Könnemann	Vakuum Tisch	drill-bit gauging	Xynatech				+ GVM
KS-file:	50990820.PRO	modify no.:		Westwind D1296	Hanbediengerät EBG 2					sheet 51
d. carrier:		filing	01	Meßtaster	synchron Linearantriebe, DIAX04	New Mexico	circuit diagram			72 sh.

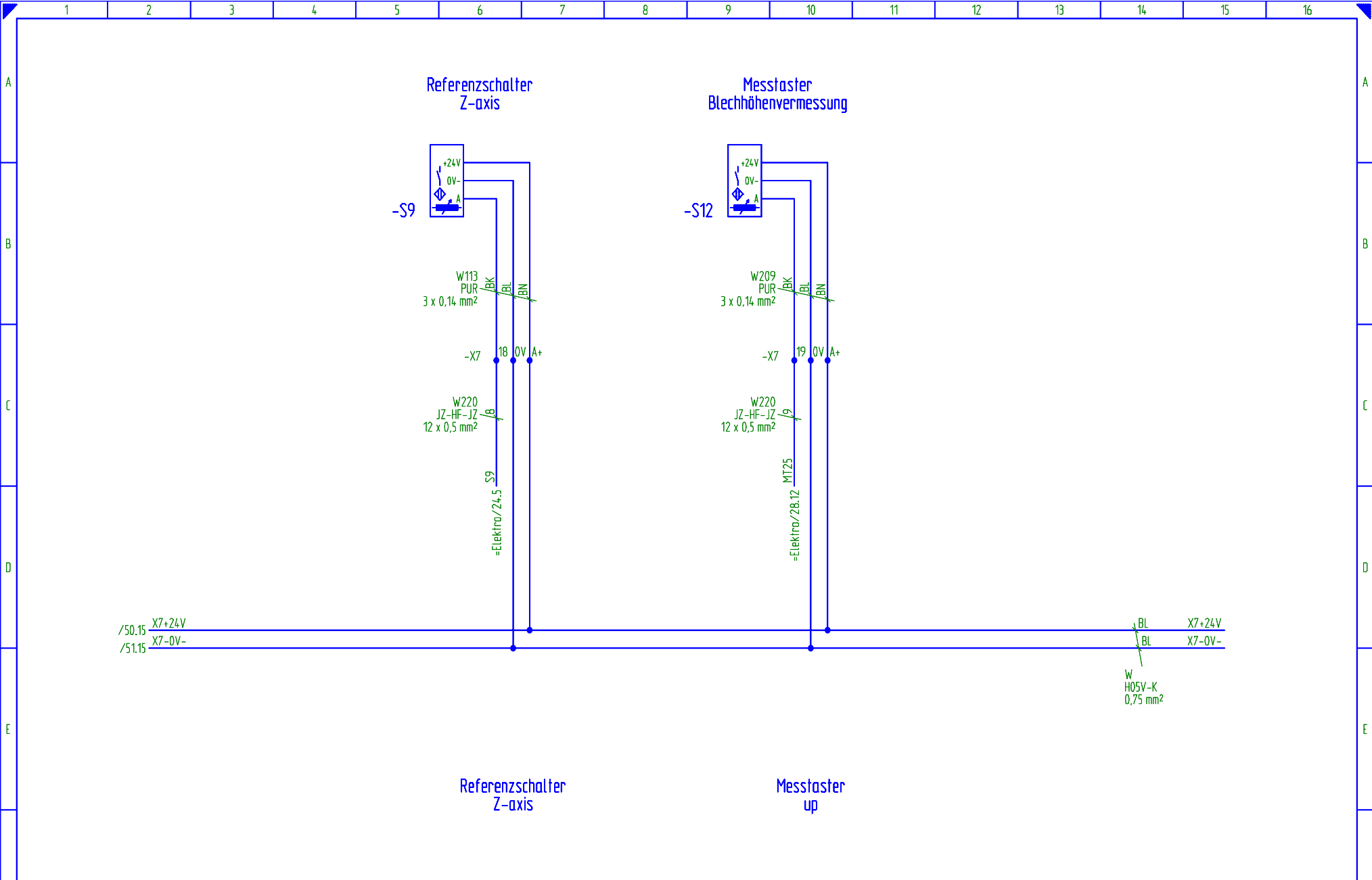

order no.:	29.026	date:	15.09.1999
mach.no.:	990820	drawer:	A. Könnemann
KS-file:	50990820.PRO	modify no.:	
d. carrier:		filing:	01

GVM
 Vakuu Tisch
 Westwind D1296
 Meßtaster

Indramat MTC 200
 drill-bit gauging
 Hanbediengerät EBG 2
 synchron Linearantriebe, DIAX04

customer:
 Xynatech
 New Mexico

**Messtaster
 Referenzschalter**
 circuit diagram



E. Wessel GmbH & Co.KG
 electr. produk. equip.
 Tel.: D - 05231/9663-0
 32758 Detmold Farbenweg 6

= Schlitten	
+ GVM	
	sheet 52
	72 st.

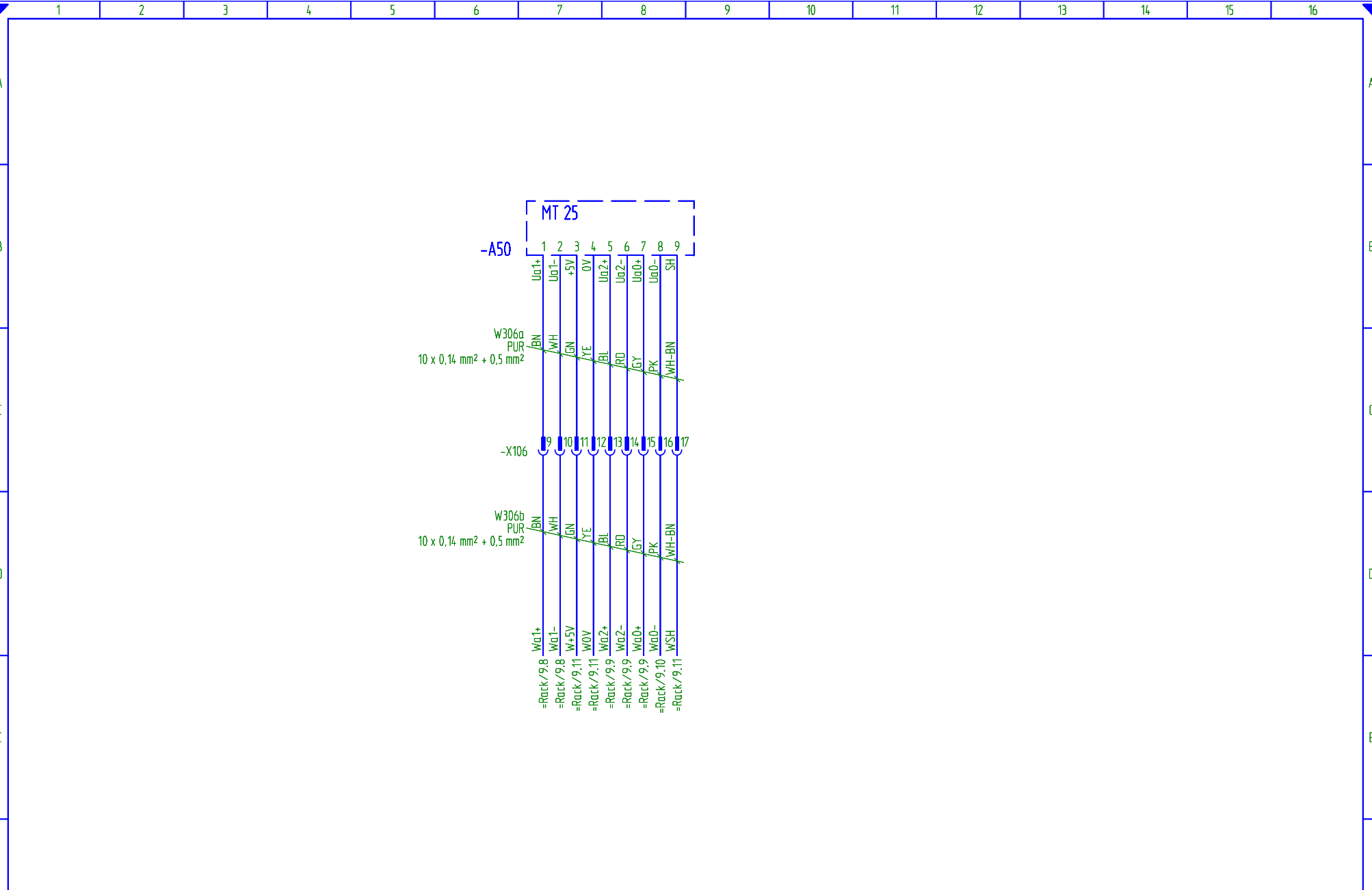

order no.:	29.026	date:	15.09.1999
mach.no.:	990820	drawer:	A. Könnemann
KS-file:	50990820.PRO	modify no.:	
d. carrier:	. filing 01	modify:	

GVM **Indramat MTC 200**
 Vakuu Tisch drill-bit gauging
 Westwind D1296 Handbediengerät EBG 2
 Meßtaster synchron Linearantriebe, DIAX04
 New Mexico

customer:
 Xynatech
 circuit diagram



E. Wessel GmbH & Co.KG
 electr. produk. equip.
 Tel.: D - 05231/9663-0
 32758 Detmold Farbenweg 6

= Schlitten	
+ GVM	sheet 53
	72 sh.

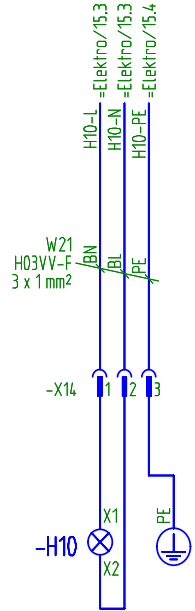

order no.:	29.026	date:	15.09.1999
mach.no.:	990820	drawer:	A. Könnemann
XS-file:	50990820.PRO	modify no.:	
d. carrier:	. filing 01	modify:	

GVM
 Vakuu Tisch
 Westwind D1296
 Meßtaster

Indramat MTC 200
 drill-bit gauging
 Hanbediengerät EBG 2
 synchron Linearantriebe, DIAXQ4

customer:
 Xynatech
 New Mexico

cold light
 circuit diagram



E. Wessel GmbH & Co.KG
 electr. produk. equip.
 Tel.: D - 05231/9663-0
 32758 Detmold Farbenweg 6

= Schlitten	
+ GVM	sheet 54
	72 st.

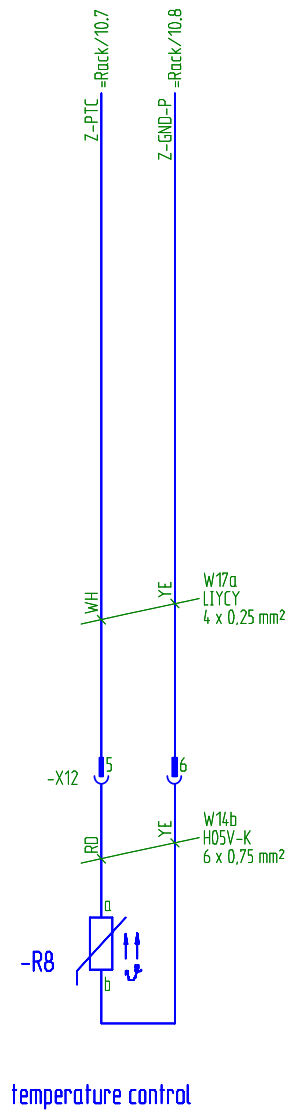
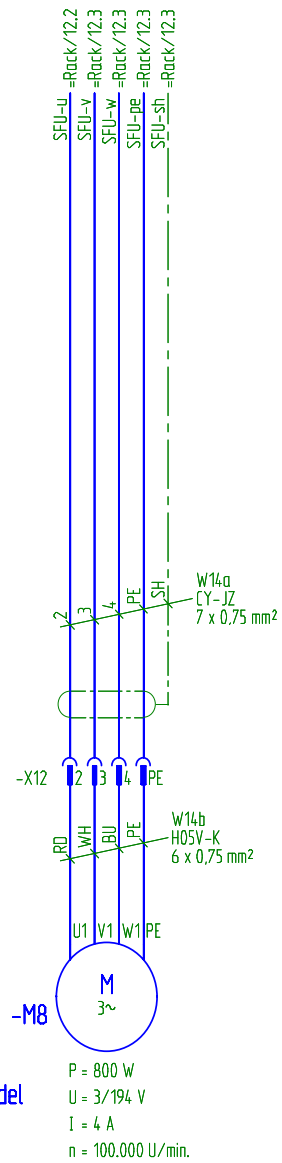

order no.:	29.026	date:	15.09.1999
mach.no.:	990820	drawer:	A. Könnemann
KS-file:	50990820.PRO	modify no.:	
d. carrier:		filing:	01

GVM
 Vakuum Tisch
 Westwind D1296
 Meßtaster

Indramat MTC 200
 drill-bit gauging
 Handbediengerät EBG 2
 synchron Linearantriebe, DIAX04

customer:
 Xynatech
 New Mexico

Frässpindel
Westwind D 1296
 circuit diagram



E. Wessel GmbH & Co.KG
 electr. produk. equip.
 Tel.: D - 05231/9663-0
 32758 Detmold, Farbenweg 6

= Schlitten + GVM	sheet 55
	72 sh.

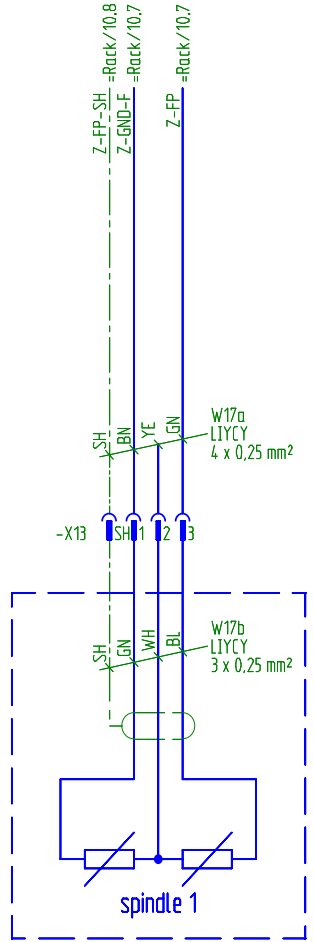

order no.:	29.026	date:	15.09.1999
mach.no.:	990820	drawer:	A. Könnemann
KS-file:	50990820.PRO	modify no.:	
d. carrier:	. filing 01	modify:	

GVM
 Vakuu Tisch
 Westwind D1296
 Meßtaster

Indramat MTC 200
 drill-bit gauging
 Handbediengerät EBG 2
 synchron Linearantriebe, DIAX04

customer:
 Xynatech
 New Mexico

speed sensor
 Westwind D 1296
 circuit diagram



E. Wessel GmbH & Co.KG
 electr. produk. equip.
 Tel.: D - 05231/9663-0
 32758 Detmold Farbenweg 6

= Schlitten	
+ GVM	sheet 56
	72 sh.

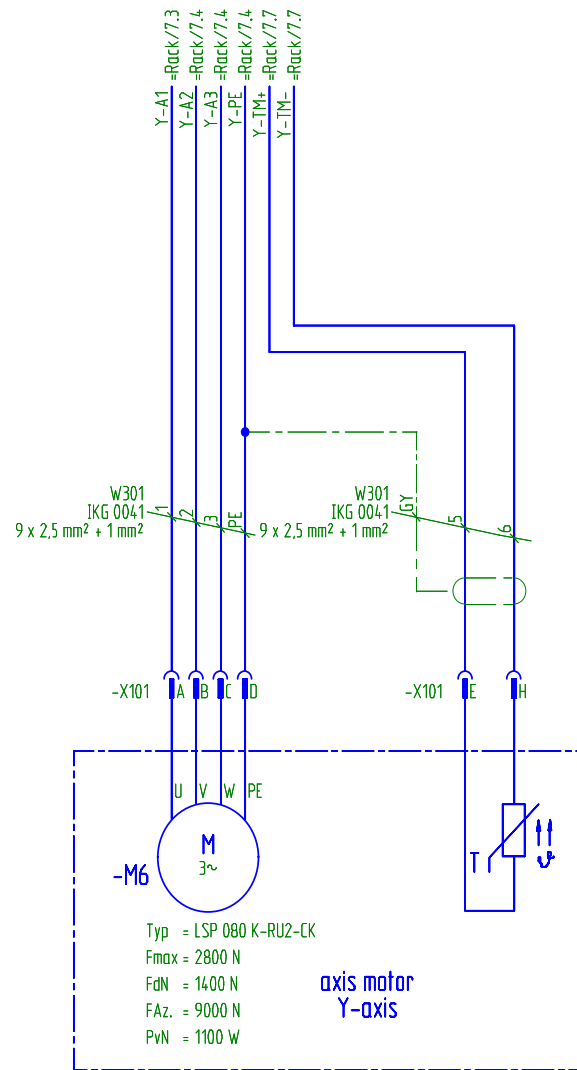

order no:	29.026	date:	15.09.1999
mach.no.:	990820	drawer:	A. Könnemann
KS-file:	50990820.PRO	modify no.:	
d. carrier:	. filing 01	modify:	

GVM	Indramat MTC 200	customer:	
Vakuum Tisch	drill-bit gauging	Xynatech	
Westwind D1296	Hanbediengerät EBG 2	.	
Meßtaster	synchron Linearantriebe, DIAX04	New Mexico	

axis motor
 X-axis
 circuit diagram



E. Wessel GmbH & Co.KG
 electr. produk. equip.
 Tel.: D - 05231/9663-0
 32758 Detmold Farbenweg 6

= Schlitten	sheet 57
+ GVM	
	72 sh.

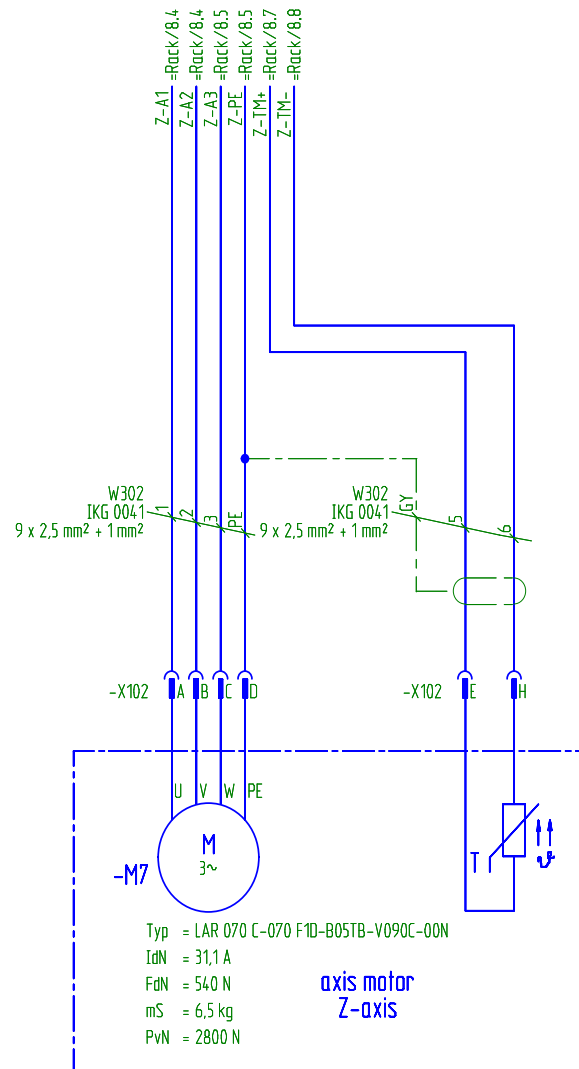

order no.:	29.026	date:	15.09.1999
mach.no.:	990820	drawer:	A. Könnemann
KS-file:	50990820.PRO	modify no.:	
d. carrier:	. filing	01	modify:

GVM
 Vakuu Tisch
 Westwind D1296
 Meßtaster

Indramat MTC 200
 drill-bit gauging
 Handbediengerät EBG 2
 synchron Linearantriebe, DIAX04

customer:
 Xynatech
 New Mexico

**axis motor
Z-axis**
 circuit diagram



E. Wessel GmbH & Co.KG
 electr. produk. equip.
 Tel.: D - 05231/9663-0
 32758 Detmold Farbenweg 6

= Z-AXIS	
+ GVM	sheet 58
	72 sh.

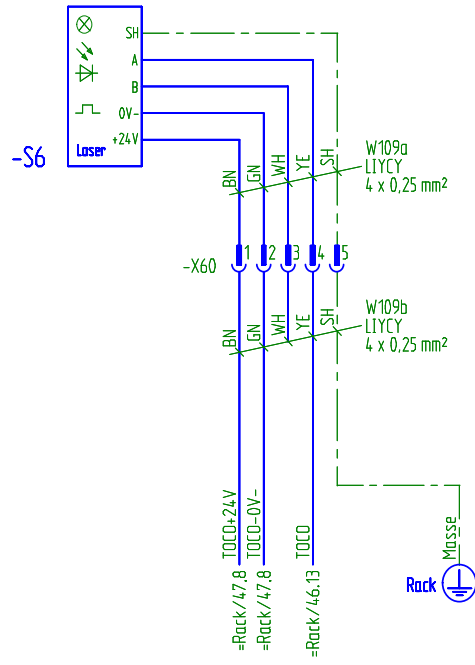

drill-bit gauging

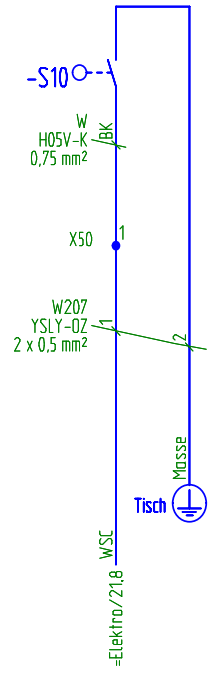

tool change cassette

order no.:	29.026	date:	15.09.1999
mach.no.:	990820	drawer:	A. Könnemann
XS-file:	50990820.PRO	modify no.:	
d. carrier:	. filing	01	modify:

GVM	Indramat MTC 200
Vakuum Tisch	drill-bit gauging
Westwind D1296	Hanbediengerät EBG 2
Meßtaster	synchron Linearantriebe, DIAXQ4

customer:	
Xynatech	
New Mexico	

drill-bit gauging
circuit diagram



E. Wessel GmbH & Co.KG
electr. produk. equip.
Tel.: D - 05231/9663-0
32758 Detmold Farbenweg 6

= Tisch
+ GVM
sheet 59
72 sh.

Bereichsendschalter X-Achse + Bereichsendschalter X-Achse - Limit switches X-Achse + Limit switches X-Achse -

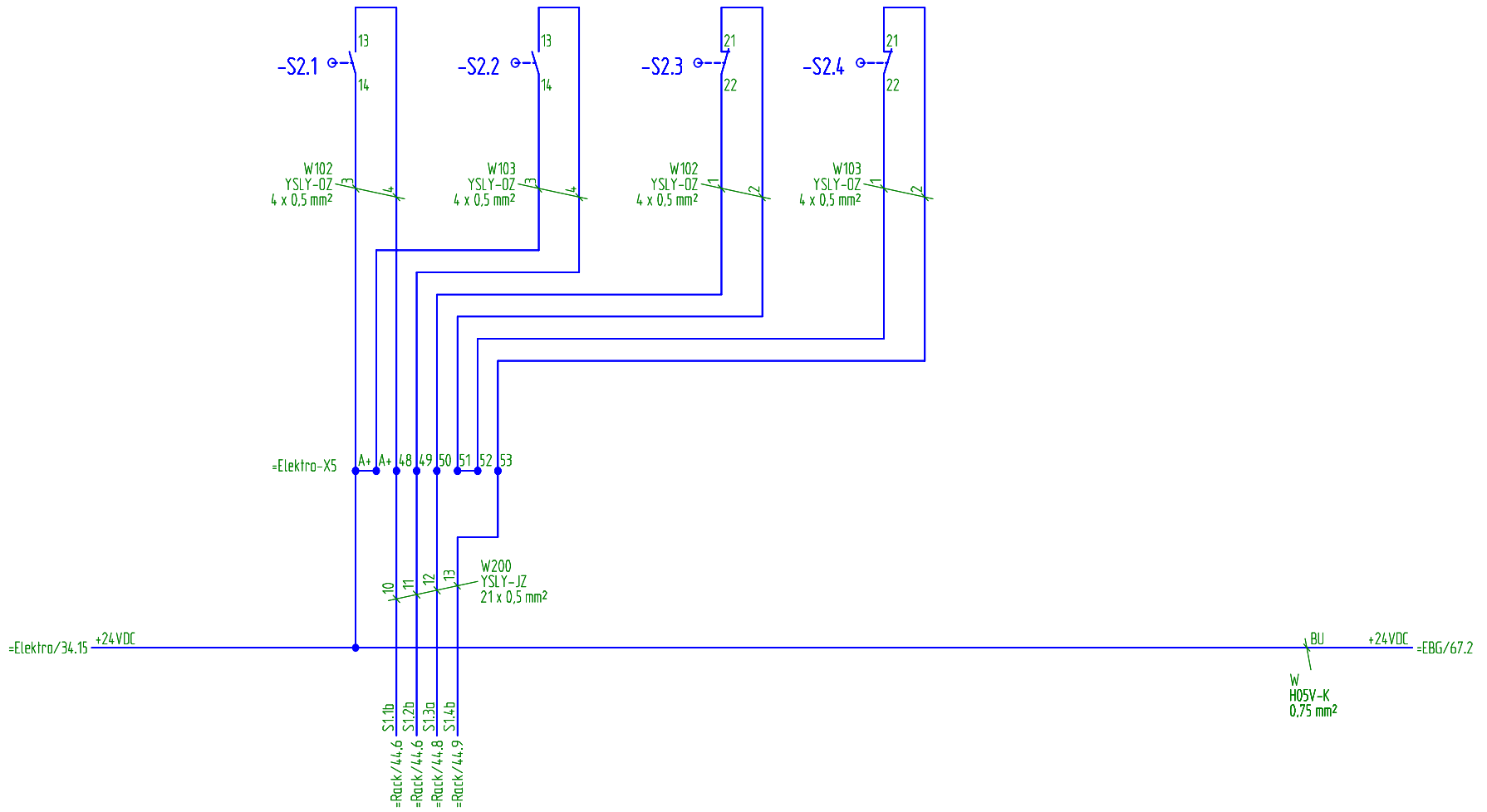

order no.:	29.026	date:	15.09.1999
mach.no.:	990820	drawer:	A. Könnemann
KS-file:	50990820.PRO	modify no.:	01
d. carrier:	.	filing	01
		modify:	04.08.98

GVM
 Vakuum Tisch
 Westwind D1296
 Meßtaster

Indramat MTC 200
 drill-bit gauging
 Handbediengerät EBG 2
 synchron Linearantriebe, DIAXQ4

customer:
 Xynatech
 New Mexico

limit switches
 Bereichsendschalter
 circuit diagram



E. Wessel GmbH & Co.KG
 electr. produk. equip.
 Tel.: D - 05231/9663-0
 32758 Detmold Farbenweg 6

= Tisch	sheet 60
+ GVM	
	72 sh.

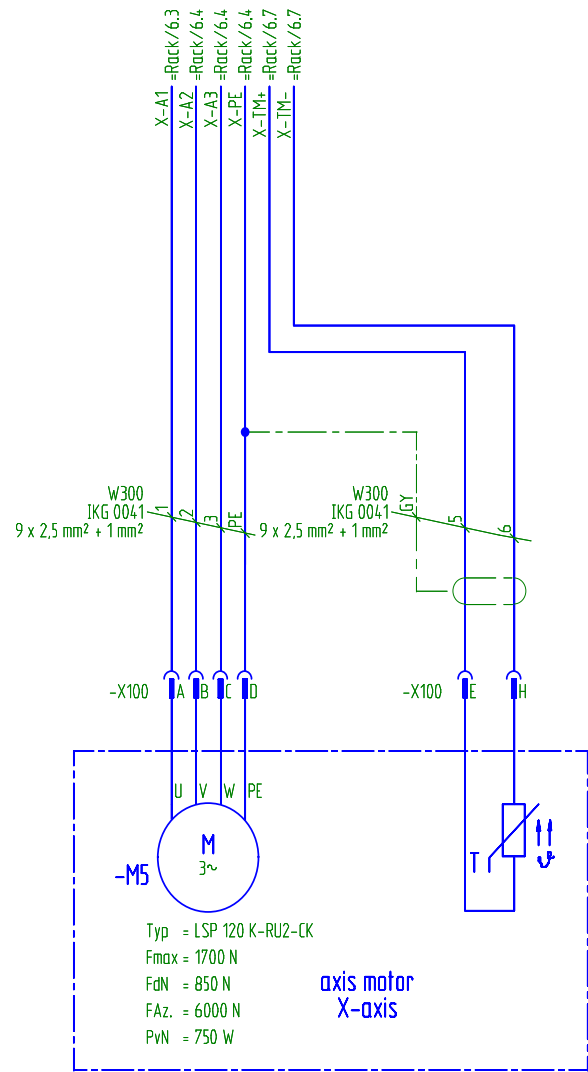

order no.:	29.026	date:	15.09.1999
mach.no.:	990820	drawer:	A. Könnemann
KS-file:	50990820.PRO	modify no.:	
d. carrier:	. filing 01	modify:	

GVM	Indramat MTC 200	customer:	
Vakuum Tisch	drill-bit gauging	Xynatech	
Westwind D1296	Hanbediengerät EBG 2	.	
Meßtaster	synchron Linearantriebe, DIAX04	New Mexico	

axis motor
 X-axis
 circuit diagram



E. Wessel GmbH & Co.KG
 electr. produk. equip.
 Tel.: D - 05231/9663-0
 32758 Detmold Farbenweg 6

= Tisch	sheet61
+ GVM	
	72 sh.

NOT-AUS 1

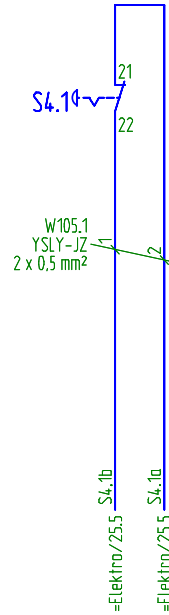

Front links

NOT-AUS 2

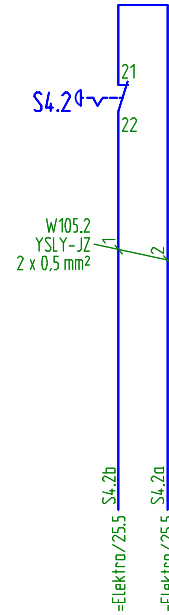

Front rechts

order no.:	29.026	date:	15.09.1999
mach.no.:	990820	drawer:	A. Könnemann
KS-file:	50990820.PRO	modify no.:	
d. carrier:	. filing 01	modify:	

GVM
 Vakuu Tisch
 Westwind D1296
 Meßtaster

Indramat MTC 200
 drill-bit gauging
 Handbediengerät EBG 2
 synchron Linearantriebe, DIAX04

customer:
 Xynatech
 New Mexico

emergency-stop
 circuit diagram



E. Wessel GmbH & Co.KG
 electr. produk. equip.
 Tel.: D - 05231/9663-0
 32758 Detmold Farbenweg 6

= Haube	sheet 62
+ GVM	
	72 sh.

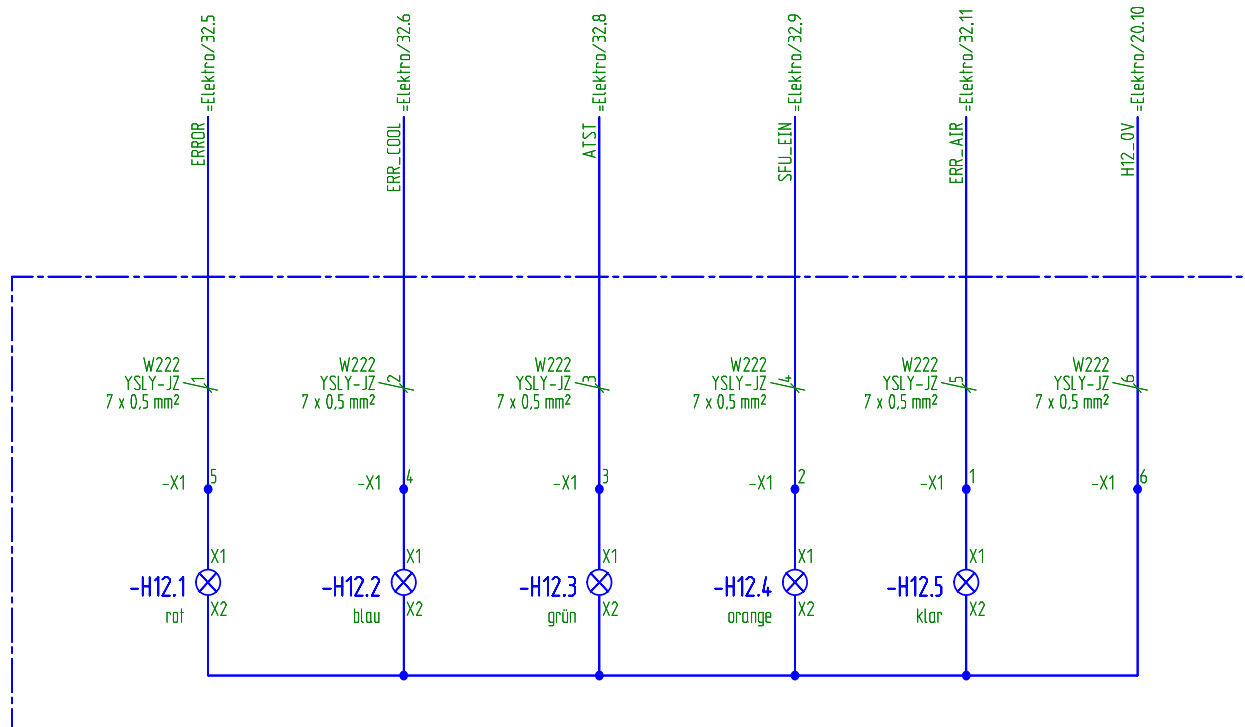

machine error

Fehler
Kühlsystem

working order
Automatik Start

Spindel läuft

Fehler
Luftversorgung

order no.:	29.026	date:	15.09.1999
mach.no.:	990820	drawer:	A. Könnemann
KS-file:	50990820.PRO	modify no.:	
d. carrier:	.	filing	01

GVM
Vakuum Tisch
Westwind D1296
Meßtaster

Indramat MTC 200
drill-bit gauging
Hanbediengerät EBG 2
synchron Linearantriebe, DIAXQ4

customer:
Xynatech
New Mexico

visual indication
working order
circuit diagram



E. Wessel GmbH & Co.KG
electr. produk. equip.
Tel.: D - 05231/9663-0
32758 Detmold Farbenweg 6

= Signal + GVM
sheet 63
72 sh.

compressed air switch
main air

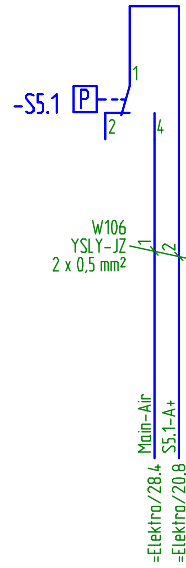

compressed air switch
drill spindle

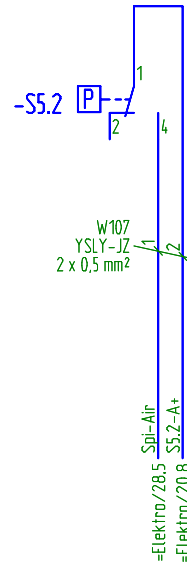

order no.:	29.026	date:	15.09.1999
mach.no.:	990820	drawer:	A. Könnemann
KS-file:	50990820.PRO	modify no.:	
d. carrier:	. filing 01	modify:	

GVM
Vakuum Tisch
Westwind D1296
Meßtaster

Indramat MTC 200
drill-bit gauging
Handbediengerät EBG 2
synchron Linearantriebe, DIAXQ4

customer:
Xynatech
New Mexico

Druckluftwächter
circuit diagram



E. Wessel GmbH & Co.KG
electr. produk. equip.
Tel.: D - 05231/9663-0
32758 Detmold Farbenweg 6

= Pneumatik + GVM	sheet 64
	72 st.

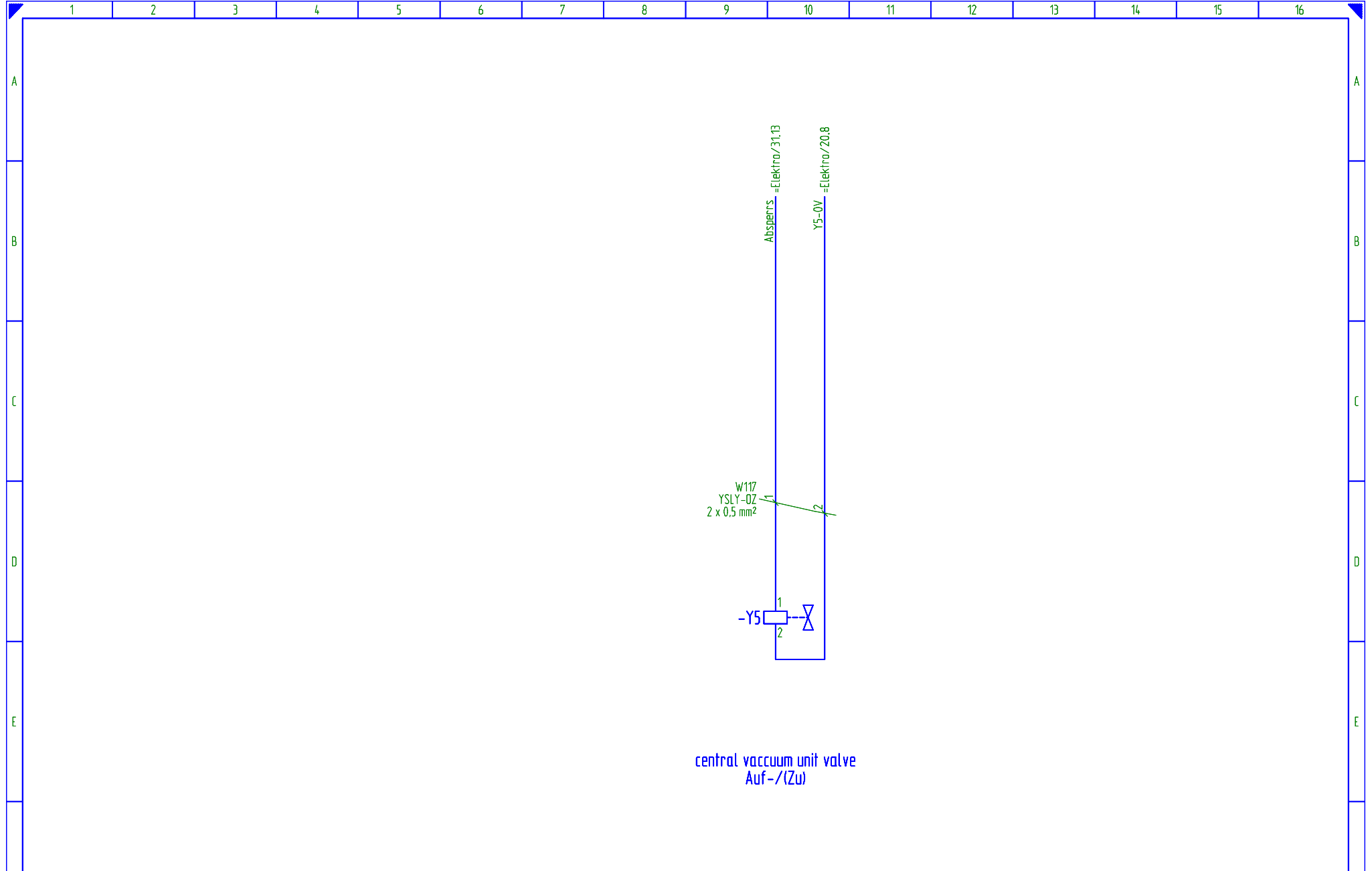

central vacuum unit valve
Auf-/Zu

order no.:	29.026	date:	15.09.1999
mach.no.:	990820	drawer:	A. Könnemann
KS-file:	50990820.PRO	modify no.:	
d. carrier:	. filing	01	modify:

GVM
Vakuum Tisch
Westwind D1296
Meßtaster

Indramat MTC 200
drill-bit gauging
Hanbediengerät EBG 2
synchron Linearantriebe, DIAXQ4

customer:
Xynatech
New Mexico

**Magnetventile
Pneumatik**

circuit diagram



E. Wessel GmbH & Co.KG
electr. produk. equip.
Tel.: D - 05231/9663-0
32758 Detmold Farbenweg 6

= Pneumatik + GVM	sheet 65
	72 st.