

What's in the box

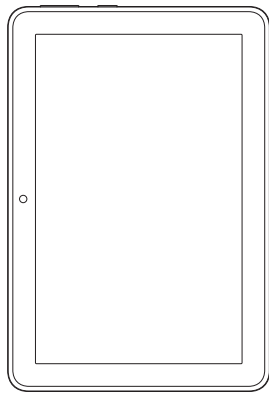

Fire tablet

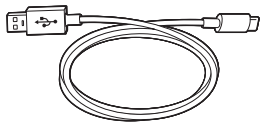



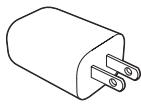





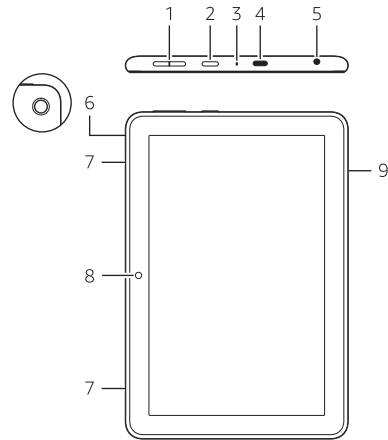

USB-C cable
(for power)



Power adapter

Fire HD 8 overview



- | | |
|---|---|
| 1.  Volume up/down | 6.  Rear camera |
| 2.  Power button | 7.  Speakers |
| 3.  Microphone | 8.  Front camera |
| 4.  USB-C port | 9.  microSD slot
(card sold separately) |
| 5.  Headphone jack | |

Getting started

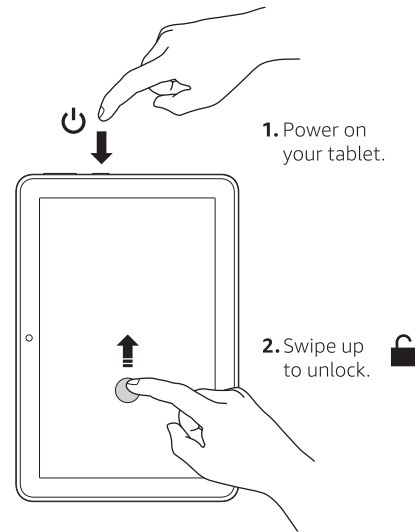

1. Power on your tablet.
2. Swipe up to unlock.
3. Follow the on-screen prompts to connect to a wifi network, then sign into an existing account or register to create a new account.

Charging your tablet

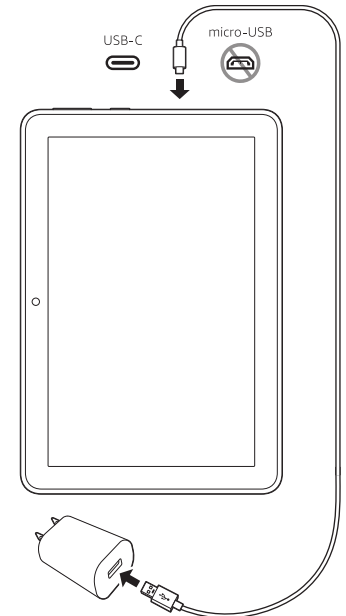

For troubleshooting tips and Amazon Customer Service, visit www.amazon.com/devicesupport.