

MAXXFAN[®]

INSTALLATION INSTRUCTIONS, INFORMATION AND OPERATING GUIDE

FOR MAXXFAN[®] and MAXXFAN[®] Plus MODELS

4000K • 4001K • 4050K • 4301K • 4401K • 4500K • 4501K • 4801K

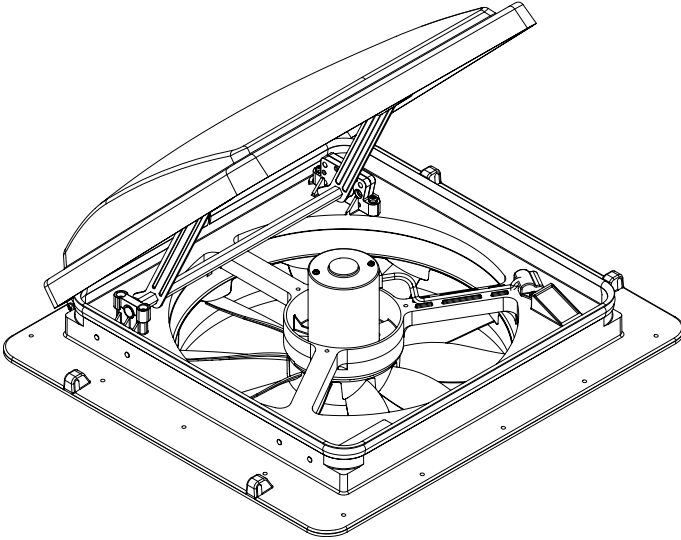

READ AND SAVE THESE INSTRUCTIONS

NOTE: Refer to Installation Instructions, Information and Operation Guides regarding the model you have purchased.

The **MAXXFAN** installs into a standard RV roof opening of 14 by 14 inches.

To determine if your roof opening is correctly sized, simply remove the interior ceiling garnish trim ring of your existing roof vent and measure the ceiling opening or verify the opening is large enough by sliding the **MAXXFAN** interior Garnish trim ring into the opening.

The **MAXXFAN** is designed for a minimum roof thickness of 2 inches to a maximum of 6 1/2 inches. If your roof thickness is less than 2 inches, build additional thickness at the ceiling opening using wood or other suitable material.

The **MAXXFAN** requires a minimum 12 Volt DC, 5 amp service. Confirm that the circuit you intend to use will accommodate the additional load. Use the proper gauge stranded wire for electrical connections.

WARNING! To reduce risk of fire, injury to persons or damage to property, use only in the manner intended by AIRXCEL, INC. Should you have questions, please contact AIRXCEL/MAXXAIR VENTILATION SOLUTIONS Customer Service at 316.832.4357.

MAXxAIR
VENTILATION SOLUTIONS

INSTALLATION INSTRUCTIONS - ALL MODELS

STEP 1

MAXXFAN requires a 14" x 14" roof opening, if you are replacing another type already installed, remove the old existing roof vent. Remove all old roof sealant for a minimum of 2" entirely around the roof opening.

Place the **MAXXFAN** into the roof opening and trace a pencil line around it to verify the clean seal area that will be required. Note that the **MAXXFAN** must be centered in the roof opening with the hinge of the lid facing the front of the vehicle.

CAUTION: When installing your **MAXXFAN**, only use a caulking/sealant compatible with the flange (plastic product) and the roof surface. DO NOT use materials containing solvents such as or similar to Xylene, Toluene, Methyl Ethyl Ketone, Acetate or Acetone as they can damage the flange. Also, Polysulfide (Thiokol) type sealants must be avoided.

If in doubt, please contact the manufacturer of your RV for further information.

STEP 2

Prior to installing the **MAXXFAN** into the roof opening, apply a continuous strip of BUTYL tape or equivalent to the underside of the flange, making sure to cover the screw holes.

CAUTION: Disconnect main vehicle power before connecting 12 volt DC power to the **MAXXFAN**!



STEP 3

Using the insulated 16 gauge electrical connectors provided, connect the vehicle's 12 volt power to the two **MAXXFAN** power wires located on the driver side of the **MAXXFAN**.

*NOTE: The **MAXXFAN** black wire identified with a tag showing (+) must be connected to the vehicle 12 volt (+) positive supply.*

STEP 4

Insert the **MAXXFAN** into the opening with the lid hinge facing the front of the vehicle and centering the **MAXXFAN** in the opening. Make sure the power wires slide to the interior and do not become entangled. Using the sixteen (16) screws provided, screw the flange to the roof at each raised ring dimple location along the flange. Screw into the dimple to pierce the flange, making sure not to overtighten the screws to avoid cracking the flange.



STEP 5

After the **MAXXFAN** has been installed, remove the excess BUTYL caulk that may have squeezed out. Using a sealer such as Dicor self-leveling lap sealant or similar caulking, apply a daub over every exposed screw head. In addition, apply a bead (approximately 3/16") along the outside edge of the flange all the way around the vent.



THIS COMPLETES THE ROOF TOP PORTION OF THE INSTALLATION

NOTE: Re-apply 12 volt vehicle power. The **MAXXFAN**, excluding the 4301K and 4401K models, will emit a beeping sound to indicate power is properly connected. In addition, the Remote Control model will automatically close the vent cover. If the **MAXXFAN** does not beep when power is connected, go back to step #3. Confirm that proper connections were made and 12 volt power is on and available. This **MAXXFAN** incorporates a self-resetting fuse on the circuit board located in the ceiling assembly. It can be reset by removing and re-applying power. If your fan fails to operate or needs reset, contact Customer Service at 316.832.4357 for assistance or solicit the aid of an electrical technician.

FOR REMOTE CONTROL MODELS: Please refer to the REMOTE CONTROL OPERATING GUIDE in this manual for use and testing of your remote control. Install two AAA batteries, follow instructions, aim remote at the ceiling unit and test your fan. The Remote Control comes with a cradle for wall mount storage of the Handheld Remote Control. Mount the cradle to your wall using the screws provided.

STEP 6

The interior Garnish Trim Ring must be trimmed to fit your particular RV roof thickness. To accomplish this, measure the distance from the vehicle ceiling surface to each corner of the **MAXXFAN** Control Plate.

Most RV roofs have some slope, so measuring each corner is necessary. The Garnish ring should be cut $1/4"$ to $1/2"$ longer than the dimensions measured at each corner.

In Picture #6 to the right, the installation measures 3 and $1/2"$ from the ceiling (this is an example only) to the Control Plate. After adding $1/2"$ as in this example, using a ruler, place a mark at 4" on each corner of each side of the Garnish Ring (refer to 6A below). Once marked, draw a line connecting all 4" markers on the outside of the Garnish ring and trim accordingly (refer to 6B to the right).

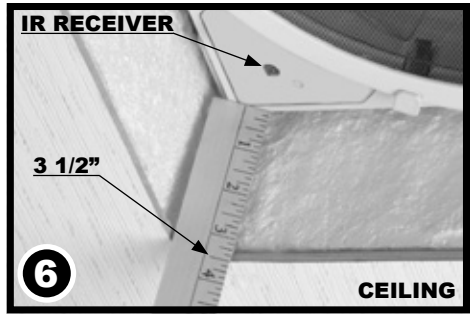

NOTE: DO NOT probe or tamper with the thermostat sensor or IR sensor shown in illustration #6 above.



**MEASUREMENTS STATED
IN STEP 6 ARE USED AS AN
EXAMPLE FOR ILLUSTRATION
PURPOSES ONLY**



STEP 7

Complete the installation by placing any excess wiring to the inside of the roof opening and sliding the Garnish Ring into position. Fasten in place by using the four painted flat head screws provided.

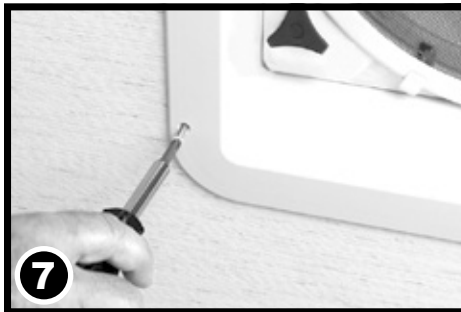

CONGRATULATIONS!!!

You have successfully completed the installation of your new **MAXXFAN**.

If you have questions, please visit Airxcel.com or call us at 316-832-4357.



FOR REMOTE CONTROL MODELS:

Attach the included cradle to wall with (2) #6 screws provided. Handheld Remote Control may be placed into wall cradle for storage.

MAXXFAN® 2 YEAR LIMITED WARRANTY

AIRXCEL, INC. - RV PRODUCTS DIVISION / MAXXAIR Ventilation Solutions warrants to be free of manufacturing defects, regardless of ownership for a period of two (2) years from the original date of purchase. **You must keep your original sales receipt.** This **Limited Warranty** does not include "Acts of God," failure due to misuse, improper installation or accidental / incidental damages. Please call AIRXCEL, INC. at 1-316-832-4357 if you have any questions or need assistance.

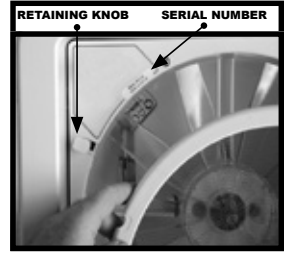

Please have your original sales receipt and MAXXFAN Serial Number readily available. AIRXCEL will correct the confirmed defect within 45 days by repair or replacement without charge for materials and labor. This limited warranty does not cover any freight costs for the return of the product to or from AIRXCEL, INC. or costs associated with installation, removal or reinstallation of the product.

We invite your comments and suggestions regarding our products. Any information you supply is for AIRXCEL / MAXXAIR's internal use and will not be shared or sold to others.

The Serial Number for your MAXXFAN is located on the fan control plate under the round insect screen frame. (Your serial number may or may not be located in the same position as referenced in the above image). Reference your operating guide. Rotate the four retaining knobs 180° and remove the screen to view. DO NOT OPERATE the MAXXFAN with the screen removed.

CAUTIONS AND CARE OF YOUR MAXXFAN®

This product has been manufactured using prime UV stabilized Polymers for maximum toughness and durability. However, the use of caustic or solvent based chemicals can cause cracking and product failure.

PLEASE CLEAN ALL PARTS WITH MILD SOAP AND WATER ONLY.

Do not use Petroleum Containing Additives or Solvent Based Products on any of the MAXXFAN's components or its corrosion resistant hardware.

LISTED BELOW ARE SOME KNOWN CHEMICAL PRODUCTS TO BE AWARE OF:

NON COMPATIBLE CHEMICALS - DO NOT USE THESE:

Ketones, Esters, Acetone or other like solvents, Halogenated Hydrocarbons, Amines, Aromatic Hydrocarbons, (Loctite Formulas), or any products containing references to: chemicals that are not to be used on plastics.

GENERALLY COMPATIBLE (But should be used in low concentration where possible)

Acids, Alcohol, Alkalis, Aliphatic Hydrocarbons, Mild Soap Solution (avoid strong Alkaline Material), Silicone Oil or Greases (avoid those containing Aromatic Hydrocarbons or other additives). Review the contents of your cleaning materials carefully.

*For additional information regarding your **NEW MAXXFAN®** or **MAXXFAN® Plus**, please refer to the **INFORMATION AND OPERATION GUIDES FOR YOUR PARTICULAR MODEL ON THE FOLLOWING PAGES.***

INFORMATION AND OPERATING GUIDE FOR MAXXFAN® MANUAL OPENING KEYPAD MODELS 4301K • 4401K

KNOB, VENT LID OPEN/CLOSE

Manual Opening

Pull to unlock prior to turning. Rotate Knob clockwise to Close Vent Lid; Rotate Knob counter-clockwise to Open Vent Lid. Push "IN" to lock when Vent Lid is open or closed. It may be necessary to slightly rotate the knob to properly align it while pushing it up to lock.

Do not use excessive force when operating Knob.

KEYPAD CONTROLS

Use Keys on Keypad to control MAXXFAN functions (see descriptions below).

INSECT SCREEN RETAINER KNOB

Rotate all 4 knobs 1/2 turn to remove screen.

Caution: Never operate fan with screen removed.

CEILING FAN MODE

With the fan motor running, close the Vent Lid to enter Ceiling Fan Mode. The fan motor will continue to run and circulate air within the RV cabin.

SERIAL NUMBER LABEL

The serial number label is located underneath the round insect screen.

NOTE: The MAXXFAN is designed to be fully opened or fully closed when the vehicle is moving.



KEYPAD CONTROLS

FOR MAXXFAN® MANUAL OPENING KEYPAD MODELS 4301K • 4401K

CAUTION: When removing insect screen for cleaning, turn the MAXXFAN OFF and remove the vehicle 12 volt power to the MAXXFAN. When cleaning your MAXXFAN, use only a mild detergent solution.

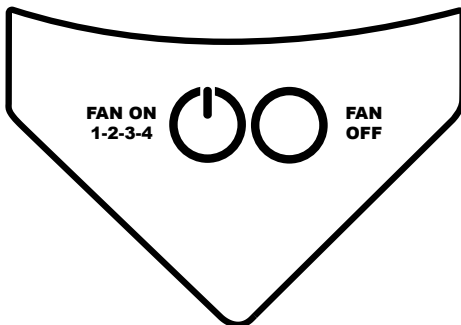

FAN ON
1-2-3-4

Turns the Fan Motor ON to the last selected speed

When the fan is running, cycles through four (4) speeds, once **HIGH SPEED** is reached, fan motor cycles back to **LOW SPEED**



FAN OFF

Turns the Fan Motor OFF at any selected speed

INFORMATION AND OPERATING GUIDE

FOR MAXXFAN® Plus MODELS

4000K • 4001K • 4050K • 4500K • 4501K • 4801K

KNOB, VENT LID OPEN/CLOSE

Manual Opening Models

Pull to unlock prior to turning. Rotate Knob clockwise to Close Vent Lid; Rotate Knob counter-clockwise to Open Vent Lid. Push "IN" to lock when Vent Lid is open or closed.

Automatic Opening Models

Allows closing of the vent lid in the event of RV power loss. This knob does not lock. Do not push in or pull out. Rotate knob clockwise to close vent lid; rotate knob counter-clockwise to open vent lid.

Do not use excessive force when operating Knob.

KEYPAD CONTROLS

Use Keys on Keypad to control MAXXFAN functions (see descriptions on next page).

INSECT SCREEN RETAINER KNOB

Rotate all 4 knobs 1/2 turn to remove screen.

CAUTION: *Never operate fan with screen removed. When removing screen for cleaning, turn the MAXXFAN OFF and remove the vehicle 12 volt power to the MAXXFAN. When cleaning your MAXXFAN, use only a mild detergent solution.*

RAIN SENSOR - Automatic Models only. If the Rain Sensor circuit detects moisture, it will TURN OFF the fan and close the lid. If ANY key is pressed when the Rain Sensor is still wet, the fan will BEEP THREE (3) TIMES. Press the FAN ON key to restart the fan after the Rain Sensor has dried.

CAUTION: If the lid is opened MANUALLY, the RAIN SENSOR will not close the MAXXFAN lid.

CEILING FAN MODE

With the fan motor running, close the Vent Lid to enter Ceiling Fan Mode. The fan motor will continue to run and circulate air within the RV cabin.

SERIAL NUMBER LABEL

The serial number label is located underneath the round insect screen.

NOTE: The MAXXFAN is designed to be fully opened or fully closed when the vehicle is moving.

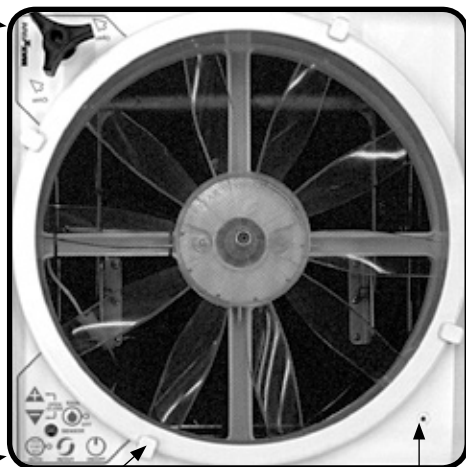

**THERMOSTAT
TEMPERATURE SENSOR**

KEYPAD CONTROLS FOR MAXXFAN® Plus MODELS 4000K • 4001K • 4050K 4500K • 4501K • 4801K

NOTE: A beeping sound will confirm each key press

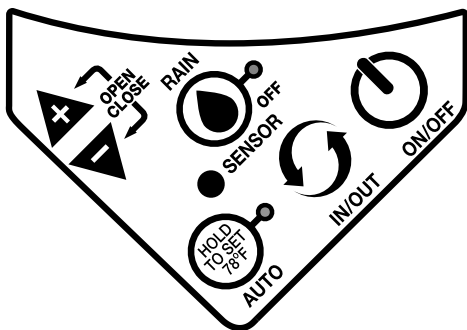

ON/OFF

ON/OFF: Use this key to start the fan or to turn off the fan. On Automatic Opening Models the lid will also open or close when the fan is turned on or off. On Manual Opening Models pushing this key while in Auto Mode will exit Auto Mode, turn off the fan and the lid will stay in the position you selected. On Automatic Opening Models this button will exit Auto mode, turn the fan off, and close the lid.



IN/OUT

IN/OUT: Use this key to reverse the direction of the fan, the fan will slow down and pause for two (2) seconds before resuming operation in the opposite direction. **Note:** In Auto Mode the fan direction is automatically positioned to Exhaust, but may be overridden and changed to Intake by depressing this key. **Note:** Some models are Exhaust Only. On these models this key is deleted.



AUTO

AUTO: Auto Mode allows the thermostat to turn the fan **ON and OFF** depending on the thermostat setting. Press this key once for less than three (3) seconds to enter Auto Mode, three (3) quick beeps will confirm the MAXXFAN has entered Auto Mode. To EXIT Auto Mode, press the **ON/OFF** key. Initial factory set point for the thermostat is 78°F. The green LED will light to indicate the MAXXFAN is in Auto Mode. To adjust, follow instructions below:

If no previous thermostat temperature was entered, or you wish to change a previous set temperature, press the HOLD TO SET key for more than 3 seconds and you will hear one long beep and the thermostat will be reset to 78°F. To further adjust the set temperature, if desired, use the (+) or (-) Arrow keys to adjust at 1°F per press. The fan will emit a beeping sound to confirm this setting. If a previous thermostat temperature was entered, the fan will remember this temperature setting and the next time you enter Auto Mode, the fan will start ventilating automatically as directed by the thermostat. The fan speed will automatically adjust based on the cabin temperature. As cabin temperature rises, the fan increases in speed. **Note:** If 12 volt RV power is removed from the MAXXFAN, the thermostat will be reset to 78°F.



ARROW

When in Auto Mode: Use the (+) & (-) Arrow keys to adjust the thermostat set temperature up or down by 1°F per press.

When in Manual Mode: Use the (+) & (-) Arrow keys to adjust the fan speed up or down. When the fan speed reaches either the maximum or minimum speed, the fan will respond with 2 quick beeps to indicate this.

ARROW KEYS PRESSED TOGETHER: *Automatic Lift Models Only*

Press the (+) & (-) Arrow keys at the same time to Open or Close the lid. The fan motor will remain in its current state.



RAIN SENSOR: *Automatic Opening Models Only*

Press this key to turn the Rain Sensor OFF. This will deactivate the Rain Sensor. The red LED will light to indicate that the Rain Sensor is deactivated. Use caution when deactivating the Rain Sensor as rain could enter your RV. If the Rain Sensor circuit detects rain, it will turn off the fan and close the lid. The red LED will blink to indicate that the Rain Sensor has shut the fan off. Press the Rain Sensor key again to reset the fan and extinguish the blinking LED. **Note:** CAUTION, the Rain Sensor will not close the MAXXFAN lid if the lid is opened manually with the knob.

REMOTE CONTROL OPERATING GUIDE

WIRELESS REMOTE CONTROL FOR MAXXFAN® Plus MODELS: 4500K • 4501K



FAN
ON/OFF

FAN ON & POWER OFF - Press this button:

- To start the fan
- To turn the fan off
- To exit Auto Mode



VENT LID POSITION - Press this button to open or close the vent lid

- While the fan is running in Manual Mode press once to close the vent lid and enter "Ceiling Fan" Mode.

NOTE: This button is not active in Auto Mode. If the fan loses 12volt RV power or power is removed from the fan, use the knob located at the ceiling to manually open or close the vent lid if desired.



AIR EXHAUST / INTAKE - Press this button to reverse the fan from intake or exhaust

NOTE: In Auto Mode, the fan direction is automatically positioned to Exhaust, but may be overridden and changed to Intake by depressing this key.



FAN AUTO MODE - Press this button to enter Auto Mode

- Auto Mode allows the fan lid to automatically open and the fan motor to operate as dictated by the thermostat set point temperature. Once the cabin temperature cools and reaches the set point temperature, the fan lid will close and the fan motor will shut off.
- Pressing this button while in Auto Mode will shut off Auto Mode, close the vent lid and shut off the fan motor.



THERMOSTAT SET TEMPERATURE

TEMP + ~ Press this button to increase the Set Temperature for Auto Mode.

TEMP - ~ Press this button to decrease the Set Temperature for Auto Mode.

NOTE: The thermostat ranges is from 29°F to 99°F or -2°C to 37°C. To change from Fahrenheit to Celsius on the temperature display, press and hold both set temperature keys simultaneously.



FAN SPEED

Fan Speed + ~ Press this button to increase the fan speed. The fan has ten speeds.

Fan Speed - ~ Press this button to decrease the fan speed. The fan has ten speeds.

NOTE: When the fan speed reaches either the maximum or minimum speed, the fan will respond with 2 quick beep sounds to indicate this.



LOW BATTERY INDICATOR

- When the battery is at full charge, three black power bars are displayed.
- One or zero power bars displayed indicates the batteries need replacement.



TRANSMISSION SIGNAL

- This symbol is displayed on the screen when any button is pressed to indicate the signal was transmitted to the fan.
- A beep sound from the ceiling unit indicates the signal from the remote control was received by the fan.

Remove protective film from
Display Screen

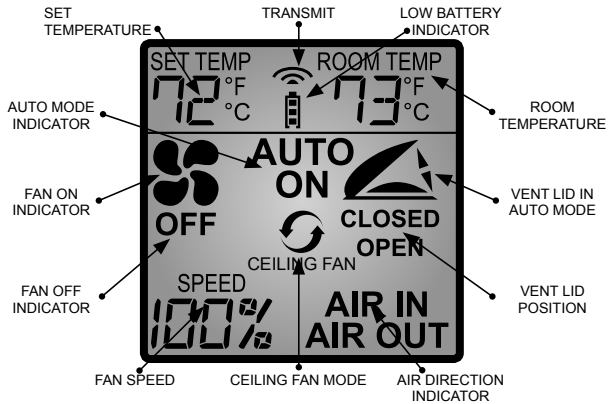

ENJOY your new **MAXXFAN®** in **ALL WEATHER CONDITIONS** with the **NEW FANMATE®** featuring **EZClip™** Hardware for **TOOL FREE INSTALLATION**. Visit **AIRXCEL.com** for details.



For additional product information please visit www.AIRXCEL.com
AIRXCEL, INC. - RV Products Division / MAXXAIR
3050 N. St. Francis St. • Wichita, KS 67219 • 316-832-3400

