



User Manual

English

APC Smart-UPS®

2200/3000 VA  
100/120/230 VAC

Tower  
Uninterruptible Power Supply



## Introduction

---

### About this UPS

The APC Uninterruptible Power Supply (UPS) is designed to prevent utility power blackouts, brownouts, sags and surges from reaching your electronic equipment. The uninterruptible power supply (UPS) filters small utility line fluctuations and isolates your electronic equipment from large disturbances by internally disconnecting from the utility line. The UPS provides continuous power from the internal battery until utility power returns to safe levels or the battery is fully discharged.

## Installation

---

### Unpack

**Read the Safety Guide before installing the UPS.**

Inspect the UPS upon receipt. Notify the carrier and dealer if there is damage.

The packaging is recyclable; save it for reuse or dispose of it properly.

Check the package contents:

- |   |  |  |
|---|--|--|
| <ul style="list-style-type: none"> <li>• UPS</li> <li>• EPO connector</li> <li>• UPS literature kit containing:               <ul style="list-style-type: none"> <li>– product documentation</li> <li>– safety information</li> <li>– warranty information</li> </ul> </li> </ul> | <p><i>120/230 V models:</i></p> <p>UPS literature kit additional contents:</p> <ul style="list-style-type: none"> <li>• Smart-UPS® User Manuals CD</li> <li>• PowerChute® CD</li> <li>• Serial and USB communication cables</li> </ul> | <p><i>230V models:</i></p> <p>UPS literature kit additional contents:</p> <ul style="list-style-type: none"> <li>• input power cord</li> <li>• alternate input power cord (UK customers)</li> <li>• utility connector plug</li> <li>• IEC jumper cables</li> </ul> |
|---|--|--|

### Position the UPS in the Specified Environment

The UPS is heavy. Select a location sturdy enough to handle the weight.

Do not operate the UPS where there is excessive dust or the temperature or humidity are outside the specified limits:

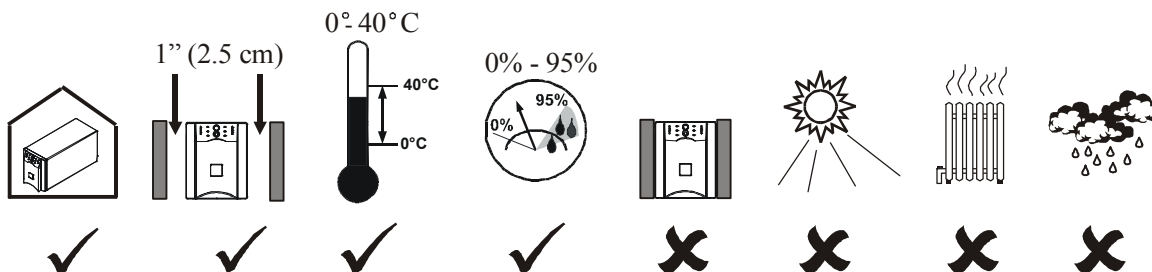

## Connect the Battery Module

Insert the battery connector into the battery jack and push firmly, twice. You will feel a snap as the connector partially engages the jack. Push firmly a second time. You will feel a second snap as the connector securely seats in the battery jack.

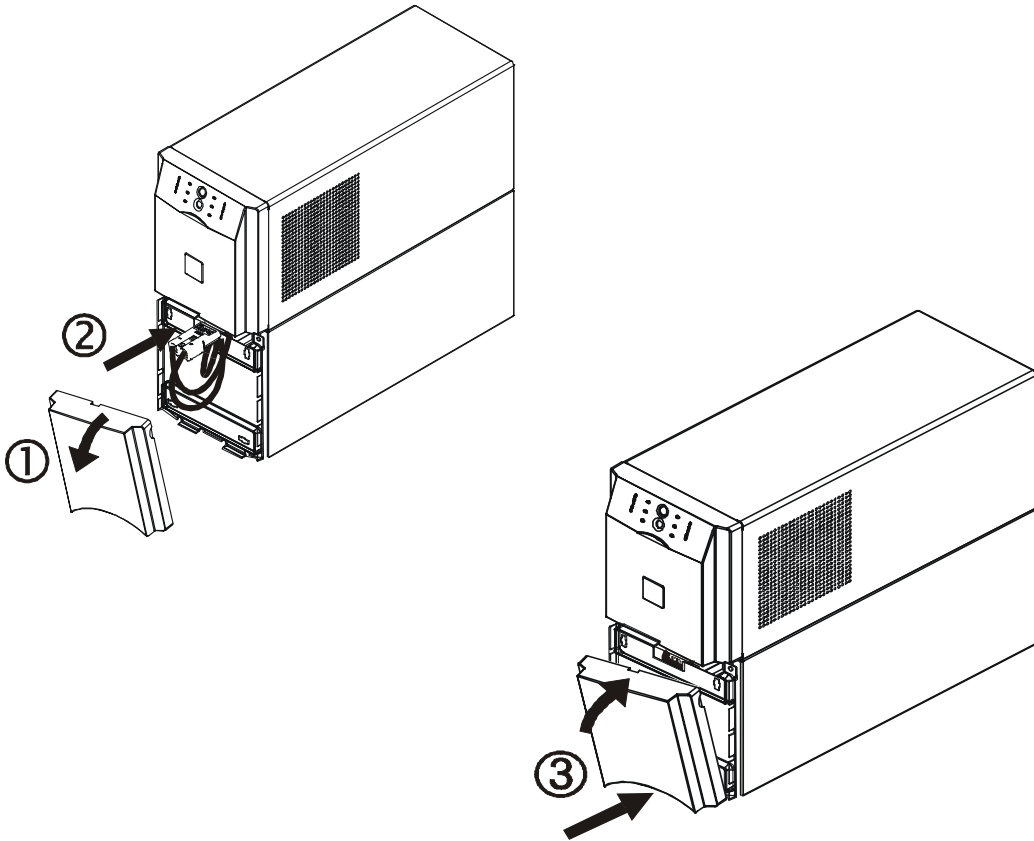

## Start Up

### Connect Equipment and Power to the UPS

1. The UPS features a transient voltage surge-suppression (TVSS) screw  located on the rear panel, for connecting the ground lead on surge suppression devices such as telephone and network line protectors.

**Prior to connecting the grounding cable, ensure that the UPS is NOT connected to utility or battery power.**

2. Connect equipment to the UPS.
3. Add optional accessories to the Smart-Slot.
4. Plug the UPS into a two-pole, three-wire, grounded receptacle only. Avoid using extension cords.
  - *230 V models:* The utility power cord is supplied in the UPS literature kit. Prior to connecting the utility power, connect the ground lead (optional) to the TVSS screw.
5. *120 V models:* Check the *SITE WIRING FAULT* LED  located on the rear panel. It will be illuminated if the UPS is plugged into an improperly wired utility power outlet, (see *Troubleshooting*).
6. Turn on all connected equipment. To use the UPS as a master on/off switch. Be sure all connected equipment is switched on.

### Rear Panels

100/120 VAC 2200 VA

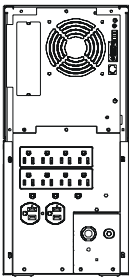

100/120 VAC 3000 VA

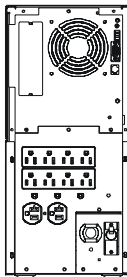

230 VAC 2200/3000 VA

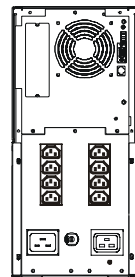

### Start the UPS

1. Press the  button on the front panel to start the UPS.
  - The battery charges to 90% capacity during the first four hours of normal operation. *Do not* expect full battery run capability during this initial charge period.
  - Refer to the APC Web site, [www.apc.com](http://www.apc.com) for battery runtimes.
2. For optimal computer system security, install PowerChute Smart-UPS monitoring software.

## Connect the UPS to the Network (if Applicable)

### Communication Ports

SERIAL PORT

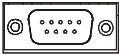

USB PORT



**120/230 V models:** Use only the supplied cable to connect to the serial port. A standard serial interface cable is incompatible with the UPS.

**100 V models:** Users may purchase software and cables as an accessory to the UPS. Refer to the APC Web site, [www.apc.com](http://www.apc.com) for information on accessories.

Serial and USB ports cannot be used simultaneously.

## Emergency Power Off

The emergency power off (EPO) feature is user configurable. EPO provides immediate de-energizing of connected equipment from a remote location, without switching to battery operation.

1. Use the EPO connector supplied with the UPS.
2. Use a normally-open contact to connect the +24 terminal to the IN terminal.
3. Wire the four-pin connector to the EPO system.

**EPO PORT**  
(located on rear panel)



**EPO Connector**

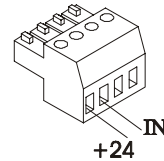

**The EPO interface is a Safety Extra Low Voltage (SELV) circuit. Connect it only to other SELV circuits. The EPO interface monitors circuits that have no determined voltage potential. Such closure circuits may be provided by a switch or relay properly isolated from the utility. To avoid damage to the UPS, do not connect the EPO interface to any circuit other than a closure type circuit.**

Use one of the following cable types to connect the UPS to the EPO switch.

- CL2: Class 2 cable for general use.
- CL2P: Plenum cable for use in ducts, plenums, and other spaces used for environmental air.
- CL2R: Riser cable for use in a vertical run in a floor-to-floor shaft.
- CLEX: Limited use cable for use in dwellings and for use in raceways.
- For installation in Canada: Use only CSA certified, type ELC, (extra-low voltage control cable).
- For installation in other countries: Use standard low-voltage cable in accordance with national and local regulations.



## Operation

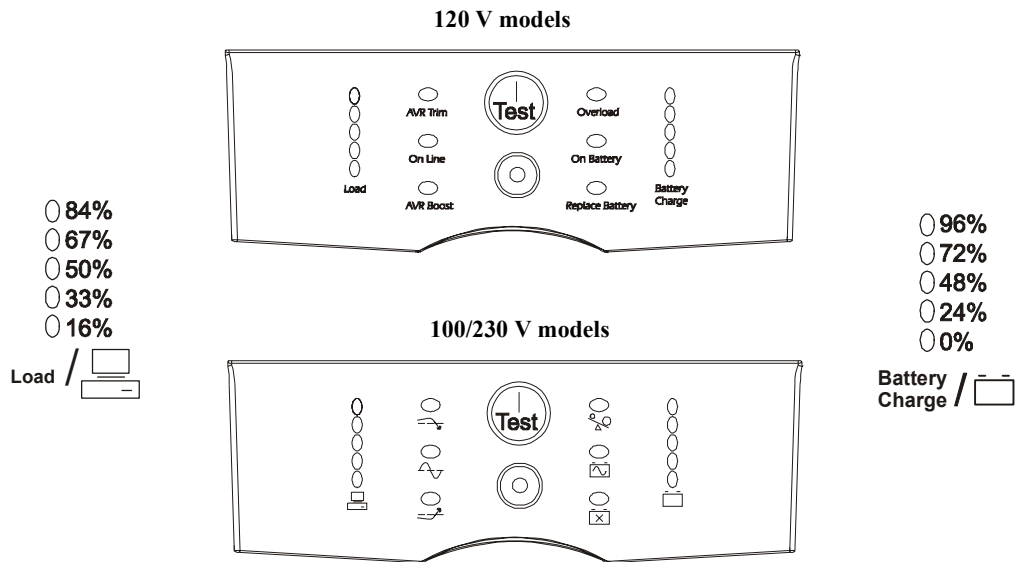



### Display Panels



### Display Panel Indicators and Function Buttons

Indicator LED	Indicator Title	Description
	On Line	The UPS is supplying utility power to the connected equipment, (see <i>Troubleshooting</i> ).
	AVR Trim	The UPS is compensating for a high utility voltage.
	AVR Boost	The UPS is compensating for a low utility voltage.
	On Battery	The UPS is supplying battery power to the connected equipment.
	Overload	The connected equipment is drawing more than the UPS power rating allows, (see <i>Troubleshooting</i> ).
	Replace Battery/Battery Disconnected	The battery is disconnected or must be replaced, (see <i>Troubleshooting</i> ).

<p><b>100V</b></p> <ul style="list-style-type: none"> <li>○ 119</li> <li>○ 109</li> <li>○ 100</li> <li>○ 91</li> <li>○ 81</li> </ul> <p><b>230V</b></p> <ul style="list-style-type: none"> <li>○ 266</li> <li>○ 248</li> <li>○ 229</li> <li>○ 210</li> <li>○ 191</li> </ul> <p>□      □</p> <p><b>120V</b></p> <ul style="list-style-type: none"> <li>○ 133</li> <li>○ 123</li> <li>○ 115</li> <li>○ 105</li> <li>○ 98</li> </ul> <p><b>Battery Charge</b></p>	<p>Diagnostic Utility Voltage</p>	<p>The UPS has a diagnostic feature that indicates the utility voltage. The UPS starts a self-test as part of this procedure. The self-test does not affect the voltage display.</p> <p>Press and hold the  button to view the utility voltage bar graph indicator.</p> <p>After a few seconds, this five-LED <i>Battery Charge</i>  indicator on the right of the display panel will show the utility input voltage.</p> <p>Refer to the figure on the left for the voltage reading, (values are not listed on the UPS).</p> <p>The indicator on the UPS shows the voltage is between the displayed value on the list and the next higher value, (see <i>Troubleshooting</i>).</p>
--	-----------------------------------	---





Feature Button	Feature Title	Function
	Power On	Press this button to turn on the UPS. Continue reading for additional capabilities.
	Power Off	Press this button to turn off the UPS.
	Self-Test	<p><b>Automatic:</b> The UPS performs a self-test automatically when tuned on, and every two weeks thereafter (by default). During the self-test, the UPS briefly operates the connected equipment on battery.</p> <p><b>Manual:</b> Press and hold the  button for a few seconds to initiate the self-test.</p>
	Cold Start 120/230 V Models	When there is no utility power and the UPS is off, the cold start feature will switch the UPS and connected equipment onto battery power, (see <i>Troubleshooting</i> ).









## Configuration

### UPS settings

Settings are adjusted through PowerChute software or optional Smart Slot accessory cards.

Function	Factory Default	User Selectable Choices	Description
Automatic Self-Test	Every 14 days (336 hours)	<ul style="list-style-type: none"> <li>• Every 7 days (168 hours)</li> <li>• On start up only</li> <li>• No self-test</li> </ul>	Set the interval at which the UPS will execute a self-test.
UPS ID	UPS_IDEN	Up to eight characters (alphanumeric)	Uniquely identify the UPS, (i.e. server name or location) for network management purposes.
Date of Last Battery Replacement	Manufacture Date	mm/dd/yy	Reset this date when you replace the battery module.
Minimum Capacity Before Return from Shutdown	0 percent	<ul style="list-style-type: none"> <li style="width: 50%;">• 0%</li> <li style="width: 50%;">• 50%</li> <li style="width: 50%;">• 15%</li> <li style="width: 50%;">• 60%</li> <li style="width: 50%;">• 30%</li> <li style="width: 50%;">• 75%</li> <li style="width: 50%;">• 45%</li> <li style="width: 50%;">• 90%</li> </ul>	Specify the percentage to which batteries will be charged following a low battery shutdown before powering connected equipment.
Voltage Sensitivity The UPS detects and reacts to line voltage distortions by transferring to battery operation to protect the connected equipment.	High sensitivity 	 Brightly illuminated: high sensitivity  Dimly illuminated: medium sensitivity  No illumination: low sensitivity	Adjust by pressing the <i>VOLTAGE SENSITIVITY</i> switch  (rear panel). Use a pointed object, (such as a pen) to do so. Note: In situations of poor power quality, the UPS may frequently transfer to battery operation. If the connected equipment can operate normally under such conditions, reduce the sensitivity setting to conserve battery capacity and service life.
Alarm Delay Control	Enable	<ul style="list-style-type: none"> <li>• Enable</li> <li>• Mute</li> <li>• Disable</li> </ul>	Mute ongoing alarms or disable all alarms permanently.
Shutdown Delay	90 seconds	<ul style="list-style-type: none"> <li style="width: 50%;">• 0 s</li> <li style="width: 50%;">• 360 s</li> <li style="width: 50%;">• 90 s</li> <li style="width: 50%;">• 450 s</li> <li style="width: 50%;">• 180 s</li> <li style="width: 50%;">• 540 s</li> <li style="width: 50%;">• 270 s</li> <li style="width: 50%;">• 630 s</li> </ul>	Set the interval between the time when the UPS receives a shutdown command and actual shutdown.

Function	Factory Default	User Selectable Choices	Description
<p>Low Battery Warning</p>	<p> 2 minutes</p> <p>PowerChute software interface provides automatic, unattended shutdown when approximately two minutes of battery operated run time remains.</p>	<p> <i>Brightly illuminated:</i> low battery warning level of about 2 minutes</p> <p> <i>Dimly illuminated:</i> low battery warning level of about 5 minutes</p> <p> <i>No illumination:</i> low battery warning level is about 8 minutes</p>	<p>The low-battery warning beeps are continuous when two minutes of run time remain.</p> <p>To change the default interval setting, use a pointed object such as a pen to press the <i>VOLTAGE SENSITIVITY</i> switch  (rear panel), while pressing the  button, (front display).</p> <p>Change the low battery warning interval setting to the time that the operating system or system software requires to safely shut down.</p>
<p>Synchronized Turn-on Delay</p>	<p>0 seconds</p>	<ul style="list-style-type: none"> <li>• 0 s</li> <li>• 60 s</li> <li>• 120 s</li> <li>• 180 s</li> <li>• 240 s</li> <li>• 300 s</li> <li>• 360 s</li> <li>• 420 s</li> </ul>	<p>Specify the time the UPS will wait after the return of utility power before start up, (to avoid branch circuit overload).</p>
<p>High Transfer Point</p>	<p><i>100 V models:</i> 108 VAC</p> <p><i>120 V models:</i> 127 VAC</p> <p><i>230 V models:</i> 253 VAC</p>	<ul style="list-style-type: none"> <li>• 108 VAC</li> <li>• 110 VAC</li> <li>• 112 VAC</li> <li>• 114 VAC</li> <li>• 127 VAC</li> <li>• 130 VAC</li> <li>• 133 VAC</li> <li>• 136 VAC</li> <li>• 253 VAC</li> <li>• 257 VAC</li> <li>• 261 VAC</li> <li>• 265 VAC</li> </ul>	<p>To avoid unnecessary use of the battery where utility voltage is chronically high, set the high transfer point higher if the connected equipment can tolerate this condition.</p>
<p>Low Transfer Point</p>	<p><i>100 V models:</i> 92 VAC</p> <p><i>120 V models:</i> 106 VAC</p> <p><i>230 V models:</i> 208 VAC</p>	<ul style="list-style-type: none"> <li>• 86 VAC</li> <li>• 88 VAC</li> <li>• 90 VAC</li> <li>• 92 VAC</li> <li>• 97 VAC</li> <li>• 100 VAC</li> <li>• 103 VAC</li> <li>• 106 VAC</li> <li>• 196 VAC</li> <li>• 200 VAC</li> <li>• 204 VAC</li> <li>• 208 VAC</li> </ul>	<p>To avoid unnecessary use of the battery where utility voltage is chronically low, set the low transfer point lower if the connected equipment can tolerate this condition.</p>
<p>Output Voltage 230 V models</p>	<p>230 VAC</p>	<ul style="list-style-type: none"> <li>• 220 VAC</li> <li>• 240 VAC</li> </ul>	<p><i>230 V models only:</i> Sets the output voltage of the UPS.</p>

## Storage, Maintenance, Transport, and Service

---

### Storage

Store the UPS covered in a cool, dry location with the batteries fully charged.

At 5° to 86° F (–15° to 30° C), charge the UPS battery every six months.

At 86° to 113° F (30° to 45° C), charge the UPS battery every three months.

### Replacing the Battery Module

This UPS has an easy-to-replace, hot-swappable battery module. Replacement is a safe procedure, isolated from electrical hazards. You may leave the UPS and connected equipment on during the replacement procedure.

**Once the batteries are disconnected the connected equipment is not protected from power outages.**

Refer to the appropriate replacement battery user manual for battery module installation instructions. See your dealer or contact APC at [www.apc.com/support](http://www.apc.com/support) for information on replacement battery modules.

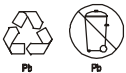

**Be sure to deliver the spent battery(s) to a recycling facility or ship it to APC in the replacement battery packing material.**



### Service

If the UPS requires service do not return it to the dealer. Follow these steps:



1. Review the problems discussed in *Troubleshooting* to eliminate common problems.
2. If the problem persists, contact APC Customer Service through the APC Web site, [www.apc.com/support](http://www.apc.com/support).
  - Note the model number of the UPS, the serial number, and the date purchased. If you call APC Customer Service, a technician will ask you to describe the problem and attempt to solve it over the phone. If this is not possible, the technician will issue a Returned Material Authorization Number (RMA#).
  - If the UPS is under warranty, repairs are free.
  - Procedures for servicing or returning products may vary internationally. Refer to the APC Web site for country specific instructions.
3. Pack the UPS in its original packaging. If this is not available, refer to [www.apc.com/support](http://www.apc.com/support) for information about obtaining a new set.
  - Pack the UPS properly to avoid damage in transit. Never use Styrofoam beads for packaging. Damage sustained in transit is not covered under warranty.
  - **Always DISCONNECT THE BATTERY before shipping in compliance with U.S. Department of Transportation (DOT) and IATA regulations.** The battery may remain in the UPS.
4. Mark the RMA# on the outside of the package.
5. Return the UPS by insured, prepaid carrier to the address given to you by Customer Service.

## Troubleshooting

Use this chart to solve minor UPS installation and operation problems. Refer to [www.apc.com](http://www.apc.com) with complex UPS problems.

Problem and/or Possible Cause	Solution
<b>UPS will not turn on</b>	
The battery is not connected properly.	Check that the battery connector is fully engaged.
 button not pushed.	Press the  button once to power-up the UPS and connected equipment.
The UPS is not connected to utility power supply.	Check that the power cable from the UPS to the utility power supply is securely connected at both ends.
Very low or no utility voltage	Check the utility power supply to the UPS by plugging in a table lamp. If the light is very dim, have the utility voltage checked.
<b>UPS will not turn off</b>	
The UPS is experiencing an internal fault	Do not attempt to use the UPS. Unplug the UPS and have it serviced immediately.
<b>UPS beeps occasionally</b>	
Normal UPS operation when running on battery.	None: The UPS is protecting the connected equipment. Press the  button to silence this alarm.
<b>UPS is not providing expected backup time</b>	
The UPS battery(s) are weak due to a recent power outage or battery(s) are near the end of their service life.	Charge the battery(s). Batteries require recharging after extended outages. Batteries can wear faster when put into service often or when operated at elevated temperatures. If the battery(s) are near the end of their service life, consider replacing the battery(s) even if the <i>replace battery</i> LED is not yet illuminated.
<b>All LEDs are illuminated and the UPS emits a constant beeping</b>	
The UPS is experiencing an internal fault.	Do not attempt to use the UPS. Unplug the UPS and have it serviced immediately.
<b>Front panel LEDs flash sequentially</b>	
The UPS has been shut down remotely through software or an optional accessory card.	None: The UPS will restart automatically when utility power returns.

Problem and/or Possible Cause	Solution
<b>All LEDs are off and the UPS is plugged into a wall outlet</b>	
The UPS is shut down or the battery is discharged from an extended outage.	None: The UPS will restart automatically when utility power is restored and the battery has a sufficient charge.
<b>The Overload LED is illuminated and the UPS emits a sustained alarm tone</b>	
The UPS is overloaded.	<p>The connected equipment exceeds the specified “maximum load” as defined in Specifications on the APC Web site, <a href="http://www.apc.com">www.apc.com</a>.</p> <p>The alarm remains on until the overload is removed. Disconnect nonessential equipment from the UPS to eliminate the overload condition.</p> <p>The UPS continues to supply power as long as it is online and the circuit breaker does not trip; the UPS will not provide power from batteries in the event of a utility voltage interruption.</p>
<b>The Replace Battery/Battery Disconnected LED is illuminated</b>	
The <i>Replace Battery/Battery Disconnected</i> LED flashes and a short beep is emitted every two seconds to indicate the battery is disconnected.	Check that the battery connectors are fully engaged.
Weak battery	Allow the battery to recharge for 24 hours and perform a self-test. If the problem persists after recharging, replace the battery.
Failure of a battery self-test: <i>Replace Battery/Battery Disconnected</i> LED illuminates and the UPS emits short beeps for one minute. The UPS repeats the alarm every five hours.	<p>Allow the battery to recharge for 24 hours. Perform the self-test procedure to confirm the replace battery condition. The alarm stops and the LED clears if the battery passes the self-test.</p> <p>If the battery fails again, it must be replaced. The connected equipment is unaffected.</p>
<b>The Site Wiring Fault LED on the rear panel is illuminated (120 V model only)</b>	
The UPS is plugged into an improperly wired utility power outlet.	<p>Wiring faults detected include missing ground, hot-neutral polarity reversal, and overloaded neutral circuit.</p> <p>Contact a qualified electrician to correct the building wiring.</p>
<b>The input circuit breaker trips</b>	
The connected equipment exceeds the specified “maximum load” as defined in <i>Specifications</i> on the APC Web site, <a href="http://www.apc.com">www.apc.com</a> .	<p>Unplug all nonessential equipment from the UPS.</p> <p>Reset the circuit breaker.</p>
<b>The AVR Boost or AVR Trim LEDs are illuminated</b>	
The system is experiencing very high or low utility voltage.	Have a qualified service personnel check your facility for electrical problems. If the problem persists, contact the utility company for further assistance.

Problem and/or Possible Cause	Solution
<b>There is no utility power</b>	
<p>There is no utility power and the UPS is off.</p>	<p>120/230 V models: Use the cold start feature to supply power to the connected equipment front the UPS battery(s).</p> <p>Press the  button for one second and release. The UPS will beep briefly.</p> <p>Press and hold the  button again for about three seconds. The unit will emit two beeps. Release the button during the second beep.</p>
<b>UPS operates on battery although line voltage exists</b>	
<p>The UPS input circuit breaker trips.</p>	<p>Unplug all nonessential equipment from the UPS. Reset the circuit breaker.</p>
<p>Your system is experiencing very high, low or distorted line voltage.</p>	<p>Move the UPS to a different outlet on a different circuit: Inexpensive fuel powered generators may distort the voltage. Test the input voltage with the utility voltage display, (see <i>Operation</i>). If acceptable to the connected equipment, reduce the UPS sensitivity.</p>
<b>Battery Charge and Load LEDs flash simultaneously</b>	
<p>The UPS has shut down. The internal temperature of the UPS has exceeded the allowable threshold for safe operation.</p>	<p>Check that the room temperature is within the specified limits for operation. Check that the UPS is properly installed, allowing for adequate ventilation. Allow the UPS to cool down. Restart the UPS. If the problem persists, contact APC at <a href="http://www.apc.com">www.apc.com</a>.</p>
<b>Diagnostic utility voltage</b>	
<p>All five LEDs are illuminated.</p>	<p>The line voltage is extremely high and should be checked by an electrician.</p>
<p>There is no LED illumination.</p>	<p>The line voltage is extremely high and should be checked by an electrician.</p>
<b>On Line LED</b>	
<p>There is no LED illumination.</p>	<p>The UPS is running on battery, or it must be turned on.</p>
<p>The LED is blinking.</p>	<p>The UPS is running an internal self-test.</p>

## Regulatory and Warranty Information

### Regulatory Agency Approvals and Radio Frequency Warnings

#### FCC Compliance Notice

This equipment has been tested and found to comply with the limits for a Class A digital device, pursuant to part 15 of the FCC Rules. These limits are designed to provide reasonable protection against harmful interference when the equipment is operated in a commercial environment. This equipment generates, uses, and can radiate radio frequency energy. If it is not installed and used in accordance with the instruction manual, it may cause harmful interference to radio communications. Operation of this equipment in a residential area is likely to cause harmful interference in which case users will be required to take whatever measures may be necessary to correct the interference at their own expense.

#### 120 V models



BSMI



**警告使用者:**  
 這是甲類的資訊產品，在居住的環境中使用時，可能會造成射頻干擾，在這種情況下，使用者會被要求採取某些適當的對策。

#### 100 V models



この装置は、情報処理装置等電波障害自主規制協議会（VCCI）の基準に基づくクラス A 情報技術装置です。この装置を家庭環境で使用すると電波妨害を引き起こすことがあります。この場合には使用者が適切な対策を講ずるよう要求されることがあります。

#### 230 V models



**EC Declaration of Conformity**Date of product declaration **2004**

**We, the undersigned, declare under our sole responsibility that the equipment specified below conforms to the following standards and directives:**

**Standards to Which Conformity Declared:**

EN62040-1-1; EN55022; EN55024;  
EN61000-3-2, 3-3, 4-2, 4-4, 4-5, 4-6, 4-8, 4-11;  
EN60950; IEC60950-1

**Application of Council Directives:**

73/23/EEC; 93/68/EEC

**Type of Equipment:**

PowerSupply

**Model Numbers:**

SUA2200I; SUA3000I

**Importer's Name and Address:**

American Power Conversion  
Ballybritt Business Park  
Galway, Ireland

**Place:** **Ray S. Ballard Managing Director, Europe**

Galway, Ireland



5 Jan 04

**Place:** **Richard J. Everett Sr. Regulatory Compliance Engineer**

N. Billerica, MA  
USA



5 Jan 04

**Manufacturer's Name and Address:**

American Power Conversion (A.P.C.)  
Ballybritt Business Park.  
Galway, Ireland

American Power Conversion  
132 Fairgrounds Rd.  
West Kingston, RI 02892 USA

APC (Suzhou) UPS Co.,Ltd  
339 Suhong Zhong Lu  
Suzhou Industrial Park  
Suzhou Jiangau 2215021  
P. R. China

APC India Pvt, Ltd.  
187/3, 188/3, Jigani Industrial Area  
Bangaldore, 562106  
Kanataka  
India

American Power Conversion  
Lot 3, Block 14, Phase 3  
PEZA, Rosario, Cavite  
Philippines

American Power Conversion  
2nd Street  
PEZA, Cavite Economic Zone  
Rosario, Cavite  
Philippines

American Power Conversion  
Lot 10, Block 16, Phase 4  
PEZA, Rosario, Cavite  
Philippines

APC Brasil LTDA.  
Al.Xingu, 850  
Barueri  
Alphaville/Sao Paulo  
06455-030  
Brazil

**Limited Warranty**

American Power Conversion (APC) warrants its products to be free from defects in materials and workmanship for a period of two years from the date of purchase. Its obligation under this warranty is limited to repairing or replacing, at its own sole option, any such defective products. To obtain service under warranty you must obtain a Returned Material Authorization (RMA) number from customer support. Products must be returned with transportation charges prepaid and must be accompanied by a brief description of the problem encountered and proof of date and place of purchase. This warranty does not apply to equipment that has been damaged by accident, negligence, or misapplication or has been altered or modified in any way. This warranty applies only to the original purchaser who must have properly registered the product within 10 days of purchase.

EXCEPT AS PROVIDED HEREIN, AMERICAN POWER CONVERSION MAKES NO WARRANTIES, EXPRESSED OR IMPLIED, INCLUDING WARRANTIES OF MERCHANTABILITY AND FITNESS FOR A PARTICULAR PURPOSE. Some states do not permit limitation or exclusion of implied warranties; therefore, the aforesaid limitation(s) or exclusion(s) may not apply to the purchaser.

EXCEPT AS PROVIDED ABOVE, IN NO EVENT WILL APC BE LIABLE FOR DIRECT, INDIRECT, SPECIAL, INCIDENTAL, OR CONSEQUENTIAL DAMAGES ARISING OUT OF THE USE OF THIS PRODUCT, EVEN IF ADVISED OF THE POSSIBILITY OF SUCH DAMAGE. Specifically, APC is not liable for any costs, such as lost profits or revenue, loss of equipment, loss of use of equipment, loss of software, loss of data, costs of substitutes, claims by third parties, or otherwise.



# APC Worldwide Customer Support

---

Customer support for this or any other APC product is available at no charge in any of the following ways:

- Refer to the APC Web site to access documents in the APC Knowledge Base and to submit customer support requests.
  - **www.apc.com** (Corporate Headquarters)  
Connect to localized APC Web sites for specific countries, each of which provides customer support information.
  - **www.apc.com/support/**  
Global support searching APC Knowledge Base and using e-support.
- Contact an APC Customer Support center by telephone or e-mail.  
Local, country-specific centers:  
go to **www.apc.com/support/contact** for information.

Contact the APC representative or other distributor from whom you purchased your APC product for information on how to obtain local customer support.

Entire contents copyright 2005 American Power Conversion Corporation. All rights reserved. Reproduction in whole or in part without permission is prohibited.

APC, the APC logo, Smart-UPS and PowerChute are trademarks of American Power Conversion Corporation. All other trademarks, product names, and corporate names are the property of their respective owners and are used for informational purposes only.